



TRUCK AND VAN EQUIPMENT

LOCK RETROFIT-KIT INSTALLATION

ALUMINUM AND STEEL
SADDLE BOX / CROSS BOX / LO-SIDE BOX / SUPER-LO BOX
MODELS 114-X THRU 186-X

WWW.WEATHERGUARD.COM



PARTS LIST - PART NO. 7838 / 7892 / 7896

(Qty. 2) Replacement Lock and Keys

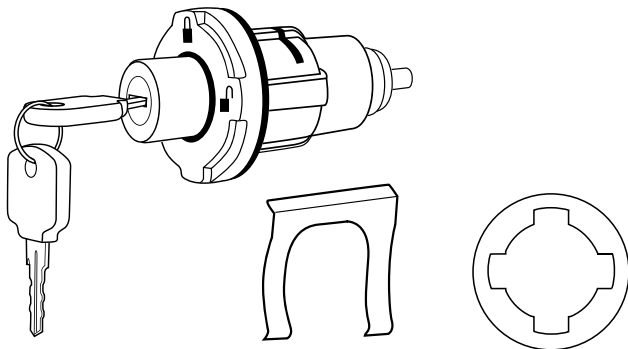

Part No. 7896 Does not include lock(s)

(Qty. 2) Cross Box, Lo-Side Box and Super-Lo Box Reinforcing Plate

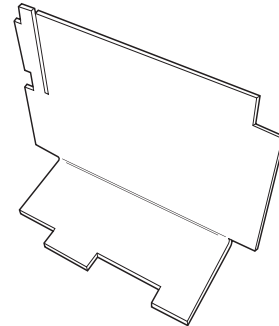

PN 21-0843

(Qty. 2) Saddle Box Reinforcing Plate

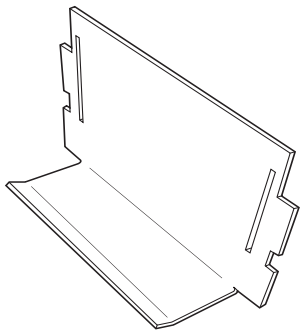

PN 21-0848

(Qty. 2) Anti-Rotation Tab

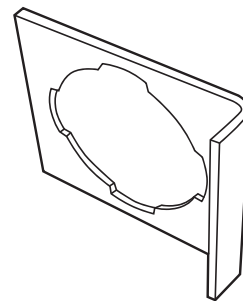

PN 21-0845

(Qty. 2) Alcohol Wipe

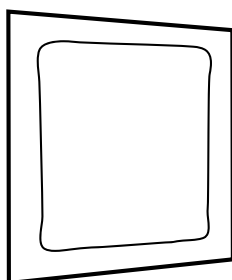

PN 21-0878

(Qty. 2) Screw



INSTALLATION INSTRUCTIONS SADDLE BOX

Figure 1. Remove screw and cover (save these, they will be reused).



Figure 2. Remove lock clip and lock.



Figure 3. Wipe area with clean rag (metal surface must be free from dirt and oil).



Figure 4. Wipe area with alcohol wipe provided and let dry.



Figure 5. Peel adhesive backing from saddle box reinforcing plate and place as shown against side and front of box (as shown by arrows); hold for one minute.

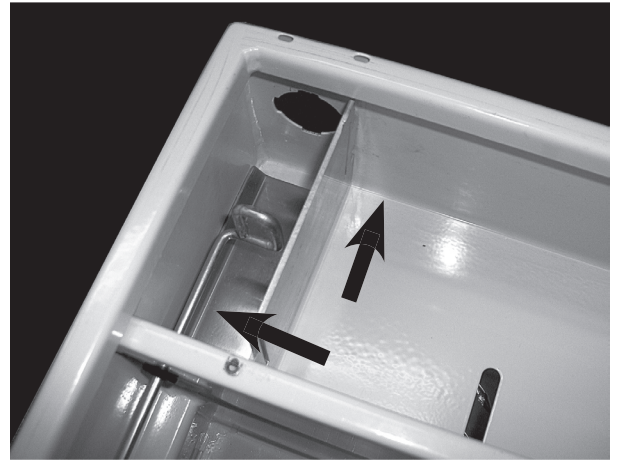

Figure 6. Insert anti-rotation tab as shown.

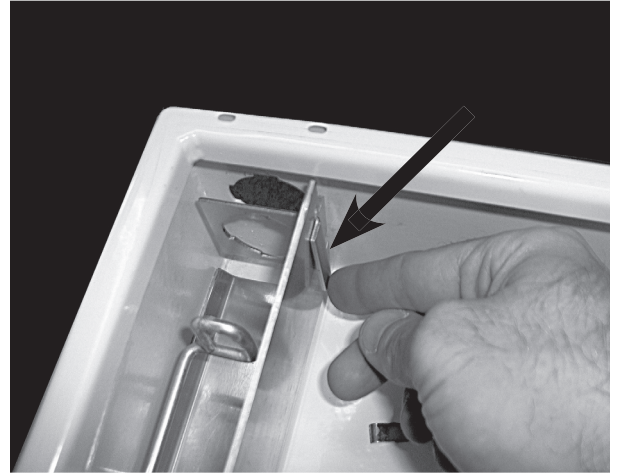

Figure 7. Insert new lock as shown.

Note: Make sure to install rubber gasket (included) between lock flange and box.

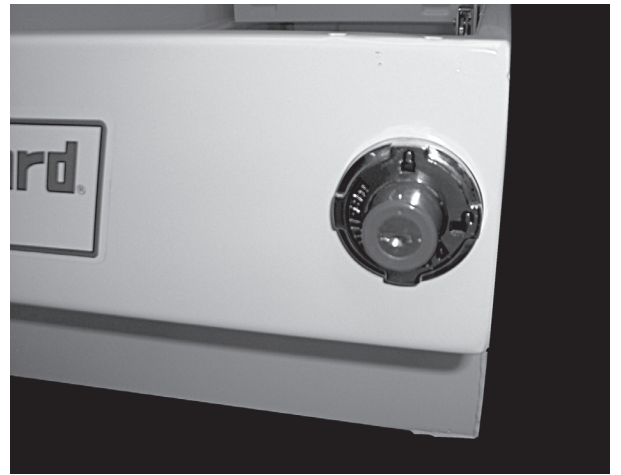

Figure 8. Insert lock clip as shown.

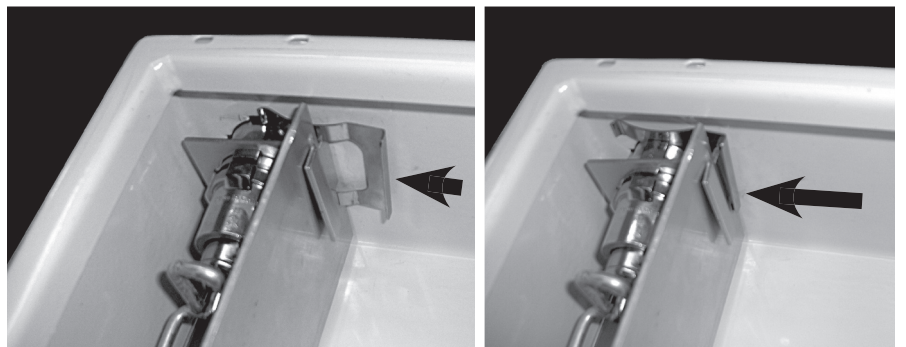

Figure 9. Insert original cover and screw as shown.



INSTALLATION INSTRUCTIONS CROSS BOX, LO-SIDE BOX AND SUPER-LO BOX

Figure 10. Remove screw and cover (save cover, it will be reused).

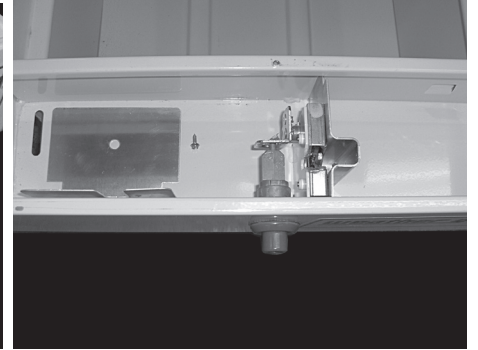
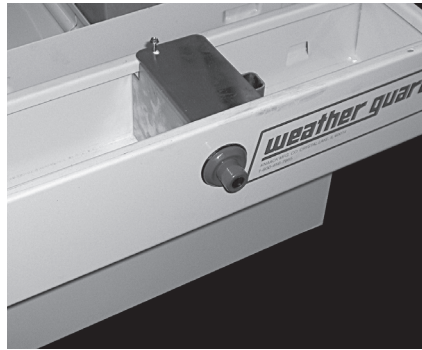

Figure 11. Remove lock clip and lock.

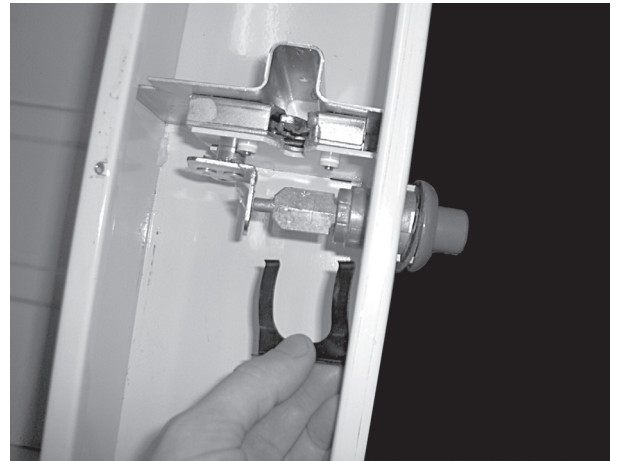

Figure 12. Wipe area with clean rag (metal surface must be free from dirt and oil).



Figure 13. Wipe area with alcohol wipe provided and let dry.



Figure 14. Peel adhesive backing from Cross Box and Lo-Side reinforcing plate and place as shown against lock and side of box (as shown by arrows); hold in place for one minute.

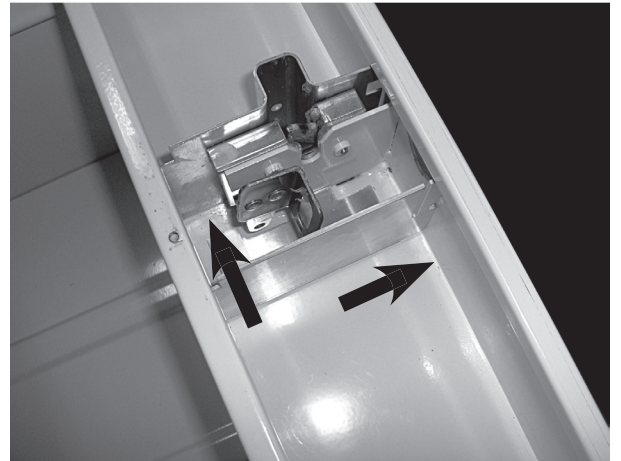

Figure 15. Insert anti-rotation tab as shown.

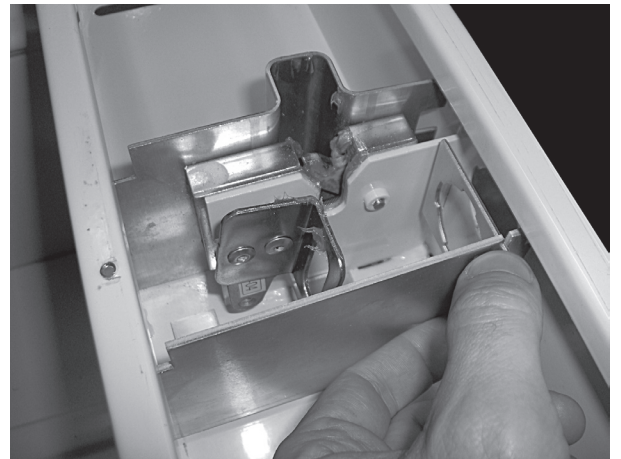

Figure 16. Insert new lock as shown.

Note: Make sure to install rubber gasket (included) between lock flange and box.



Figure 17. Insert lock clip as shown.

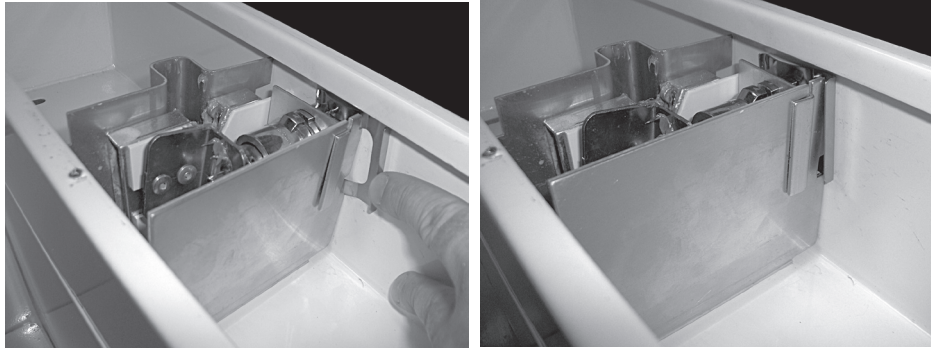
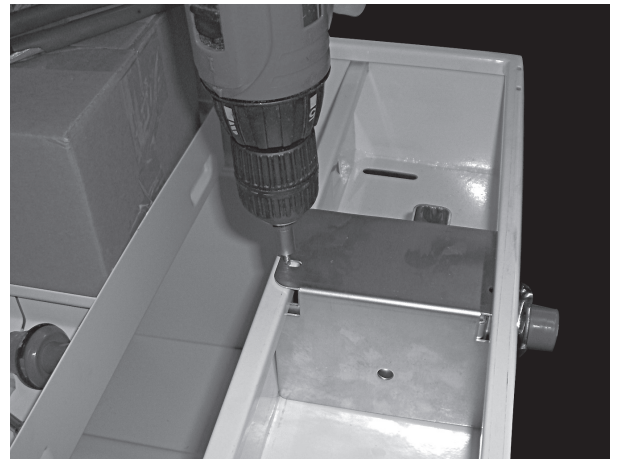

Figure 18. Install original cover with new screw
(use drill/driver with 1/4" hex).



Product fits based on vehicle design available at the revision date. Vehicle manufacturers may change specs after the revision date, so if you have a vehicle produced with a model year date after the revision date, please contact your distributor or Knaack LLC to verify fitting of product to vehicle.

WEATHER GUARD Products are protected by one or more of the following patents: U.S. 5145087, 5308126, 4509787, 4573731, 4618083, D-346355, D-346994, D-353574; Canada 1218968, 1224230, 1235100 and; U.K. 2233036. Other patents pending.

Knaack LLC
ATTN: Warranty Claims
420 E. Terra Cotta Avenue
Crystal Lake, IL 60014

If you have any questions, please call toll free at 1-800-456-7865.
©2013 Knaack LLC

