

#### LIMITED WARRANTY - UTILITY PUMPS:

Manufacturer warrants the products specified in this warranty to be free from defects in material or workmanship for one (1) years from date of purchase. During the time period and subject to the terms and conditions, the manufacturer will repair or replace to the original user or consumer any portion of this product which proves to be defective due to materials or workmanship. At all times the manufacturer shall have and possess the sole right and option to determine whether to repair or replace defective equipment, parts, or components. The manufacturer has the option to inspect any product returned under warranty to confirm that the warranty applies before repair or replacement under warranty is approved. This warranty sets forth the manufacturer's sole obligation and purchaser's exclusive remedy for defective product. Return defective product to the place of purchase for warranty consideration.

#### WARRANTY PERIOD - PRODUCTS:

If, within the duration of product use by the original user, this product proves to be defective due to materials or workmanship, the product shall be repaired or replaced at the manufacturer's option, subject to the terms and conditions set forth in this warranty statement. Proof of purchase is required for warranty consideration. In the absence of suitable proof of the purchase date, the effective period of this warranty is 12 months from the product's date of manufacture.

#### LABOR, ETC. COSTS:

The manufacturer shall IN NO EVENT be responsible or liable for the cost of field labor or other charges incurred by any customer in removing and/or affixing any product, part, or component thereof.

#### PRODUCT IMPROVEMENTS:

The manufacturer reserves the right to change or improve its products or any portions thereof without being obligated to provide such a change or improvement for units sold and/or shipped prior to such change or improvement.

#### GENERAL TERMS AND CONDITIONS:

This warranty shall not apply to damage due to acts of God, normal wear and tear, normal maintenance services and the parts used in connection with such service, lightning or conditions beyond the control of the manufacturer, nor shall it apply to products which, in the sole judgment of the manufacturer, have been subject to negligence, abuse, accident, misapplication, tampering, alteration; nor due to improper installation, operation, maintenance or storage; nor to excess of recommended maximums as set forth in the instructions. Warranty will be VOID if any of the following conditions are found:

1. Product is used for purposes other than those for which it was designed and manufactured
2. Product not installed in accordance with applicable codes, ordinances, and good trade practices
3. Product connected to voltage other than indicated on nameplate or labels
4. Pump exposed to but not limited to the following: sand, gravel, cement, grease, plaster, mud, tar, oil, gasoline, solvents or other abrasive or corrosive substances
5. Pump has been used for pumping liquids above 120°F
6. Pump allowed to operate dry (liquid supply cut off)

#### DISCLAIMER:

Any oral statements about the product made by the seller, the manufacturer, the representatives, or any other parties do not constitute warranties, shall not be relied upon by the user, and are not part of the contract for sale. Seller's and the manufacturers only obligation, and buyer's only remedy, shall be the replacement and/or repair by the manufacturer of the product as described above. NEITHER SELLER NOR THE MANUFACTURER SHALL BE LIABLE FOR ANY INJURY, LOSS OR DAMAGE, DIRECT, INCIDENTAL OR CONSEQUENTIAL (INCLUDING, BUT NOT LIMITED TO, INCIDENTAL OR CONSEQUENTIAL DAMAGES FOR LOST PROFITS, LOST SALES, INJURY TO PERSON OR PROPERTY, OR ANY OTHER INCIDENTAL OR CONSEQUENTIAL LOSS), ARISING OUT OF THE USE OR THE INABILITY TO USE THE PRODUCT, AND THE USER AGREES THAT NO OTHER REMEDY SHALL BE AVAILABLE TO IT. Before using, the user shall determine the suitability of the product for his/her intended use, and user assumes all risk and liability whatsoever in connection therewith.

THE WARRANTY AND REMEDY DESCRIBED IN THIS LIMITED WARRANTY IS AN EXCLUSIVE WARRANTY AND REMEDY AND IS IN LIEU OF ANY OTHER WARRANTY OR REMEDY, EXPRESSED OR IMPLIED, WHICH OTHER WARRANTIES AND REMEDIES ARE HEREBY EXPRESSLY EXCLUDED, INCLUDING BUT NOT LIMITED TO ANY IMPLIED WARRANTY OF MERCHANTABILITY OR FITNESS FOR A PARTICULAR PURPOSE, TO THE EXTENT EITHER APPLIES TO A PRODUCT SHALL BE LIMITED IN DURATION TO THE PERIODS OF THE EXPRESSED WARRANTIES GIVEN ABOVE.

Some states and countries do not allow the exclusion or limitations on how long an implied warranty lasts or the exclusion or limitation of incidental or consequential damages, so the above exclusion or limitations may not apply to you. This warranty gives you specific legal rights, and you may also have other rights which vary from state to state.



# OWNER'S MANUAL

## INSTALLATION AND OPERATION INSTRUCTIONS FOR SUBMERSIBLE UTILITY PUMP Model: 91359

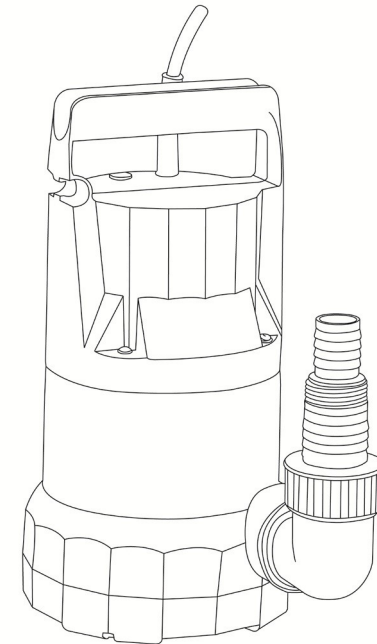



## Safety Guidelines

Carefully read, understand and follow all safety instructions in this manual.

 This is the safety alert symbol. When you see this symbol, look for one of the following signal words.

 **DANGER** Indicates a hazardous situation which, if not avoided, will result in death or serious injury.

 **CAUTION** Indicates a hazardous situation which, if not avoided, could result in death or serious injury.

 **WARNING** Indicates a hazardous situation which, if not avoided, could result in minor or moderate injury.

## Safety Information

Read these warnings carefully. Know the application and limitations of this pump. Failure to follow these warnings could result in serious bodily injury and/or property damage.

 **DANGER** RISK OF ELECTRICAL SHOCK. Disconnect and lockout power supply before removing old pump or installing or servicing this pump.

 **DANGER** RISK OF ELECTRICAL SHOCK. This pump is supplied with a grounding conductor and grounding type attachment plug. To reduce the risk of electric shock, be certain that it is connected only to a properly grounded, grounding type receptacle. For added safety, it is highly recommended to connect this pump to a GFCI (Ground Fault Circuit Interrupter) outlet. Connect only to a receptacle that is adequately rated for the voltage and amperage of this pump

 **WARNING** The installation of this pump must be in accordance with the National Electric Code (NEC), Uniform Plumbing Code (UPC), International Plumbing Code (IPC) as well as all applicable local codes and ordinances.

 **CAUTION** Do not install this pump in any location classified as hazardous by the National Electrical Code, ANSI/NFPA70.

 **CAUTION** Do not use this pump to pump flammable or explosive fluids such as gasoline, kerosene, etc. Do not use this pump in flammable or explosive environments. Use only with liquids compatible with pump component materials.

 **WARNING** RISK OF ELECTRICAL SHOCK. This pump has not been investigated for use in swimming pool or marine areas.

 **WARNING** RISK OF ELECTRICAL SHOCK. **DO NOT** use the power cord to remove or lower the pump into the basin. The cord may pull apart exposing bare wires which could cause a fire or electrical shock. Use the handle supplied with the pump for installing and removing the pump from the basin.

 **WARNING** Do not run the pump dry. This pump relies on water for cooling. Running the pump dry can cause the pump to overheat and the possibility of burns to anyone that handles the pump. Running the pump dry will void the warranty.

 **WARNING** Don't expose pump to freezing temperatures. Discharge lines exposed to freezing temperatures should be positioned with a downward slope to prevent freezing.

## Troubleshooting

PROBLEM	POSSIBLE CAUSES	HOW TO CORRECT
The pump does not start or run	Pump is not plugged in, switch or breaker is off	Plug pump in or turn on switch/breaker
	Check for blown fuses or tripped circuit breakers or tripped GFCI outlets	Replace fuse, reset breaker, reset GFCI outlet
	Motor thermal protector tripped	Allow pump to cool. Pump will automatically reset
The pump runs but moves little or no water	Clogged intake screen	Clean or replace screen
	Clogged discharge hose/pipe	Remove clog
	Frozen discharge hose/pipe	Allow hose/pipe to thaw
	Pump is air locked	Clean out airlock hole with a paper clip or pipe cleaner
	Low line voltage	Check wire size and increase if necessary
	Worn, damaged or clogged pump parts	Inspect for wear, damage or clog, clean or replace if necessary
Discharge head exceeds pump capacity	If pumping height is over 25' (7.6 m), the pump will not move water. See performance chart	

## Parts

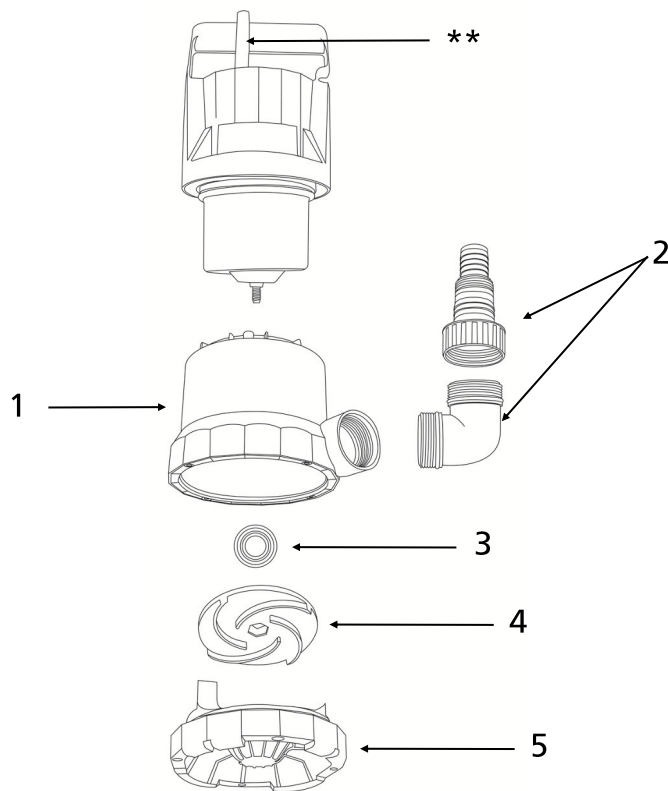

## Safety Information (continued)

**⚠ WARNING** Do not use this pump for potable/drinking water. Use only in applications for which the pump is designed for.

**⚠ WARNING** According to the state of California (Prop 65), this product contains chemicals known to the state of California to cause cancer and birth defects or other reproductive harm.

**⚠ WARNING** DO NOT UNDER ANY CIRCUMSTANCES REMOVE THE GROUND PIN. The 3-prong plug must be inserted into a mating 3-prong grounded receptacle. If the installation does not have such a receptacle, it must be changed to the proper type, wired and grounded in accordance with the National Electrical Code and all applicable local codes and ordinances.

**⚠ WARNING** All wiring must be performed by a qualified electrician.

**⚠ WARNING** Keep hands clear of suction & discharge openings. To prevent injury, never insert fingers into pump while it is plugged in.

**⚠ CAUTION** Do not handle this pump with wet hands or while standing on wet or damp surfaces or in water.

**⚠ WARNING** If a flexible discharge hose is used, make sure the pump is secured in the basin to prevent movement. Failure to secure the pump could result in flooding from switch malfunction.

**⚠ CAUTION** This pump motor is equipped with an automatic resetting thermal protector and may restart unexpectedly.

## Description

This submersible pump is designed to be used in pond, fountain or waterfall applications. It can also be used as a utility pump for water transfer/removal. The oil free motor is safe for fish and plants. It comes equipped with a 3-prong grounding type power cord and hose/pipe adapter.

## Specifications

Model: 91359	
HP	1/3
Volts	120 V AC
Amps	3.8 A
Hz	60 Hz
Phase	1
Motor Duty	Continuous*
Circuit Requirements	15 A minimum
Discharge Size	1-1/2" FNPT (1-1/2" MNPT, 1-1/4" Hose Barb, 1" MNPT, 1" Hose Barb using included adapters)
Max. Solids Handling	3/16" (0.5 cm) Spherical
Max. Liquid Temperature	120° F (49° C)
Cord Length	25' (7.6 m)
Pump Construction	Thermoplastic
Impeller	Open type, thermoplastic
Shaft Seal	Nitrile

\*For continuous operation, the water depth must be at least 6" (15 cm) to prevent the motor from overheating.

Ref#	Description
1	Pump Base (Volute)
2	Hose / Pipe Adapter
3	Shaft Seal
4	Impeller
5	Pump Screen

\*If motor fails, replace entire pump

\*\*The power cord and motor are not replaceable

Toll-free Helpline: 1-800-495-9278

## Standard Operation

**⚠️ WARNING** Risk of electric shock. Always disconnect the power source before attempting to install, service or perform maintenance on the pump. Failure to do so may result in fatal electrical shock.

1. The water level must be approximately 1" (25 mm) deep for the pump to operate.
2. Plug the power cord into a grounded 120 V AC outlet. The pump will start to operate as soon as the cord is plugged in.
3. The pump will lower the water level down to approximately 3/4" (19 mm) of the surface. The pump should be turned off once the water reaches this level.
4. Do not let the pump run dry. The pump depends on water for cooling and lubrication. Operating the pump without water may cause the motor to overheat or cause damage to internal parts. It may also shorten the life of your pump.
5. Your pump motor is thermally protected. It is not recommended for pumping liquids over 120° F (49° C). The thermal overload protector will automatically shut down the pump in an overheat situation. The pump will reset itself once it cools down. This overload is designed as a safety device and it will fail after repeated use. Normal operation is for fluids between 32° F and 120° F (0° C to 49° C).

## Optional Pond/Waterfall/Fountain Installation

### Pond/Waterfall/Fountain Installation

1. Install the pump on a hard level surface in the water. If necessary, place bricks or patio blocks under the pump to raise it off the bottom. Do not place the pump directly in mud, sand or silt or on rocky surfaces as these materials can clog or cause damage to the pump. Do not suspend the pump by the power cord or by the discharge pipe.
2. Connect outlet pipe or hose to the pump. See Figures 1 & 2 on page 4 for typical installations. This pump will accommodate 1-1/2" or 1" pipe as well as 1-1/4" or 1" hose. Choose the best size hose or pipe for your application.
3. If you are using a fountain head (sold separately) on the pump, use a valve to adjust the flow and spray height. Do not restrict the pump suction to adjust the flow. Restricting the suction will starve the pump of water and can damage the pump or cause it to overheat.

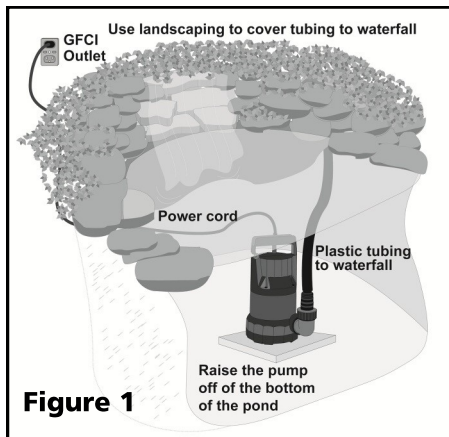

Figure 1

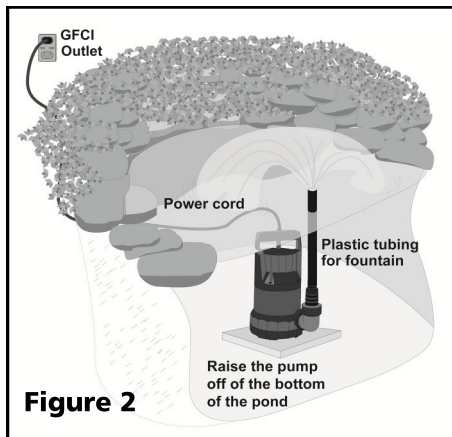

Figure 2

## Maintenance

**⚠️ WARNING** Risk of electric shock. Always disconnect the power supply before attempting to install, service or perform maintenance on the pump.

1. The pump motor is hermetically sealed in the housing and does not require any service. Disassembly of the motor housing or modification of the power cord voids the warranty.
2. Periodically check the removable intake screen for obstructions. Clean if necessary.
3. Inspect the impeller for signs of wear and obstructions.
4. Inspect the power cord for signs of damage or wear. Do not operate the pump if the cord is damaged or worn.

## Performances

Height and/or piping restriction will reduce the pump output performance. It is recommended to use the same size pipe as the pump discharge or larger for optimum performance. **NOTE:** The performances listed below are derived from using 1-1/2" pipe. Using smaller diameter pipe or hose will result in decreased flow.

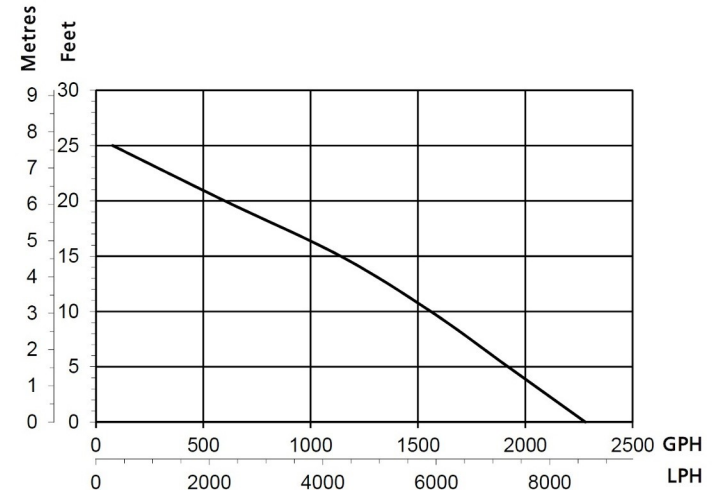

Discharge Height	0' (0 m)	5' (1.5 m)	10' (3 m)	15' (4.6 m)	20' (6 m)	25' (7.6 m)
Gallons Per Minute	38	32	26	19	10	1.3
Gallons Per Hour	2280	1920	1560	1140	600	78