

Operator's manual

**Vibratory plate**

**DPU**  
**80, 90, 110**



Model

DPU

Document

5100008833

Issue

06.2016

Version

06

Language

en

Copyright © 2016 Wacker Neuson Produktion GmbH & Co. KG

Printed in Germany

All rights are reserved, in particular the world-wide applicable copyright, right of duplication and right of distribution.

This document may only be used by the recipient for the intended purpose. The document may not be reproduced entirely or partially, or translated into any other language.

Reproduction or translation, even extracts thereof, only with written approval of Wacker Neuson Produktion GmbH & Co. KG.

Any breach of the statutory provisions, in particular the protection of copyright, will lead to civil and criminal prosecution.

Wacker Neuson Produktion GmbH & Co. KG is constantly working on the improvement of its products as part of the technical further development. Therefore, we reserve the right to make changes to the illustrations and descriptions in this documentation without incurring any obligation to make changes to machines already delivered.

Errors excepted.

The machine on the cover may have special equipment (options).



#### **Manufacturer**

Wacker Neuson Produktion GmbH & Co. KG

Preussenstrasse 41

80809 Munich

[www.wackerneuson.com](http://www.wackerneuson.com)

Tel.: +49-(0)89-354 02-0

Fax: +49-(0)89-354 02-390

**Translation of the original operator's manual in German**

<b>1</b>	<b>Preface</b> .....	<b>5</b>
<b>2</b>	<b>Introduction</b> .....	<b>6</b>
	2.1 Using the manual.....	6
	2.2 Storage location of the manual.....	6
	2.3 Accident prevention regulations.....	6
	2.4 More information.....	6
	2.5 Target group .....	6
	2.6 Explanation of symbols.....	6
	2.7 Wacker Neuson Contact partner .....	7
	2.8 Disclaimer.....	7
	2.9 Product identification of the machine.....	7
<b>3</b>	<b>Security</b> .....	<b>8</b>
	3.1 Policy .....	8
	3.2 Areas of responsibility of the operator .....	8
	3.3 Operator responsibilities .....	9
	3.4 Personnel qualification.....	9
	3.5 General sources of danger .....	9
	3.6 General safety instructions .....	9
	3.7 Specific safety instructions – Vibratory plates .....	10
	3.8 Specific safety instructions – remote controlled vibratory plates .....	10
	3.9 General safety instructions - Combustion engines .....	11
	3.10 General safety instructions – fuel, lubricants and coolants.....	11
	3.11 General safety instructions – starter batteries .....	11
	3.12 Maintenance .....	11
	3.13 Personal Protective Equipment .....	12
	3.14 Safety devices .....	12
	3.15 Behavior in dangerous situations.....	13
<b>4</b>	<b>Safety and information labels</b> .....	<b>14</b>
	4.1 Safety and information labels on the remote control .....	15
<b>5</b>	<b>Setup and function</b> .....	<b>16</b>
	5.1 Standard package .....	16
	5.2 Application areas .....	16
	5.3 Short description.....	16
	5.4 Versions.....	18
<b>6</b>	<b>Components and operator's controls</b> .....	<b>19</b>
	6.1 Components .....	19
	6.2 Operator's controls .....	20
	6.3 Components and operator's controls – remote control unit.....	23
<b>7</b>	<b>Transport</b> .....	<b>25</b>
	7.1 Loading and transport.....	25
<b>8</b>	<b>Operation and use</b> .....	<b>27</b>
	8.1 Before commissioning .....	27
	8.2 Notes about operation .....	29
	8.3 Commissioning .....	30
	8.4 Operation.....	33
	8.5 Decommissioning .....	36
	8.6 Setting the transmission channel (remote control) .....	41
	8.7 Operating the diagnostic menu.....	41
	8.8 Operation of the configuration menu .....	42
<b>9</b>	<b>Maintenance</b> .....	<b>43</b>
	9.1 Maintenance schedule – One-time maintenance job.....	43

---

9.2	Maintenance schedule – daily maintenance jobs .....	44
9.3	Maintenance schedule – regular intervals .....	44
9.4	Maintenance jobs.....	45
<b>10</b>	<b>Troubleshooting .....</b>	<b>52</b>
10.1	Troubleshooting table – machine.....	52
10.2	Troubleshooting table – receiving units .....	53
10.3	Fault table - Center pole head control lamp.....	53
10.4	Troubleshooting chart – remote control .....	54
10.5	Troubleshooting table – display .....	55
10.6	Perform jump start with donor starter battery .....	59
<b>11</b>	<b>Disposal .....</b>	<b>61</b>
11.1	Disposal of batteries .....	61
<b>12</b>	<b>Accessories .....</b>	<b>62</b>
<b>13</b>	<b>Technical data .....</b>	<b>63</b>
13.1	DPU80 .....	63
13.2	DPU80r .....	64
13.3	DPU90 .....	65
13.4	DPU90r .....	66
13.5	DPU110 .....	67
13.6	DPU110r .....	68
13.7	Combustion engine.....	69
13.8	US combustion engine.....	70
<b>14</b>	<b>Emission control systems information and warranty .....</b>	<b>71</b>
	<b>EC declaration of conformity .....</b>	<b>72</b>
	<b>EC declaration of conformity .....</b>	<b>73</b>

## **1 Preface**

This operator's manual contains important information and procedures for the safe, proper and economic operation of this Wacker Neuson machine. Carefully reading, understanding and observing is an aid to avoiding hazards, repair costs and downtime, and therefore to increasing the availability and service life of the machine.

This operator's manual is not a manual for extensive maintenance or repair work. Such work should be carried out by Wacker Neuson service or by technically trained personnel. The Wacker Neuson machine should be operated and maintained in accordance with this operator's manual. An improper operation or improper maintenance can pose dangers. Therefore, the operator's manual should be constantly available at the location of the machine.

Defective machine parts must be exchanged immediately!

If you have any questions concerning the operation or maintenance, a Wacker Neuson contact person is always available.

## 2 Introduction

### 2.1 Using the manual

This manual is to be considered part of the machine and should be carefully stored during the entire service life of the machine. This manual shall be transferred to subsequent owners or users of the machine.

### 2.2 Storage location of the manual

This manual is part of the machine and must be kept in the immediate vicinity of the machine and made accessible to staff at all times.

If this manual is lost, or if a second copy is required, there are two options to obtain a replacement:

- Download from the Internet [www.wackerneuson.com](http://www.wackerneuson.com)
- Contact your Wacker Neuson contact partner.

### 2.3 Accident prevention regulations

In addition to the notes and safety instructions in this manual, the local accident prevention regulations as well as the national health and safety regulations apply.

### 2.4 More information

This manual applies to various machine types from one product series. For this reason, some figures may vary slightly in appearance from the machine purchased. Depending on the model, there may be descriptions of components that are not included in the standard package.

The information contained in this manual is based on machines manufactured up to the time of printing. Wacker Neuson reserves the right to change this information.

The manufacturer shall immediately include any modifications or additions in this manual.

### 2.5 Target group

Individuals working with this machine must be regularly trained on the dangers of handling the machine.

This operator's manual is intended for the following persons:

Operating personnel:

These individuals have been trained on the machine and informed about the possible dangers in the event of improper conduct.

Technically trained personnel:

These people have professional training as well as additional knowledge and experience. They are able to assess the tasks assigned to them and recognize possible dangers.

### 2.6 Explanation of symbols

This manual contains specially emphasized safety instructions in the following categories: **DANGER**, **WARNING**, **CAUTION** and **NOTICE**.

Before performing any work on or with this machine, the notes and safety instructions must be read and understood. All notes and safety instructions in this manual must be passed on to the maintenance, repair, and transport personnel.



#### **DANGER**

This combination of symbol and signal word indicates a hazardous situation that will lead to death or serious injury if it is not avoided.



#### **WARNING**

This combination of symbol and signal word indicates a hazardous situation that can lead to death or serious injury if it is not avoided.



#### **CAUTION**

This combination of symbol and signal word indicates a hazardous situation that can lead to minor injury or damage to the machine if it is not avoided.

---

**NOTICE**

Supplementary information.

---

**2.7 Wacker Neuson Contact partner**

Depending on the country, the Wacker Neuson contact partner is a Wacker Neuson service department, a Wacker Neuson affiliate, or a Wacker Neuson dealer.

On the Internet at [www.wackerneuson.com](http://www.wackerneuson.com).

The manufacturer's address can be found at the beginning of this manual.

**2.8 Disclaimer**

For the following violations, Wacker Neuson dismisses any liability for personal injury or material damage:

- Failure to follow this manual.
- Unintended use.
- Deployment of untrained personnel.
- Using non-approved spare parts and accessories.
- Improper handling.
- Structural modifications of any kind.
- Failure to observe the "General Terms and Conditions" (GT&Cs).

**2.9 Product identification of the machine****Data of the nameplate**

The nameplate contains information that uniquely identifies this machine. This information is required for ordering spare parts and when inquiring about technical issues.

- Enter information about the machine in the following table:

Designation	Your information
Group and model	
Year of manufacture	
Serial number	
Version no.	
Item number	

## 3 Security

---

### NOTICE

Read and comply with all notes and safety instructions in this manual. Failure to comply with these instructions can cause electric shock, fire and/or serious injuries as well as damage to the machine and/or damage to other objects. Keep safety instructions and notes for the future.

---

### 3.1 Policy

#### In keeping with the latest technological developments

The machine has been built in keeping with the latest technological developments and the recognized technical safety rules. Nevertheless, improper use can result in hazards to life and limb of the user or third parties as well as damage to the equipment and other material assets.

#### Proper use

The machine may only be used for the following purposes:

- Soil compaction.
- Asphalt compaction.
- Vibration of sett paving (paving stones).

#### The machine may not be used for the following purposes:

- Compaction of very cohesive soils.
- Compaction of frozen soils.
- Compaction of hard, non-compressible soils.
- Compaction of non-load-bearing soils.

Use in accordance with the intended purpose also includes the observation of all safety instructions in this manual as well as complying with the prescribed care and maintenance instructions.

Any use that exceeds or is not in accordance with the intended purpose is considered improper. The manufacturer's liability and warranty are canceled for any damage resulting from improper use. The risk lies entirely with the operator.

#### Structural changes

Structural modifications may not be undertaken without the written permission of the manufacturer. Unapproved structural changes may result in risks to the operator and/or third parties as well as damage to the machine.

In the case of unauthorized structural changes, the liability and warranty of the manufacturer are no longer applicable.

#### The following cases are considered structural changes:

- Opening the machine and the permanent removal of components.
- Installing spare parts that do not originate from Wacker Neuson or are not comparable in the design system and quality of the original parts.
- Attaching any accessories that do not originate from Wacker Neuson .

Spare parts or accessories that originate from Wacker Neuson can be safely mounted. They can be found on the Internet under [www.wackerneuson.com](http://www.wackerneuson.com).

### 3.2 Areas of responsibility of the operator

The operator is the individual who personally operates this machine for industrial or commercial purposes or who entrusts a third party with the use. The operator bears legal responsibility for his/her protection as well as that of third parties.

The user must make the operator's manual available to the operator and ensure that this has been read and understood.

The manual must be kept next to the machine or place of use.

The operator must hand over the manual to subsequent operators or owners of the machine.

The country-specific regulations, standards, and guidelines on accident prevention and environmental protection must be observed. The operator's manual must be supplemented with additional instructions that take regulatory, national, or generally applicable safety standards into consideration.

### **3.3 Operator responsibilities**

- Know and implement the applicable industrial safety regulations.
- Use a risk assessment to identify the dangers that result from the working conditions at the site of application.
- Create operating instructions for the operation of this machine.
- Periodically check whether the user instructions correspond to the current state of regulations.
- Clearly regulate and specify responsibilities for operation, troubleshooting, maintenance, and cleaning.
- Regularly train employees and inform them about potential hazards.
- Provide employees with the necessary equipment.

### **3.4 Personnel qualification**

This machine may only be installed and operated by trained personnel.

Faulty operation, misuse or operation by untrained personnel can endanger health of the operator or third parties and lead to damage to or total loss of the machine.

**In addition, the operator should be:**

- physically and mentally fit.
- not under the influence of drugs, alcohol or medication that can impair responsiveness.
- familiar with the safety instructions in this manual.
- familiar with the intended use of this machine.
- the minimum age (18 years) to operate this machine.
- Be instructed in the independent operation of the machine.
- Be authorized to operate machines and systems independently according to the standards of safety engineering.

### **3.5 General sources of danger**

Residual dangers in particular are hazards when dealing with machines that, despite a safe design, cannot be eliminated.

These residual dangers are not obvious and may be the source of a possible injury or health hazard.

If unforeseeable residual dangers occur, the operation of the machine is to be stopped immediately and the competent supervisor is to be informed. This supervisor shall make the following decisions and initiate everything required to eliminate the occurring danger.

If necessary, the machine manufacturer is to be informed.

### **3.6 General safety instructions**

The safety instructions in this chapter include the "General Safety Instructions", which should be reported in the manual in accordance with the applicable standards. There may be information that is not relevant to this machine.

#### **3.6.1 Working area**

- Before starting work, familiarize yourself with the working environment e.g. load-bearing capacity of the floor or obstacles in the environment.
- Make working area safe for the public transport sector.
- Necessary fuse protection of walls and ceilings e.g. in trenches.
- Keep the working area tidy. Cluttered or dark working areas can lead to accidents.
- Using this machine in an explosive atmosphere is prohibited.
- When using this machine, children and unauthorized individuals must be kept away. Distraction can lead to loss of control of the machine.
- Always protect the machine against tilting, rolling, sliding, and crashing. Risk of injury!

#### **3.6.2 Service**

- The machine should only be maintained/repaired by technically trained personnel.
- Use only original spare parts and accessories. This ensures the operational safety of the machine.

#### **3.6.3 Personal safety**

- Working under the influence of drugs, alcohol, or drugs can lead to serious injuries.

- Protective equipment should be worn for all work. Appropriate personal protective equipment considerably reduces the risk of injury.
- Remove any tools before the machine is put into operation. Tools that are located on a rotating machine part can be ejected and cause serious injury.
- Always ensure good footing.
- In the case of extensive work with this machine, long-term vibration-induced damage cannot be ruled out. For exact values of vibration measurement, refer to the *Technical Data* section.
- Wear suitable clothing. Keep loose clothing, gloves, jewelry, and long hair away from moving/rotating machine parts. Danger of being pulled!
- Ensure that no other individuals are in the danger zone!

### 3.6.4 Handling and use

- Handle machines with care. Do not operate machines with defective components or operator's controls. Immediately replace defective components or operator's controls. Machines with defective components or operator's controls carry a high risk of injury!
- The operator's controls of the machine shall not be improperly locked, manipulated, or changed.
- The machine, accessories, and tools should be used in accordance with these instructions.
- Store unused machines out of reach of children. The machine may only be operated by authorized personnel.
- After operation, store the cooled-down machine in a locked, clean, frost-protected, and dry location that is inaccessible to children and other unauthorized individuals.

## 3.7 Specific safety instructions – Vibratory plates

### 3.7.1 External influences

**In the case of the following external influences, the vibratory plate may not be operated:**

- In heavy rain on sloped surfaces. Risk of slipping!
- Oil field environments – methane leaks from bottom. Explosion hazard!
- In dry, flammable vegetation. Fire hazard!
- In potentially explosive areas. Explosion hazard!

### 3.7.2 Operational safety

- When operating the machine, make sure that no gas, water, or electric lines are damaged.
- The machine must not be operated in tunnels or enclosed spaces.
- Pay maximum attention near drops or slopes. Risk of crashing!
- The operator must not leave the machine while it is in operation.
- Do not leave the machine unattended. Risk of injury!
- Protect the machine from unauthorized operation. When not in use, lock the rear protective hood with a padlock.
- Delimit spacious workspace and restrict access to unauthorized individuals. Risk of injury!
- The operator of the machine must ensure that all individuals keep a minimum distance of 2 m from the machine while it is in operation.
- Do not use any starting aid sprays. These can cause misfires as well as engine damage. Fire hazard!
- When operating the machine on sloped surfaces, always approach slopes from below and always stay above the machine on a slope. The machine could slip or tip over.
- Do not exceed max. allowable slanting position of the machine – possible failure of the engine lubrication, see chapter *Technical Data*.
- Only Wacker Neuson starter batteries. These are vibration proof and therefore suitable for the high vibration exposure.

### 3.7.3 Minimum safety distances

Compaction work near buildings can cause damage to buildings. Therefore, all potential effects and vibrations on surrounding buildings must be checked in advance.

The relevant rules and regulations for measuring, evaluating and reducing vibration emissions, especially the DIN 4150-3, must be considered.

Wacker Neuson assumes no liability for any damage to buildings.

## 3.8 Specific safety instructions – remote controlled vibratory plates

- Always keep remote control and receiving units of the machine clean and free from dry, oil, and grease.



- Remote control and receiving units must not be taped over or covered.
- During operation, the remote control should always be aimed directly at the machine. A clear line of sight must be maintained – infrared signals can be reflected.
- The operator should remain 5 meters behind the machine in accordance with the intended purpose.

### **3.9 General safety instructions - Combustion engines**

**The following notes must be observed:**

- Before starting work, check the engine to ensure there are no leaks and/or cracks in the fuel lines, tank, and fuel cap.
- Do not operate a defective engine. Replace damaged parts immediately.
- The pre-set engine speed may not be adjusted. This could lead to engine damage.
- Make sure that the exhaust system of the engine is free of debris. Fire hazard!
- Switch off before refueling the engine.
- Use the correct fuel type. The fuel may not be mixed with other liquids.
- Use clean filling aids for refueling. Do not spill fuel. Immediately wipe up any spilled fuel.
- The engine may not be started near spilled fuel. Explosion hazard!
- When operating in partially enclosed spaces, adequate ventilation must be ensured. Do not inhale exhaust fumes. Risk of poisoning!
- The engine surface and exhaust system can quickly become extremely hot. Risk of burns!
- Do not open the radiator cap when the engine is hot – Use caution: hot coolant!

---

#### **NOTICE**

This machine is outfitted with an EPA-certified engine.  
Adjusting the revolutions per minute (RPM) impacts the EPA-certification and the emissions. Settings for this engine may only be changed by a professional.  
For more information, contact the manufacturer or your Wacker Neuson contact partner.

---

### **3.10 General safety instructions – fuel, lubricants and coolants**

**The following notes must be observed:**

- Always wear safety glasses and protective gloves when handling fuel, lubricants, and coolants. If hydraulic oil, fuel, oil, or coolant gets into your eyes, consult a physician immediately.
- Avoid direct skin contact with fuel, lubricants and coolants. Immediately rinse skin with soap and water.
- Do not eat or drink while working with fuel, lubricants and coolants
- Hydraulic oil or fuel contaminated by dirt or water can cause premature wear or failure of the machine.
- Dispose of spilled fuel, lubricants and coolants according to the applicable provisions for environmental protection.
- If fuel, lubricants and coolants escape from the machine, do not operate the machine any longer and have it repaired immediately by the Wacker Neuson contact partner.

### **3.11 General safety instructions – starter batteries**

**The following notes must be observed:**

- When disconnecting the starter battery, always disconnect the negative terminal first!
- When connecting the starter battery, always connect the positive terminal first! Fasten battery terminal cover!
- Flames, sparks, and smoking are prohibited when handling starter batteries.
- Starter batteries contain corrosive acid. Wear acid-proof protective gloves and safety glasses when handling starter batteries.
- Prevent incorrect connection of the starter battery or bridging of the terminals with tools. Risk of short circuit!

### **3.12 Maintenance**

**The following notes must be observed:**

- This machine may not be maintained, repaired, adjusted or cleaned while switched on. Disconnect the starter battery when working on the electrical system!
- Adhere to maintenance intervals.

- After each maintenance or repair, the safety devices on this machine must be reattached.
- Observe the maintenance schedule. Identified work must be taken over by the service department of the Wacker Neuson contact partner.
- Immediately replace worn or damaged machine parts. Only use spare parts from Wacker Neuson.
- Keep the machine clean.
- Missing, damaged, or illegible safety warning labels should be replaced immediately. Safety stickers contain important information for the protection of the operator.
- Maintenance jobs must be carried out in clean and dry environment (e.g. in a workshop).



### 3.13 Personal Protective Equipment

---

**NOTICE**

To prevent personal injury when handling this machine, personal protective equipment must be worn when working on or around this machine.

---

Pictogram	Significance	Description
	Wear safety shoes!	Safety shoes provide protection from bruises, falling objects, and slipping.
	Wear protective gloves!	Protective gloves provide protection from abrasion, cuts, punctures, and hot surfaces.
	Wear ear protection!	Ear protection provides protection from permanent hearing impairment.

---

**NOTICE**

With this machine, the permissible, country-specific noise limit (personal rating level) may be exceeded. Therefore, ear protection must be worn. For exact values regarding noise emissions, refer to *Technical Data* section.

When wearing ear protection, remain alert because your ability to hear noises such as screams or signal tones is restricted.

Wacker Neuson recommends always wearing ear protection.

---

### 3.14 Safety devices

Safety devices protect the user of this machine from being exposed to existing hazards. These are barriers (separating protective devices) or other technical measures. This prevents the user from being exposed to a danger. The source of danger will be eliminated in certain situations or the danger will be reduced.

This machine has the following safety equipment:

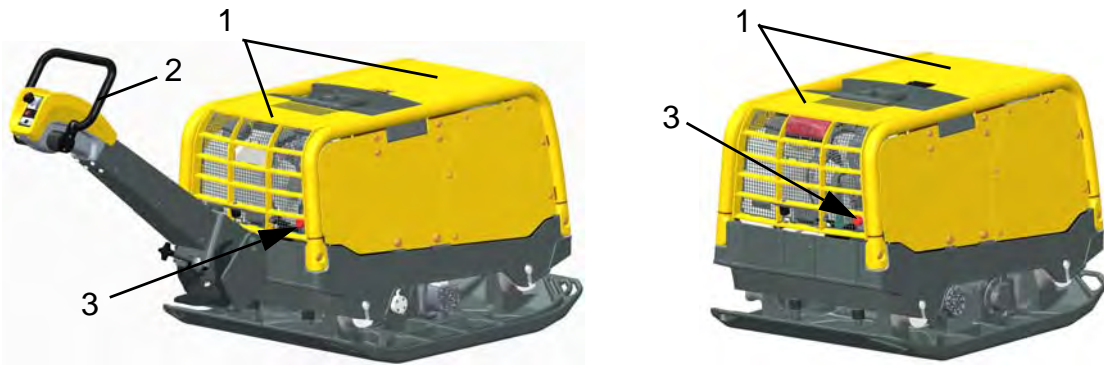

Item	Description	Item	Description
1	Protective frame / protective hoods	3	Emergency stop switch
2	Automatic central position of control handle		

#### NOTICE

Always tighten loosened screwed connections with the prescribed torque setting.

#### Protective frame / protective hoods

The protective frame with the protective hoods protects the operator in particular from hot engine parts and noise.

#### Emergency stop switch

The emergency stop switch is used solely to switch off the machine in the case of danger. Activating the emergency stop switch results in the machine immediately switching off. Operation can only be resumed after unlocking the emergency stop switch.

#### Automatic central position of control handle

If the control handle is released in full load, it automatically returns to the central position and the machine enters stand vibration.

### 3.14.1 Safety shutdown – Remote-controlled machinery

**The machine is operated via an infra-red remote control. For safety reasons, it switches off vibration and movement in the following situations:**

- When the operator enters the proximity area (approx. 1–2 meters from a receiving unit).
- When the operator leaves the receiving area (a maximum of 20 meters from the machine).
- Interruption of the clear line of sight between the remote control and receiving units of the machine.
- Power failure of remote control and/or machine.

### 3.15 Behavior in dangerous situations

#### Preventive measures:

- Always be prepared for accidents.
- Keep first aid equipment on hand.
- Make sure that all employees are familiar with accident reporting, first aid, and rescue facilities.
- Keep access routes clear for emergency vehicles.
- Make sure that employees receive first aid training.

#### Measures in the case of an emergency:

- Immediately take the machine out of operation.
- Remove injured and other people from the danger zone.
- Initiate first aid measures.
- Alert rescuers.
- Keep access routes clear for emergency vehicles.
- Inform the person responsible at the site of application.

## 4 Safety and information labels



### WARNING

Illegible symbols

Over time, labels and signs on the machines can become dirty or otherwise unrecognizable.



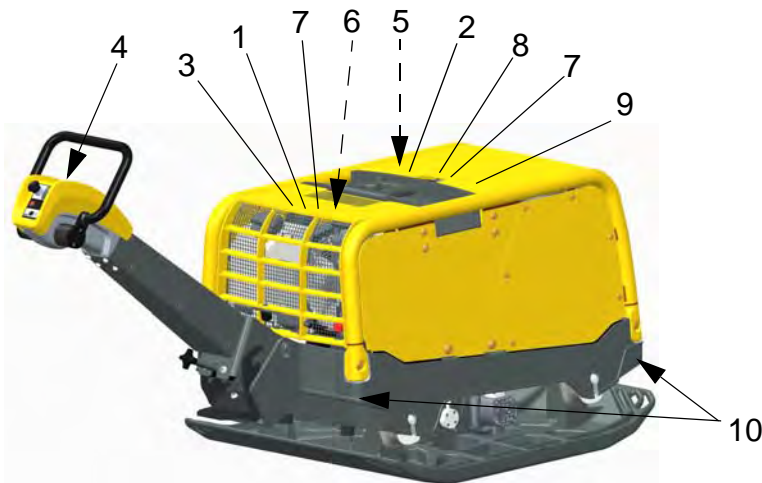

- Keep all safety, warning, and operating instructions on the machine in a legible condition.
- Replace damaged labels and signs immediately.

The following labels are found on and in the machines:



Item	Label	Description
1		Use personal protection equipment in order to prevent injuries and health hazards. <ul style="list-style-type: none"> <li>■ Ear protection.</li> <li>■ Read operator's manual.</li> </ul>
2		Falling machines can cause serious injury. <ul style="list-style-type: none"> <li>■ Only lift machine at the central lifting point with certified lifting gear and tackle (safety load hook).</li> <li>■ Do not lift the machine on the central lifting point with an excavator bucket.</li> <li>■ Do not lift the machine on the central lifting point with a forklift.</li> </ul>
3		Guaranteed sound power level.
4	Center pole machines 	Falling machines can cause serious injury. <ul style="list-style-type: none"> <li>■ Do not lift the machine with the control handle or center pole.</li> </ul>
5		The coolant is under pressure. Hot coolant can spurt out and cause injury from scalding. <ul style="list-style-type: none"> <li>■ Only open the cover of the radiator after the engine has cooled down.</li> </ul>
6	Remote controlled machines 	<ul style="list-style-type: none"> <li>■ Label identifies the remote control in the bracket.</li> <li>■ Label identifies the connection of the charging cable for charging.</li> </ul>



Item	Label	Description
7	US Machines 	Warning.
8		Closing the protective hood can lead to crushing wounds. <ul style="list-style-type: none"> <li>When closing the protective hood, do not grab between the machine and the protective hood.</li> </ul>
9		Warning against hot surface.
10		Tie-down lugs.

### 4.1 Safety and information labels on the remote control

The following labels are found on the remote control:

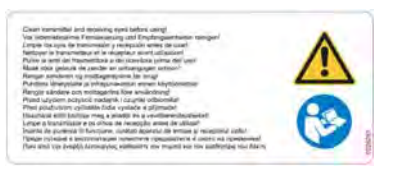
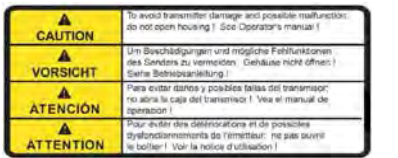

Item	Label	Description
1	US Machines 	To prevent interference of the infrared transmission and possible machine malfunction, do not attach to housing. Clean before transmitter and receiver eye before commissioning!
		Clean remote control and receiving unit before commissioning!
2	US Machines 	To prevent damage and possible malfunction of the transmitter unit, do not open housing! See operator's manual!

## 5 Setup and function

### 5.1 Standard package

The machine is delivered fully assembled and is ready for operation out of the box.

**The standard package includes:**

- Vibratory plate
- Remote control (optional)
- Operator's manual
- Manual for machine configuration (includes PIN data of the machine)

### 5.2 Application areas

The vibratory plate is used for compacting soil. It is used in gardening and landscaping as well as civil engineering, road construction, and paving.

### 5.3 Short description

The water-cooled drive motor in the upper mass hydraulically powers the eccentric weight of the base plate.

The exciter is designed as a centrally mounted exciter. This principle enables the modification of the direction of oscillation (by adjusting the eccentric weights) and thus the movement of the machine (forwards, in reverse or on-the-spot vibration).

For the exciter of the remote controlled machine, eccentric weights can be individually adjusted in order to allow steering movements. In addition, spot vibration can be adjusted.

The radiator reduces the temperature of the engine coolant as well as that of the hydraulic oil.

The intake air is aspirated in the cold area between the radiator and the rear protective hood and purified via an air cleaner equipped with a pre-cleaner.

The muffler discharges exhaust fumes from the front.

To start the drive motor automatically, the glow plugs are preheated. The speed of the drive motor is controlled via a lifting magnet. The machine is switched off via an electrically controlled solenoid valve on the fuel filter.

The electrical control unit is located in the electrical box.

The operator's controls are located at the electrical box and at the center pole head.

The maintenance-free starter battery is located below the bracket for the remote control.

The machine is controlled with the center pole. For the remote controlled machine, it is controlled exclusively via the remote control.

#### 5.3.1 Remote-control vibratory plate

The machine is controlled exclusively by the remote control.

Within the receiving area, the commands of the remote control are transmitted to the machine via infrared signal.

For trouble-free transmission of the infrared signal, the remote control must always be aimed directly at one of the receiving units of the machine.

**The following commands are possible with the remote control:**

- Start engine.
- Move machine with simultaneous vibration.
- Switch spot vibration on and off.
- Move machine slow or fast.
- Switch off engine.

**Infrared system**

If the remote control has been activated by pressing the ON/OFF switch, it permanently sends infrared signals to the respective receiving unit of the machine.

The receiving unit of the machine converts the infrared signal into an electrical signal. The control electronics process the electrical signal and control the machine in accordance with the control command.

In order for the machine to be able to execute the control commands, the remote control and machine must be set to the same transmission channel.

Each machine has its own address for the transmission channel. Upon delivery, the transmitter unit is set to the address of the machine and will only work with this machine. If the transmitter unit operates another machine, this can be adjusted, see *Setting the transmission channel (remote control)* chapter.

### Receiving area

Operation is only possible when the machine is within the receiving area. The receiving area is approximately 20 meters from a receiving unit of the machine.

Within the receiving area, there must always be a clear line of sight between the remote control and the machine. If there is no clear line of sight, the machine will cease all vibration and movement.

Outside of the receiving area, the machine will not receive the commands. The machine will stop vibrating and moving.

### Proximity area

If the machine comes within 1–2 meters (proximity area) of the operator, it will cease all vibration and movement. Once the operator leaves the proximity area, the machine is once again able to receive commands.

If the operator is laterally closer than 1–2 m from the machine or if the infrared signals of the remote control are transmitted via reflection, a stopping of the vibration and movement is not guaranteed.

If another person comes within 1–2 meters (proximity area) of the machine, the machine will not cease vibration and movement. The shutdown in the proximity area only works in conjunction with the remote control unit.

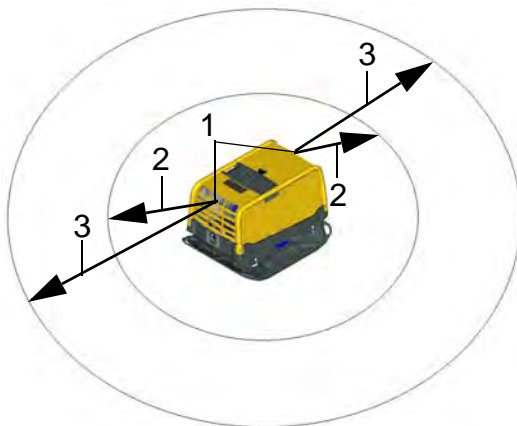

Item	Designation	Item	Designation
1	Receiver unit (front, rear)	3	Receiving area
2	Proximity area		

### 5.3.2 Diagnostic system

The diagnostic system of the machine consists of control electronics and sensors that monitor various components of the machine.

If the diagnostic system detects a fault or an error, this is signaled to the receiving unit by solid or flashing red lights. A fault indication with error code appears on the display.

Each error code stands for a specific fault. The diagnostic system can distinguish between approx. 30 error codes.

In case of serious faults, the error code is entered into the error memory, and the machine will automatically switch off the motor or deactivate itself.

### 5.3.3 Machine configuration system

In the machine configuration system, machine parameters can be changed by the user (e.g. switching an activation PIN on or off).

### 5.3.4 Machine protection – installation (optional)

The acceleration load of the upper mass is monitored via a sensor. When a threshold value corresponding to an operation of the vibratory plate on an extremely hard surface (concrete, asphalt) is exceeded, a warning is given to the operator that the vibrator plate is overloaded. This warning is that the control lamp on the center pole head or the receiving unit will flash red.

In addition, the machine will respond in one of the following ways (adjustable in the machine configuration):

- Only an entry in the error memory.
- Lowering the excitation speed.
- Shutdown of the machine with entry in the error memory.
- Switch-over to slow mode.

### 5.3.5 Compatec system (optional)

The Compatec system is integrated into the rear protective hood and is located within the operator's line-of-sight. The display, which consists of eight light-adjusting LEDs, displays the relative compaction progress while driving by successively lighting up. When the number of illuminated LEDs no longer increases, this means that no further compaction can be achieved with the machine. The operator can finish the work and avoid unnecessary passes.

The overload display indicates if the machine is being operated on too hard of a surface. The operator is notified of this through an alternating flashing of the LED's.

The Compatec system is suitable for all highly compactable and mixed (well graded) soils.

---

#### NOTICE

The Compatec system only supports soil compaction and does not replace the professional measuring of soil density by an expert.

---

## 5.4 Versions

This operator's manual covers the following models:

Versions	Description
r	Remote start
m	Machine protection – installation
c	Compatec system

## 6 Components and operator's controls

### 6.1 Components

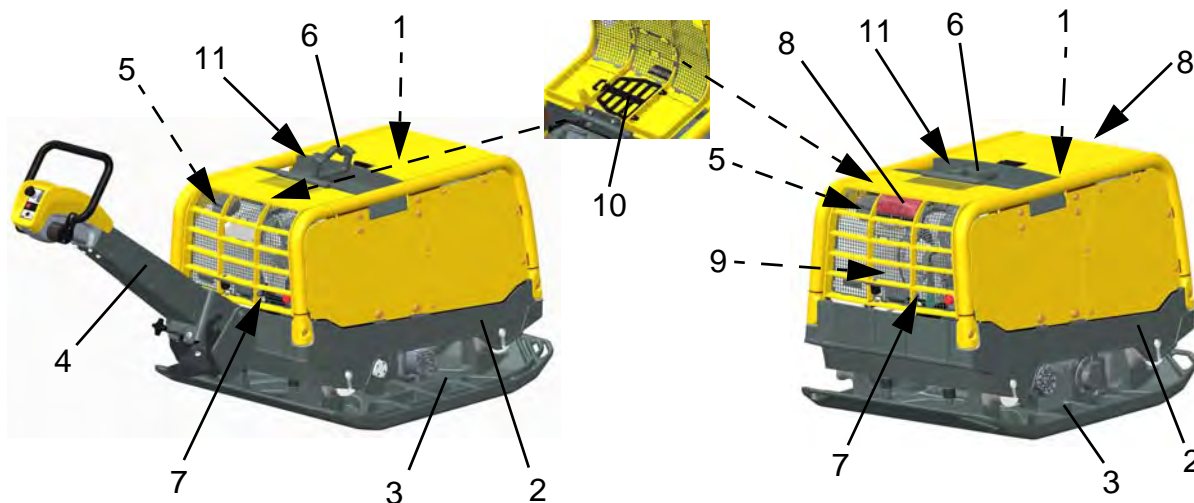

Item	Designation	Item	Designation
1	Drive motor	7	Eyelet for padlock
2	Upper mass	8	Receiving units
3	Base plate	9	Bracket for remote control and charging cable
4	Center pole	10	Bracket for operator's manual
5	Fuel tank	11	Nameplate
6	Central lifting point		

#### Center pole

The center pole can be adjusted to the optimum working height.

#### Central lifting point

The central lifting point is used to lift the machine. When the overall height is a deciding factor, the central lifting points can be folded.

#### Receiving units

On the remote controlled machine, there are two receiving units (front and rear) with integrated status display. Depending on the position of the operator, the front or rear receiving unit receives the commands of the remote controller via infrared signal.

The integrated status display uses lights and flashing signals to indicate the current operating status of the machine.

To better distinguish between the front and rear of the machine, the receiving units have different colors.

#### Eyelet for padlock

The rear protective hood features a lug for attaching a padlock. The machine is thus protected against unauthorized opening of the rear protective hood as well as unauthorized operation.

#### Bracket for remote control and charging cable

The bracket is used to store and charge the remote control unit as well as to protect it against damage and theft.

#### Bracket for operator's manual

The bracket is used to store the operator's manual.

## 6.2 Operator's controls

Always keep the display and operator's controls on the machine clean, dry, and free of oil and grease. Operator's controls such as the ON/OFF switch, and throttle control handles may not be locked, manipulated, or changed without permission.

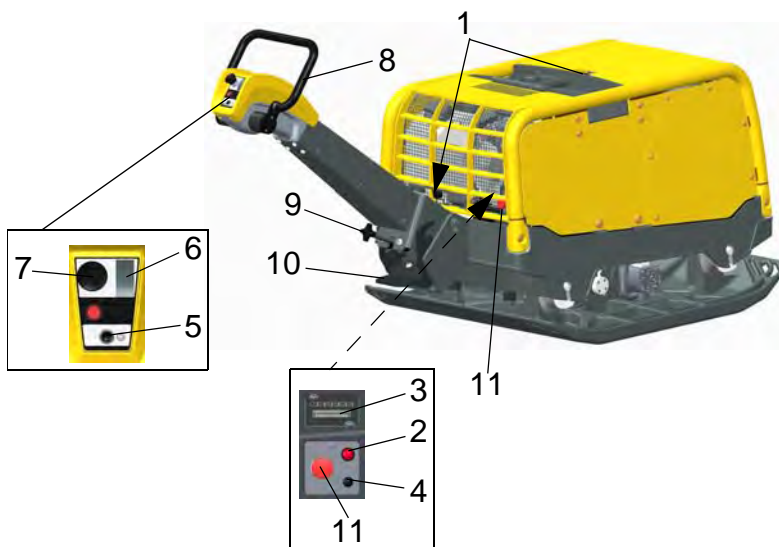

Item	Designation	Item	Designation
1	Hood opener	7	Vibratory rammer
2	ON/OFF switch (red)	8	Control handle
3	Display and control lamps (diagnostic and configuration menu)	9	Height adjustment mechanism of center pole
4	Adjusting key (black)	10	Footrest of center pole lock
5	Start button	11	Emergency stop switch
6	Slow/fast rocker switch		

### Control handle

The control handle is used to continuously regulate the speed and travel direction.

### Footrest of center pole lock

The footrest of the center pole lock is used to release the center pole from the transport position so that it can be returned to working position. The individually adjusted working height is maintained.

### Emergency stop switch

The emergency stop switch is used solely to switch off the machine in the case of danger. Activating the emergency stop switch results in the machine immediately switching off. Operation can only be resumed after unlocking the emergency stop switch.

### Height adjustment mechanism of center pole

The center pole height-adjustment mechanism allows for continuous height adjustment in order to adjust the center pole individually to the optimum working height. This is done by turning the star knob.

In addition, by pushing down on the star knob, the center pole can be brought into the lower position e.g. to be able to travel through low passages. If the center pole is raised, the respective optimally adjusted working height is once again active.

### ON/OFF switch (red)

With the red ON/OFF switch, the machine is activated for starting with the start button on the center pole head or remote control.

The machine is completely deactivated with the ON/OFF button.

With the ON/OFF switch, the diagnostic and configuration menus can also be called up and menu items can be changed.

### Setting key

Digits of the activation PIN, setup PIN, or machine settings can be adjusted with the black setting key.

### Display and control lamps

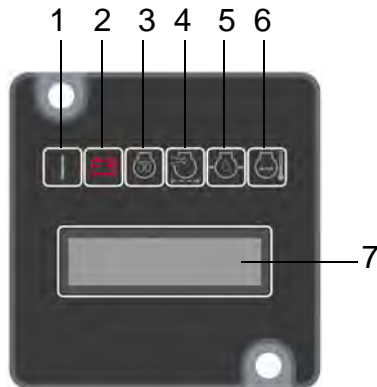

Item	Designation	Item	Designation
1	Control lamp for operation	5	Control lamp for oil pressure
2	Control lamp for charging	6	Control lamp for coolant temperature
3	Control lamp for preheating	7	Display
4	Control lamp for air cleaner		

### Control lamp for operation

The control lamp for operation indicates whether the machine has been activated via the ON/OFF switch.

- The control lamp for operation lights up green when the machine has been activated via the ON/OFF switch.
- The control lamp for operation goes out when the machine has been deactivated via the ON/OFF switch.

### Control lamp for charging

The control lamp for charging indicates whether the starter battery of the machine is being charged.

- The control lamp for charging lights up red when the machine is activated.
- The control lamp for charging goes out when the engine is running.
- The control lamp for charging lights up red when the starter battery of the machine is no longer charged.

### Control lamp for preheating

When the engine is started, the control lamp for preheating indicates whether the glow plugs are being preheated.

- The control lamp for preheating lights up yellow as long as the glow plugs of the engine are preheated during starting.
- The control lamp for preheating goes out when preheating is completed.

### Control lamp for air cleaner

The control lamp for the air cleaner displays the maintenance condition of the air cleaner.

- The control lamp for the air cleaner lights up yellow when the air cleaner is dirty.

### Control lamp for oil pressure

The oil-pressure control lamp indicates whether the oil pressure is sufficient.

- The control lamp for oil pressure lights up red when the machine is activated.
- The control lamp for oil pressure goes out when the engine is running.
- The control lamp for oil pressure lights up red when the oil pressure is too low.

### Control lamp for coolant temperature

The control lamp for coolant temperature indicates whether the coolant temperature is within the permissible range.

- The control lamp for coolant temperature lights up red when the coolant temperature is too high.

### Display

The following information is displayed in sequence:

- Number of operating hours.
- Transmission channel (optional)
- Error statuses.
- Diagnostic menu.
- Configuration menu.

### Diagnostic menu



In the diagnostic menu on the display, the following information about the machine can be accessed:

- Overview of all detected errors (error memory).
- Starter battery voltage.
- Coolant temperature of the engine.
- Hydraulic oil temperature (optional).
- Engine speed.
- Software version (SW version).
- Switch test.
- Transmission test.

### Configuration menu

---

#### NOTICE

The operation of the configuration menu is described in the manual for machine configuration.

---



In the configuration menu on the display, the following machine settings can be adjusted:

- Change/activate/deactivate activation PIN of the machine.
- Setting turn-off time of the machine.
- Select the display language (English, German, French, or Spanish).
- Adjust machine response in the case of overload (overload sensor).
- Setting the hydraulic parameters/centrifugal force.
- Change setup PIN.

### 6.3 Components and operator's controls – remote control unit

The remote control of the DPU80r, DPU90r and DPU110r may only be used for these machines.

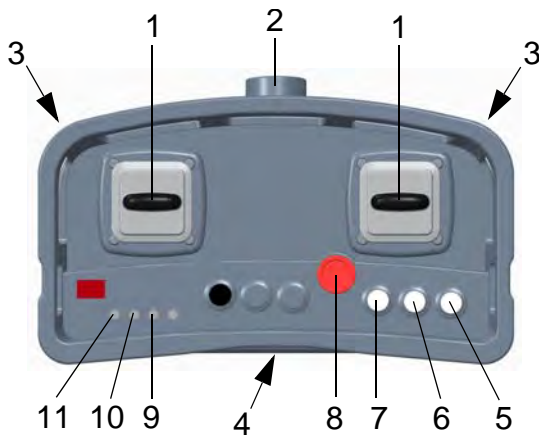

Item	Designation	Item	Designation
1	Joystick (left, right)	7	Engine start button
2	Socket for charging cable	8	ON/OFF switch
3	Carrying strap	9	Control lamp for charging
4	Rechargeable battery	10	Control lamp for operation
5	Spot compaction button	11	Diagnostic control lamp
6	Button for slow/fast operation		

#### Joystick (left, right)

By pressing the joystick, the vibration starts, and the machine moves.

#### ON/OFF switch

The remote control unit is switched on via the ON/OFF switch. When switching off, the remote control and the engine are turned off.

#### Engine start button

The start button starts the engine.

#### Button for slow/fast operation

The slow/fast button is used to switch between slow and fast operation. Fast operation is selected by default.

- Quick mode – operating mode for compacting.
- Slow operation – mode with reduced engine speed to traverse highly compacted or hard surfaces.

#### Spot compaction button

The spot vibration button must remain pressed so that the machine compresses on the spot.

#### Carrying strap

The carrying strap is used to hang the remote control.

#### Rechargeable battery

The rechargeable battery powers the remote control unit. The rechargeable battery can be recharged with the charging cable of the machine or with an external battery charger.

#### Control lamps

##### Charging

- The control lamp for charging lights up green when the rechargeable battery is charging.
- The control lamp for charging goes out once the rechargeable battery is charged.

### **Operation**

- Operation control lamp flashes green when the remote control is switched on.
- The control lamp for operation flashes green when the remote control is switched on.
- The control lamp for operation flashes red when the charge situation of the rechargeable battery is low.
- The control lamp for operation lights up red when the rechargeable battery is discharged.

### **Diagnostics**

- The control lamp for diagnosis briefly flashes green when a joystick is moved or a button on the remote control unit is pressed.

## 7 Transport

**WARNING**

Improper handling may result in injury or serious material damage.

- Please read and follow all safety instructions in this operator's manual.

**DANGER**

Danger from falling.

Falling machines can cause serious injury e.g. through crushing.

- Only use suitable and tested lifting gear and tackle (safety load hooks) of sufficient lifting capacity.
- Only lift the machine from the central lifting point.
- Reliably secure the machine to the lifting gear.
- Do not lift the machine on the central lifting point with a forklift or excavator bucket.
- Do not lift the machine at the control handle.
- Evacuate danger zone while lifting, do not stop under suspended loads.

**WARNING**

Risk of fire and explosion from fuel.

Escaping fuel may catch fire and cause serious burns.

- Lift and transport the machine upright.

### 7.1 Loading and transport

Carry out preparations

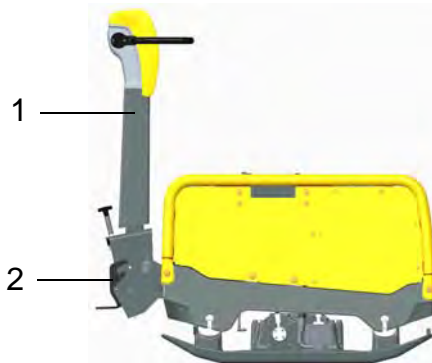

Item	Designation	Item	Designation
1	Center pole	2	Center pole lock

When loading and transporting, the center pole must be locked into place by engaging the locking the center pole lock in the vertical position.

## Lift machine

**NOTICE**

Appoint a specialist flagman for a safe lifting operation.

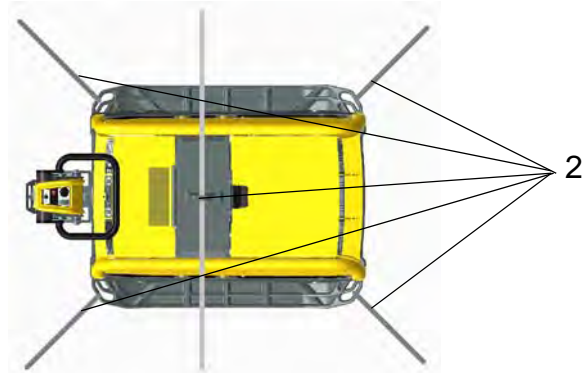

Item	Designation	Item	Designation
1	Central lifting point (attachment point)	2	Tie-down lugs

1. Place the central lifting point in the vertical position.
2. To lift the motor, hang suitable tackle at the central lifting point.
3. Carefully load machine into or onto a stable means of transport.
4. After loading the machine, lash down the machine to prevent it from rolling off, slipping, or tipping over. Attach tie-down lugs to the designated lashing points.

## 8 Operation and use



### WARNING

Improper handling may result in injury or serious material damage.

- Please read and follow all safety instructions in this operator's manual.

### 8.1 Before commissioning

#### 8.1.1 Inspection before commissioning

##### Open protective hoods

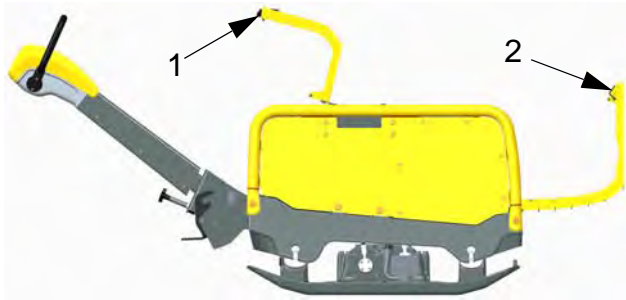

Item	Designation	Item	Designation
1	Hood opener of rear protective hood	2	Hood opener of front protective hood

1. Pull hood opener of rear protective hood until it is unlocked. Completely open protective hood.
2. Pull hood opener of front protective hood until it is unlocked. Completely open protective hood.

##### Complete the following inspections:

- Check the machine and components for damage. If there is any visible damage, do not use the machine and immediately contact the Wacker Neuson service.
- Ensure that loose packaging material has been removed from the machine.
- Ensure that there are no loose items under the protective hoods, e.g. gloves or tools.
- Check fuel level.
- Check the engine oil level.
- Check hydraulic oil level.
- Check the fuel lines for leak tightness.
- Check to ensure the screwed connections are firmly seated.
- Ensure that the receiving units are free of dirt accumulation.

### NOTICE

Perform control procedures according to the *Maintenance* chapter. If necessary, top off missing fuel, lubricants and coolants, see chapter *Technical Data*.

### 8.1.2 Set center pole

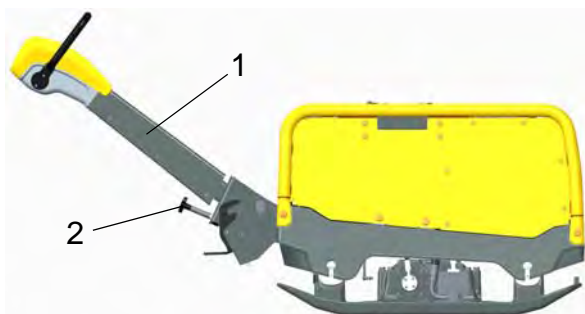

Item	Designation	Item	Designation
1	Center pole	2	Star knob

The optimum working height of the center pole can be adjusted by turning the star knob.

### 8.1.3 Remote controlled machine

#### Remove remote control from the bracket

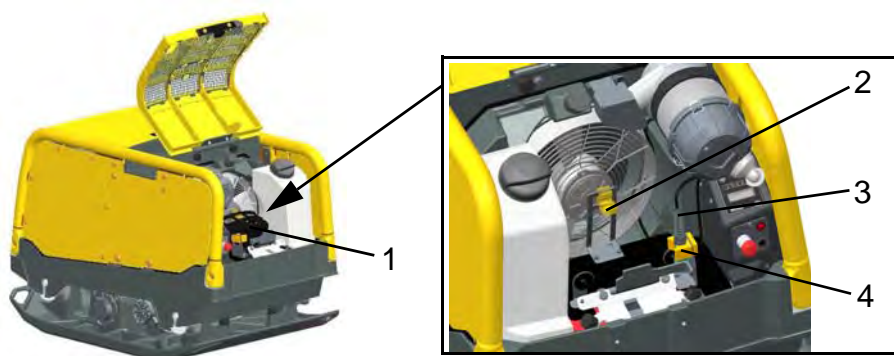

Item	Designation	Item	Designation
1	Remote control	3	Charge cable
2	Bracket for remote control	4	Bracket for charger cable

1. Pull hood opener of rear protective hood until it is unlocked.
2. Completely open the rear protective hood with the hood opener.
3. Unscrew the charging cable from the remote control.
4. Place charging cable in the bracket.

#### NOTICE

Improper handling can result in damage to the charging cable.

- When placing charging cable in the bracket, make sure it will not get pinched when closing the protective hood.

5. Screw screwed nose cap on the connection socket of the remote control.
6. Remove the remote control from the bracket.

#### Check remote control

- Remote control and carrying strap are undamaged.
- Remote control is free of dirt.

**8.2 Notes about operation**



**WARNING**

**Danger of tipping**

There is a serious risk of injury from slipping or tipping over of the machine.

Near edges, at least 2/3 of the machine must be on a load-bearing surface.

- If not, decommission the machine and lift back on a load-bearing surface.



**WARNING**

Health hazard from exhaust fumes

- The exhaust fumes of this engine contain chemicals, which the state of California knows can cause cancer, birth defects or other reproductive damage.

**Operation on sloped surfaces**

- Always stand above the machine within the area of a slope.
- Only approach gradients from below (a gradient that can be easily driven up can also be driven down without any risk).
- Do not stand in the direction of descent of the machine.
- Do not exceed the maximum allowable slanting position (see *Technical Data*) chapter.
- Only operate the machine for a short time in maximum allowable slanting position.

**NOTICE**

If the maximum permissible slanting position is exceeded, this results in a failure of the engine lubrication and therefore inevitably causes a defect of important engine parts.

**Remote-controlled machinery – locational information**

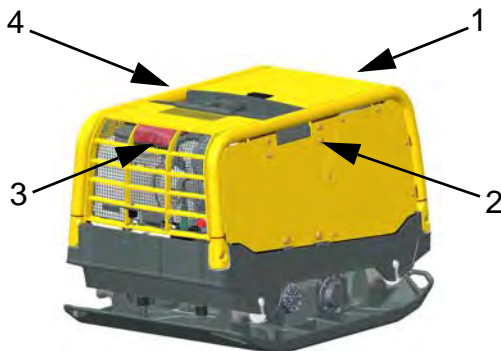

Item	Designation	Item	Designation
1	Front (transparent receiving unit)	3	Rear (rear receiving unit)
2	Right	4	Left

**Remote-controlled machinery – direction of movement**

The direction of movement of the machine is self-contained from the position of the operator. If the joystick of the remote control is pressed forward, the machine moves always forward.



**WARNING**

Mixing up the direction of movement of the machine poses a danger of crushing for others

- Operate the machine from behind and maintain a minimum safety distance of at least 2 meters.
- Ensure that no other individuals are in the proximity area or working area of the machine.

Operator behind the machine	Operator in front of the machine
<p>If the operator is located behind the machine and presses both joysticks forward – the machine moves <b>forward</b> away from the operator.</p>	<p>If the operator is located in front of the machine and presses both joysticks forward – the machine moves <b>backward</b> away from the operator.</p>

**8.3 Commissioning**



**DANGER**

Fire hazard

Jumper cable sprays are highly flammable; they can ignite and cause severe burns.

- Do not use jumper cable sprays.

**8.3.1 Activate machine**



Item	Designation	Item	Designation
1	Control lamps	3	ON/OFF switch (red)
2	Display		

1. Pull hood opener of rear protective hood until it is unlocked.
2. Completely open the rear protective hood with the hood opener.
3. Press the ON/OFF switch on the machine.

- When the machine is activated, all control lamps light up for approx. 1 second.

The following are displayed in sequence:

- Auto-engaging status.
- The transmission channel set on the machine (optional).
- Number of operating hours.

4. Close and lock rear protective hood into place.

### Enter activation PIN

---

#### NOTICE

PIN entry is deactivated by default. If the machine should be secured by an activation PIN, this must be set in the configuration menu; see *Manual for Machine Configuration*.

The activation PIN should always be kept secret and never be listed on the machine or remote control.

---

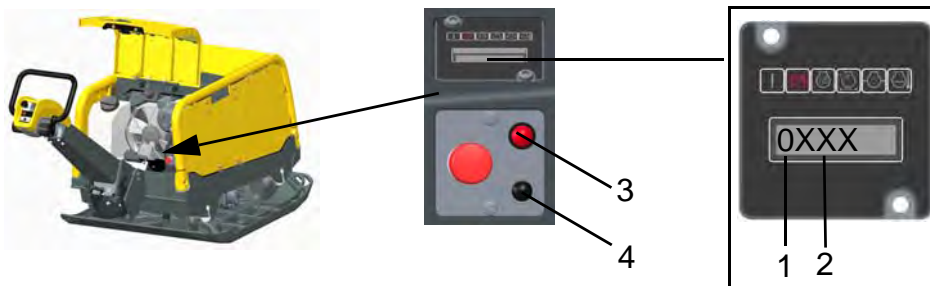

Item	Designation	Item	Designation
1	Digit of the activation PIN	3	ON/OFF switch (red)
2	Position of the activation PIN	4	Adjusting key (black)

---

#### NOTICE

The engine can only be started if the correct activation PIN has been entered with the remote control.

---

1. When the display prompts you to enter the activation PIN, press the ON/OFF switch.
2. Enter activation PIN:

---

#### NOTICE

If an incorrect PIN is entered four times in succession, you must wait five minutes before re-entering the PIN. During the wait time, the request to wait is displayed.

---

- To select the next position, press the ON/OFF switch on the machine.
  - To select the digit, press the selection button repeatedly until the correct value is achieved.
3. Once all of the digits of the activation PIN have been selected, press the ON/OFF switch of the machine.

### 8.3.2 Commission machine (center pole)



Item	Designation	Item	Designation
1	Start button	3	Vibratory rammer
2	Control lamp		

1. The red control lamp on the center pole flashes briefly at intervals of 5 s to signal readiness to start.
2. The vibration switch must be pressed to start (vibration off).
3. Briefly press start button of the center pole – the motor will start automatically.

**NOTICE**

The starting process can take up to 2 minutes. As long as the control lamp is red, the automatic start up runs. Depending on the operating temperature of the engine, the glow plugs are optionally preheated and warmed up.

### 8.3.3 Commission machine (remote control)

**Switch on remote control unit**



Item	Designation	Item	Designation
1	Control lamp for operation	2	ON/OFF switch

1. Press the ON/OFF switch of the remote control unit Operation control lamp flashes green when the remote control is switched on.

**NOTICE**

If the operation-control lamp flashes or lights red, recharge the rechargeable battery.

2. Hang the remote control with the carrying strap.

**Start engine**

Item	Designation
1	Engine start button

1. Directly aim remote control towards a receiver unit.
2. Briefly press start button of the remote control – the motor will start automatically. When the receiving units flash yellow, the machine is ready for operation.

---

**NOTICE**

The starting process can take up to 2 minutes. As long as the receiving units light red, the automatic startup will run. Depending on the operating temperature of the engine, the glow plugs are optionally preheated and warmed up.

---

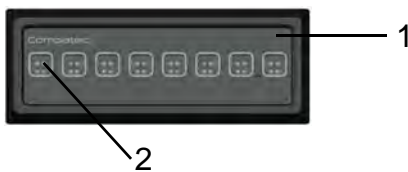
**8.3.4 Machine with Compatec system (optional)**

Item	Designation	Item	Designation
1	Compatec - display unit	2	LEDs/light progress bar

1. During the first few seconds after starting the machine, a light progress bar appears on the Compatec display unit.
2. LEDs light up starting from left to right.

---

**NOTICE**

If all LEDs light up, the Compatec display unit is fault-free. The LEDs will then switch off one after the other.

---

3. All LEDs will briefly light up again at reduced brightness.
4. The sensor is thus successfully tested and the Compatec system is ready for operation.

---

**NOTICE**

If the brief lighting up of all LEDs does not occur, the sensor has not been successfully tested. See *Troubleshooting* chapter.

---

**8.4 Operation**

- In accordance with the intended purpose, the operator should stand behind the machine.
- Guide and steer machine using the control handle.
- Control machine with remote control.

## 8.4.1 Operating machines with center pole

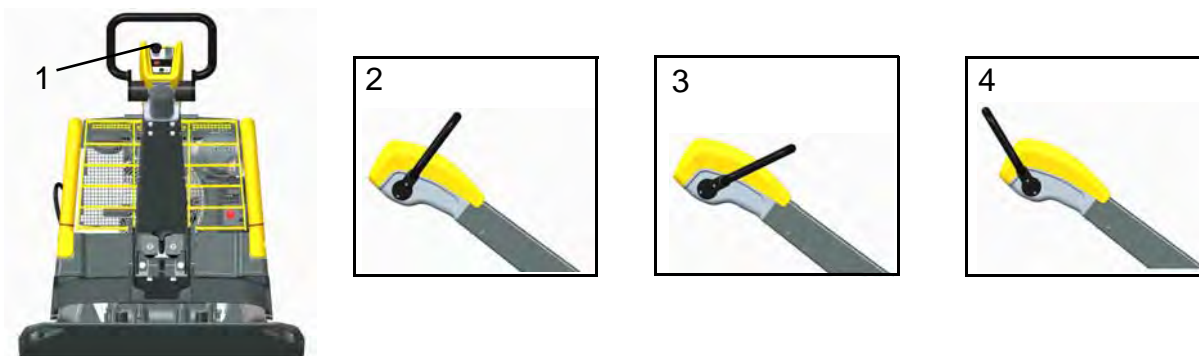

Item	Designation	Item	Designation
1	Vibratory rammer	3	Forward
2	Central position of control handle	4	Reverse

1. Pull vibration switch
2. Select travel direction and speed with the control handle.
  - Speed display by lighting of the slow/fast-rocker switch or flashing for intermediate positions.

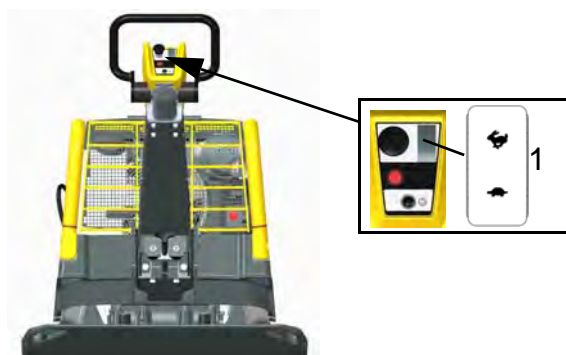
**Switch slow/fast mode on and off**

Item	Designation
1	Slow/fast rocker switch

- Slowly press the slow/fast switch up to increase the speed.
- Slowly press the slow/fast switch down to reduce the speed.

If the control lamp  lights up, the maximum speed is set.

If the control lamp  lights up, the speed is lower than the maximum.







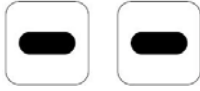

If the control lamp  lights up, the lowest stage is reached.

**NOTICE**

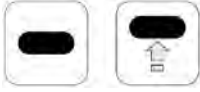
To switch from maximum to minimum (or vice versa) speed, the slow/fast operation button must be pressed for approx. 2–3 s.

### 8.4.2 Operating a remote-controlled machine

The following table shows how the machine moves when the respective joystick of the remote control is operated:

No movement 	
Forward 	Reverse 
Forward left turn 	Forward right turn 
Reverse left turn 	Reverse right turn 
Left stand rotation 	Right stand rotation 

#### Moving and stopping the machine

1. Press the joystick of the remote control to the desired position and hold. The machine starts vibrating and moves in the desired direction – the further the joysticks are pushed forward or backward, the faster the machine moves.
2. Release both joysticks of the remote control. The machine stops moving and vibrating – after approx. 6 s, the engine switches to idle.

#### Switch slow/fast mode on and off

---

##### NOTICE

Fast operation is selected by default.

The slow mode is only intended for traversing highly compressed or hard surfaces.

---

1. Press slow/fast mode button to switch between slow and fast operation.
  - When the receiving units flash yellow, the machine is in slow mode.

#### Switching stand vibration on and off

1. Pressing and holding stand vibration button – The machine compresses on the spot without moving in one direction.
2. Releasing stand vibration button – The machine will return to normal operating condition.

### 8.4.3 Machine protection – installation (optional)

To protect the machine, a warning is activated in the event of an overload:

- The red control lamps on the center pole flash.
- The receiving units flash red.
- Alternating flashing of the LEDs of the Compatec display unit (optional).

In addition, a machine response can be set in the configuration menu:

- Switching off the machine.
- Switch-over to slow mode.
- Reduced power operation.

### 8.4.4 Read the Compatec display unit (optional)

This display roughly indicates the progress of the compaction.

---

**NOTICE**

The functionality of the machine protection installation is integrated. See the chapter *Machine protection installation*.

---

**NOTICE**

The brightness of the LED automatically adjusts to the light conditions of the working area.

---

- The number of LEDs lit is proportional to the soil density, more illuminated LEDs corresponds to a higher soil density.

---

**NOTICE**

It is possible to detect non-compactable material if the spot is longer than one meter. In the case of abrupt change from high to low-compacted soil (or vice versa), there is a slow increase or decrease of the LEDs.

---

**NOTICE**

The LED bar utilization of the Compatec display unit is tailored to soils that can be compacted easily. A soil density that is well beyond the achievable values of soils that can be compacted easily is signaled by the flashing of all LEDs.

---

**NOTICE**

If the machine is operated in reduced power mode

- Preselected using the slow/fast rocker switch or button.
- Overload setting in the configuration menu.

No LEDs of the Compatec display unit are illuminated.

---

## 8.5 Decommissioning

### 8.5.1 Decommissioning the machine (center pole)



Item	Designation	Item	Designation
1	Vibratory rammer	2	Start button

1. Press vibration switch – Vibration switches off and machine stops.
2. Press the start button – the engine switches off.

---

**NOTICE**

The Compeatec display unit automatically switches itself off once the machine is turned off.

---

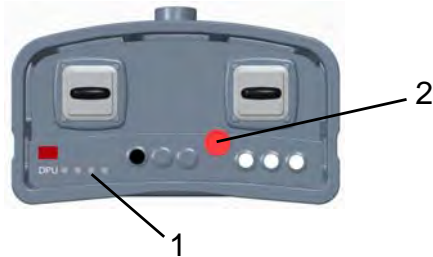
**8.5.2 Decommissioning the machine (remote control)**
**Switch off remote control and engine**

Item	Designation	Item	Designation
1	Control lamp for operation	2	ON/OFF switch

1. Release both joysticks of the remote control.
2. Directly aim remote control towards a receiver unit.

---

**NOTICE**

If the remote control is not directly aimed at the receiving unit, only the remote control will be switched off.

---

3. Press the ON/OFF switch of the remote control to turn off the engine and remote control – the operation control lamp switches off when the remote control is switched off.

---

**NOTICE**

The remote control automatically switches off after about 10 minutes if no control of the joystick or touch controls takes place.

---

**8.5.3 Deactivate machine**



---

**WARNING**

Operation of the machine by unauthorized persons can lead to serious injury.

- Ensure that no unauthorized persons have access to the machine and remote control.
  - Always keep the remote control in a safe place, e.g. within the locked machine.
-

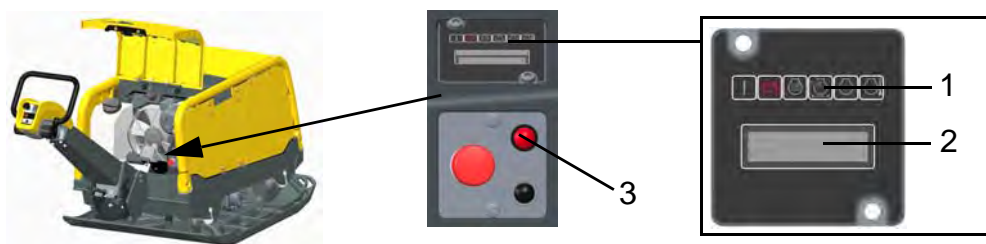

Item	Designation	Item	Designation
1	Control lamps	3	ON/OFF switch (red)
2	Display		

1. Open rear protective hood.
2. Press the ON/OFF switch on the machine in order to deactivate it. If the operation and receiving unit control lamps turn off, the machine is deactivated.
3. Charge rechargeable battery of the remote control with the charger cable.
4. Close rear protective hood.

---

**NOTICE**

If the machine is not deactivated, it will automatically deactivate after about 15 minutes (center pole machine) or after about 1 hour (remote controlled machine).

The deactivation time can be set in the configuration menu.

---

**Decommissioning the machine in an emergency situation (emergency stop)**

---

**NOTICE**

The emergency stop switch is a safety device and should only be used for the immediate switch off of the machine in the case of an emergency situation.

---



Item	Designation
1	Emergency stop switch

1. Pressing the emergency stop switch – The machine will immediately stop moving and vibrating and will automatically deactivate itself.
  - To unlock, turn the emergency stop switch to the left. The machine can then be re-activated.

### 8.5.4 Charge rechargeable battery (remote control)

---

**NOTICE**

Charging the battery at temperatures below 0°C may not be possible.

---

#### Charging rechargeable battery with charging cable

---

**NOTICE**

After connecting the charging cable to the remote control, the rechargeable battery is loaded. Overcharging the battery is not possible; the charging cable must not be disconnected from the remote control after charging. Note that after a longer downtime/ service life of the machine, the rechargeable battery charges more slowly. It may need to be recharged.

A charging time of 15 min is sufficient to operate the machine for about 1 h.

---

#### Connecting the charging cable

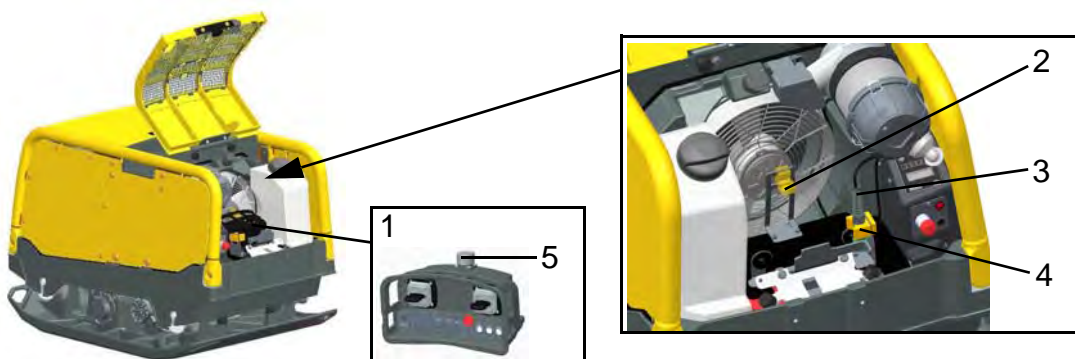

Item	Designation	Item	Designation
1	Remote control	4	Bracket for charger cable
2	Bracket for remote control	5	Socket with screwed nose cap
3	Charge cable		

---

**NOTICE**

Improper handling can result in damage to the charging cable.

- When using charging cable, make sure it will not get pinched when closing the protective hood.
- 

1. Open rear protective hood.
2. Unscrew screwed nose cap from the connection socket of the remote control.
3. Remove the charging cable from the bracket.
4. Plug charger cable into the connector on the remote control and screw in.

---

**NOTICE**

- The loading of the remote control lamp lights up green when the rechargeable battery is charging.
  - The loading of the remote control lamp goes out once the rechargeable battery is charged.
- 

5. Place remote control in the bracket.
6. Close rear protective hood.

### 8.5.5 Rechargeable battery charger with external charging device (optional)

Only use external battery chargers from Wacker Neuson.

#### Remove rechargeable battery from the remote control

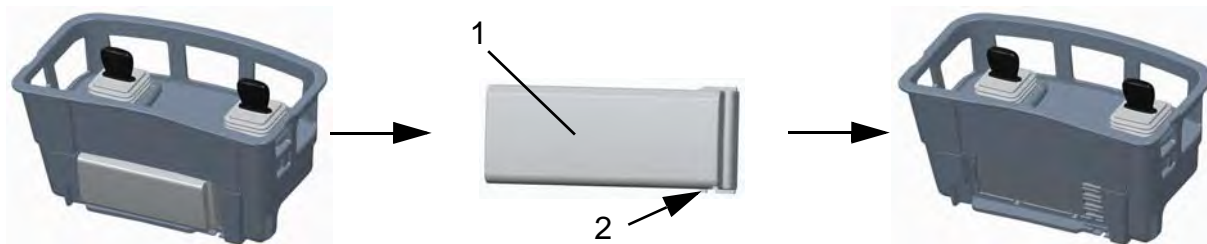

Item	Designation	Item	Designation
1	Rechargeable battery	2	Clip

1. Press the clip and simultaneously pull the rechargeable battery to the right.

#### Rechargeable battery charger with external charging device

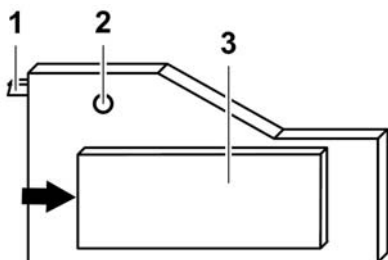

Item	Designation	Item	Designation
1	Plug receptacle	3	Rechargeable battery
2	Status control lamp		

#### NOTICE

Before the first charging, read the operator's manual for the battery charger.

1. Insert rechargeable battery into external battery charger.
2. Connect country-specific connector to the battery charger.
3. Insert the plug of the battery charger into the plug receptacle.

#### NOTICE

- The status control lamp lights up orange when the rechargeable battery is charging.
- The status control lamp flashes orange when the rechargeable battery is completely charged.

4. Once the rechargeable battery is charged, remove the plug receptacle from the socket.
5. Remove rechargeable battery from the external battery charger.

#### Insert rechargeable battery into the remote control



1. Push rechargeable battery into the remote control until the clip snaps into place.

## 8.6 Setting the transmission channel (remote control)

The machine can only be operated if the transmission channel of the remote control corresponds to the transmission channel of the machine. The supplied remote control corresponds uniquely with each machine.

### The IR address is displayed:

- Label on decoder in the electrical box.
- In the display after the machine activation.

### In the following cases, an adjustment of the transmission channel may be required:

- If the remote control has been replaced by another.

### Synchronize transmission channel between remote control and machine.

1. Switch on remote control unit.
2. Activate machine.
3. Remove the charging cable from the bracket.
4. Unscrew screwed nose cap from the connection socket of the remote control.
5. Plug charger cable into the connector on the remote control and screw in.
6. Directly aim remote control towards the receiver unit.
  - IR transfer, Address comparison is displayed. If the receiver units flash yellow and the display shows the operating hours, the synchronization of the transmission channel is complete.
7. Unscrew the charging cable from the remote control.
8. Place charging cable in the bracket.

---

#### NOTICE

After synchronizing the remote control to a machine, only the synchronized machine can be controlled with the remote control.

---

---

#### NOTICE

Improper handling can result in damage to the charging cable.

- When using charging cable, make sure it will not get pinched when closing the protective hood.
- 

9. Screw screwed nose cap on the connection socket of the remote control.

## 8.7 Operating the diagnostic menu

### Call up diagnostics menu

1. Activate machine.
2. Press ON/OFF switch on machine for at least 3 seconds.
3. Press the ON/OFF switch on the machine until the desired menu item appears on the display.
4. After finishing the configuration, the diagnosis menu is automatically exited.

### Call up error memory

In the error memory, all errors (maximum 56) are stored along with an associated error code. In addition, the operating hour in which the error occurred is stored.

The system assigns a consecutive number for each error. The most recent error is stored under the highest number.

### The following information alternately displayed:

- Consecutive number, hour of operation, error code.
- Error message.

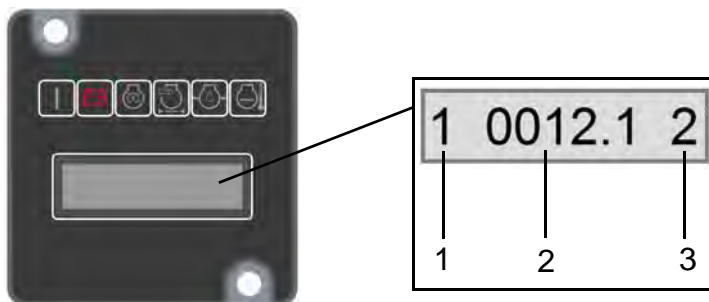

Item	Designation	Item	Designation
1	Consecutive number	3	Error code
2	Operating hours		

1. In the diagnostics menu, select the error memory.
2. To select the stored error, repeatedly press the black setting button until the desired area appears.
3. To exit the error memory, press the red ON/OFF switch.

### 8.8 Operation of the configuration menu

The operation of the configuration menu is described in the manual for machine configuration.

## 9 Maintenance

**WARNING**

Improper handling may result in injury or serious material damage.

- Please read and follow all safety instructions in this operator's manual.

**WARNING**

Danger of poisoning from exhaust fumes.

Exhaust fumes contain poisonous carbon monoxide, which can lead to unconsciousness or to death.

- Only perform maintenance jobs with the engine switched off and the machine decommissioned.

**WARNING**

Risk of injury from uncontrolled starting of the machine and moving parts.

- Only perform maintenance jobs with the engine switched off and the machine decommissioned.

**WARNING**

Risk of fire and explosion from fuel and fuel vapors.

Fuel and fuel vapors may ignite or catch fire and cause serious burns.

- Do not smoke.
- Do not refuel near open flames.
- Switch off the engine and allow to cool before refueling.

**WARNING**

Warning of hot surfaces

The exhaust system and engine can become extremely hot, which can lead to severe skin burns.

- Always allow the engine to cool down completely after use.
- If there is not enough time to allow the machine to cool down (e.g. in an emergency situation.) – use heat-resistant protective gloves.

**WARNING**

Risk of injury due to non-existent or non-functioning safety devices.

- Only operate the machine if the safety devices are properly fixed and functioning.
- Do not modify or remove safety devices.

### 9.1 Maintenance schedule – One-time maintenance job

The following maintenance jobs must only be performed after the first commissioning in accordance with this interval.

Maintenance jobs	After the first 50 hours
Replace engine oil and oil filter of the drive motor.	■

## 9.2 Maintenance schedule – daily maintenance jobs

Maintenance jobs	before operation	after operation
Inspect for completeness.	■	
Visual inspection for damage and leaks.	■	
Check engine oil level and top off if necessary.	■	
Check coolant level and top off if necessary.	■	
Check radiator for dirt and clean if necessary.	■	
Check the operation of the emergency stop switch.	■	
Clean machine and remote control.		■

## 9.3 Maintenance schedule – regular intervals

Maintenance jobs	every 125 h	every 250 h	every 500 h
Make sure the screwed connections are firmly seated: <ul style="list-style-type: none"> <li>■ Center brace.</li> <li>■ Central lifting point.</li> <li>■ Hydraulic tank.</li> <li>■ Rubber buffer of the base plate.</li> </ul>	■		
Check exciter oil level.	■		
Check hydraulic oil level.	■		
Check hydraulic hose lines.*	■		
Check hydraulic oil level on the center pole.	■		
Check the rubber buffer of the base plate.*	■		
Check function of the proximity recognition sensor (remote control).	■		
Lubricate latches of the protective hood	■		
Check central lifting point for damage.	■		
Replace engine oil and oil filter of the drive motor.		■	
Replace fuel filter.*		■	
Check coolant hoses and clamps.*		■	
Check anti-frost layer of radiator		■	
Check the hosepipes and clamps of the air intake system.*		■	
Replace air cleaner cartridge. If the control lamp lights up, even before reaching the interval.		■	
Replace exciter oil. *		■	
Check the V-belt of the generator – tighten *.		■	
Check the rubber buffers on the protective hoods, hinges and locks for pretension.		■	
Replace the hydraulic oil filter with air cleaner.*			■
Check the tapped clearance, adjust if necessary.*			■
* Have this work performed by the service department of your Wacker Neuson contact partner.			

Maintenance jobs	every 1000 h/every 2 years	every 4000 h/every 4 years	every 6 years
Replace coolant.*	■		
Replace the hydraulic oil.*	■		
Replace the tooth belt pulley of the engine.*		■	
Replace the hydraulic hose lines.*			■
* Have this work performed by the service department of your Wacker Neuson contact partner.			

## 9.4 Maintenance jobs



### CAUTION

Health risk from fuel, lubricants and coolants.

- Do not inhale fuel, lubricants, coolants or vapors.
- Avoid contact of skin or eyes with fuel, lubricants and coolants.

### Carry out preparations

1. Place the machine on a level surface.
2. Decommissioning the machine.
3. Deactivate machine.
4. Allow engine to cool down.

#### 9.4.1 Check the fuel level and top off



### WARNING

Risk of fire and explosion from fuel and fuel vapors.

- Do not smoke.
- Do not refuel near open flames.
- Switch off engine and allow to cool before refueling. Only refuel in a well-ventilated vicinity.



Item	Designation	Item	Designation
1	Limit mark	3	Fuel filter
2	Fuel cap		

1. Open rear protective hood.
2. Remove dirt accumulation in the area of the fuel cap.

3. Unscrew the fuel cap of the fuel tank and remove it.
4. If necessary, remove and clean the dirty fuel filter. Reinsert fuel filter before topping up.
5. Top off fuel to the limit mark – for fuel type, see *Technical Data* chapter.
6. Replace fuel cap and tighten.
7. Close rear protective hood.

---

**NOTICE**

Dispose of impurities of the fuel filter in accordance with the applicable provisions for environmental protection.

---

**9.4.2 Clean machine and remote control**



---

**WARNING**

Risk of fire and explosion when using flammable cleaning agents.

- Do not clean machine, components, or operator's controls with gasoline or other solvents.
- 

---

**NOTICE**

Permeating water can damage the engine, electrical operator's controls, or components of the machine and remote control. Do not aim high pressure washer directly at air intake area and electrical elements. Clean remote control with only a damp cloth.

---

1. After cleaning, check switches, levers, cables, hoses, pipes and hardware for leaks, loose connections, abrasions and other damage.
2. Immediately eliminate detected damage.

**9.4.3 Check engine oil level and top off engine oil**

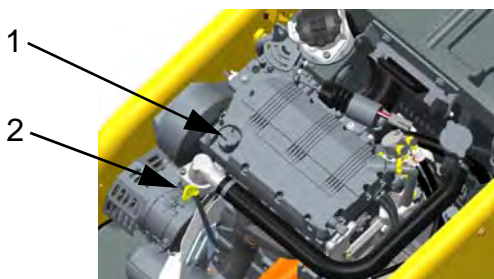

Item	Designation	Item	Designation
1	Cover of the oil filler opening	2	Oil-level dipstick

**Check engine oil level**

1. Open both protective hoods.
2. Remove dirt accumulation in the area of the oil-level dipstick.
3. Pull out oil-level dipstick.
4. Wipe oil-level dipstick with a dry, lint-free cloth.
5. Fully reinsert oil-level dipstick
6. Pull out oil-level dipstick.
7. Check whether the oil is between the lower and upper mark of the oil-level dipstick.

**Top off motor oil**

1. Remove dirt accumulation in the area of the oil filler opening.
2. Remove cover of the oil filler opening.

3. If necessary, fill with engine oil with a funnel until the upper mark of the oil-level dipstick is reached – for the oil specification and quantity, see the *Technical Data* chapter.
4. Put the cover back on the oil filler opening and press firmly.
5. Wipe away any spilled oil.

---

**NOTICE**

Dispose of oil in accordance with the applicable provisions for environmental protection.

---

**9.4.4 Replace motor oil**

---

**NOTICE**

Change oil in lukewarm engine so that the oil can drain completely.

---



Item	Designation	Item	Designation
1	Cover of the oil filler opening	3	Oil filter
2	Oil-level dipstick	4	Oil drain plug

**Drain the engine oil and replace the oil filter**

1. Open the front protective hood.
2. To protect the floor from leaking oil, cover the working surface with an impermeable foil.
3. Place collecting container under the oil drain plug.
4. Loosen oil drain plug.
5. Place a sufficiently large collecting container under the oil filter.
6. Unscrew and remove oil filter – when unscrewing, collect any leaking oil.
7. When the oil has completely drained, screw in the oil drain plug and tighten.
8. Screw in a new oil filter and tighten with 20 Nm.

---

**NOTICE**

Dispose of oil in accordance with the applicable provisions for environmental protection.

---

**Fill motor oil**

1. Remove dirt accumulation in the area of the oil filler opening.
2. Remove cover of the oil filler opening.
3. If necessary, fill with oil until the upper mark of the oil-level dipstick is reached – for oil specification and amount of oil, see *Technical Data* chapter.
4. Put the cover back on the oil filler opening and press firmly.
5. Wipe away any spilled oil.
6. Briefly allow the engine to run.
7. Switch off engine.
8. Check oil level and top off if necessary.

9.4.5 Check/clean/replace air cleaner

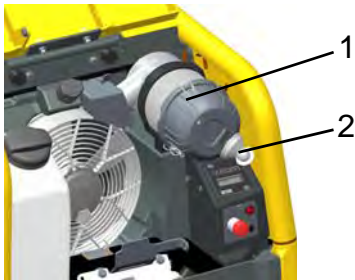

Item	Designation	Item	Designation
1	Air cleaner	2	Dust discharge valve

1. Open rear protective hood.

**Check air cleaner**

- Check whether the clamps of the air cleaner are tight and the air cleaner is undamaged.
- Check whether the dust discharge valve is dirty. If necessary, squeeze dust discharge valve to remove the dirt.

**Replace air cleaner cartridge**



Item	Designation	Item	Designation
1	Air cleaner cartridge	3	Clamps (3 pieces)
2	Lower housing part		

2. Loosen clamps and remove lower housing part
3. Remove air cleaner cartridge.
4. Clean lower housing part.
5. Insert air cleaner cartridge.
6. Replace lower housing part and seal clamps.

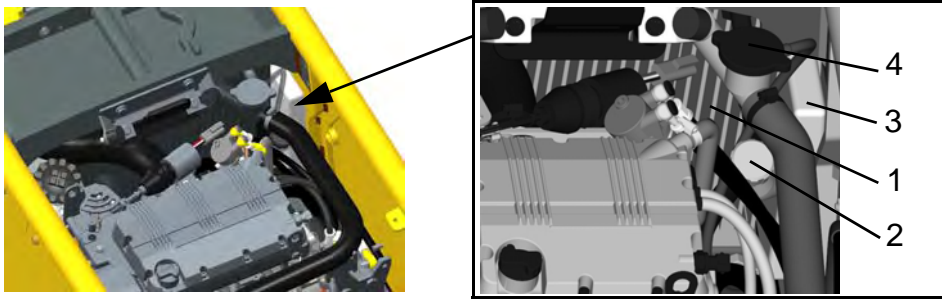
**9.4.6 Check the coolant level and top off coolant**

Item	Designation	Item	Designation
1	Radiator	3	Coolant reservoir
2	Cover of the coolant reservoir	4	Radiator cap

**Check the coolant level in the coolant reservoir**

1. Open the front protective hood.
2. Remove dirt accumulation in the area of the coolant reservoir.
3. The coolant expansion tank should be filled 1/4 to 1/2 in a cold state.

**Top off coolant in the coolant reservoir**

1. Unscrew and remove cover of the coolant reservoir.
2. If necessary, top off the coolant until the coolant expansion tank is filled 1/3 – for the coolant specification, see the *Technical Data* chapter.
3. Replace cover of the coolant reservoir and tighten.

**Check the coolant level in the radiator****WARNING**

The cooling system is under pressure.

Hot coolant can spurt out and cause injury from scalding.

- Only open the cover of the radiator after the engine has cooled down.

1. Remove dirt accumulation in the area of the radiator cover.
2. Slowly unscrew the radiator cap and remove.
3. Check whether the coolant reaches the upper edge of the filler opening.

**Top off coolant in the radiator****NOTICE**

If the machine is losing coolant, check the cooling system for leaks, and have the machine repaired by the service of the Wacker Neuson contact person.

1. If necessary, top off the coolant to the upper edge of the filler opening – for the coolant specification, see the *Technical Data* chapter.
2. Replace radiator cap and tighten.

### 9.4.7 Check exciter oil level and top off exciter oil

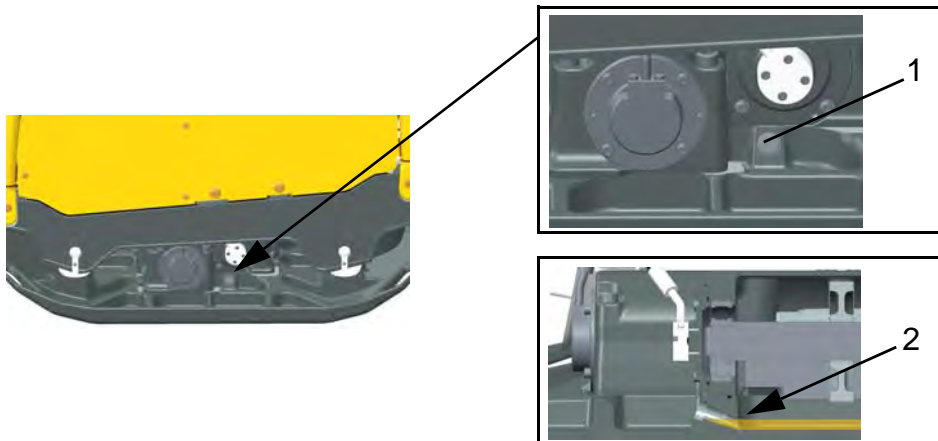

Item	Designation	Item	Designation
1	Screw plug with seal ring of the oil filler / drain opening	2	Level of exciter oil

#### Check the exciter oil level

1. Open rear protective hood.
2. To protect the floor from leaking oil, cover the working surface with an impermeable foil.



#### WARNING

Hot exciter oil can leak out and cause injury from scalding.

- Do not open the screw plug of the exciter while the exciter oil is still hot.
- Let the machine cool.

3. Remove dirt accumulation in the area of the screw plug.
4. Unscrew the screw plug of the oil filler / drain opening and remove together with the seal ring.
5. Check whether the level of exciter oil reaches the lower thread of the tapped bore.

#### Top off the exciter oil

1. Top off the exciter oil with a clean funnel at the oil filler / drain opening until the exciter oil reaches the lower thread – for the oil specification, see the *Technical Data* chapter.
2. Screw in the screw plug of the oil filler / drain opening along with a new seal ring and tighten (torque setting of 100 Nm).
3. Wipe away any spilled oil.

#### NOTICE

Dispose of oil in accordance with the applicable provisions for environmental protection.

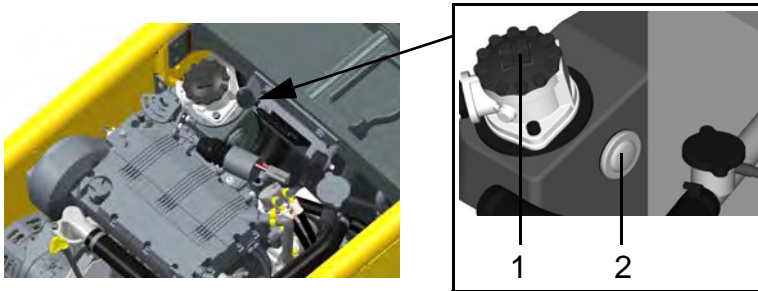
**9.4.8 Check hydraulic oil level and top off hydraulic oil**

Item	Designation	Item	Designation
1	Cover of the hydraulic oil tank	2	Oil level glass

**Check hydraulic oil level**

1. Open both protective hoods.
2. Check whether the hydraulic oil reaches the upper edge of the oil level glass.

**Top off hydraulic oil**

---

**NOTICE**

If the machine is losing hydraulic oil, check the hydraulic line for leaks, and have the machine repaired by the service of the Wacker Neuson contact person.

---



---

**WARNING**

Hot hydraulic oil can cause injury by scalding.

- Do not open the cover of the hydraulic oil tank while the hydraulic oil is still hot.
  - Let the machine cool.
- 

3. Remove dirt accumulation in the area of the hydraulic oil tank.
4. Unscrew and remove cover of the hydraulic oil tank.
5. Top off hydraulic oil until the hydraulic oil reaches the middle of the oil level glass – for oil specification, see *Technical Data* chapter.
6. Replace cover of the hydraulic tank and tighten (torque setting of 10 Nm) – make sure that the seal of the cover fits properly.

**9.4.9 Screwed connections**

For the vibratory plates, the screwed connections must be regularly checked for a firm seat.

## 10 Troubleshooting



### DANGER

Danger to life from unauthorized troubleshooting.

- If faults occur with this machine that are not described in this manual, contact the manufacturer. Do not eliminate the faults independently.

### 10.1 Troubleshooting table – machine

Fault	Possible causes	Remedial measure
Motor will not start.	Emergency stop switch is pressed.	Unlock emergency stop switch.
	Machine is not activated.	Activate machine.
	Discharge starter battery.	Load starter battery or perform jump-start with donor starter.
	Low oil level	Top up oil and actuate valve hood on the oil filter housing.
	Low fuel.	Top up fuel.
	Fuel filter is dirty.	Replace fuel filter.*
	Defective starter motor.	Have the machine repaired.*
	Remote control, decoder, or wiring harness is defective.	
Engine runs unevenly.	Fuel filter is dirty.	Replace fuel filter.*
	Air cleaner is dirty.	Clean or replace air cleaner.
Vibration will not start.	Electrical system defective.	Have the machine repaired.*
Engine smokes and does not perform.	Air cleaner is dirty.	Replace air cleaner.
Machine cannot be activated.	Incorrect activation PIN entered.	Enter the correct activation PIN.
	Electrical system defective.	1. Deactivate machine with emergency stop switch. 2. Have the machine repaired.*
Diagnostics menu cannot be called up.	On / off switch of the machine not pushed long enough.	Continuously press the ON/OFF switch of machine for at least three seconds.
Compatec display unit (optional): Light progress bar does not appear upon initialization.	Compatec display unit or wiring harness defective.	Have the machine repaired.*
Compatec display unit (optional): Short lighting up of all LEDs does not occur upon initialization.	Overload sensor or electrical connection is defective.	
* Have this work performed by the service department of your Wacker Neuson contact partner.		



**10.2 Troubleshooting table – receiving units**

<b>Fault</b>	<b>Possible causes</b>	<b>Remedial measure</b>
Receiver units light up yellow. Machine does not respond to commands from the remote control.	Remote control is switched off.	Switch on remote control unit.
	Rechargeable battery of the remote control is discharged.	Load or replace rechargeable battery of the remote control.
	Remote control is defective.	Have remote control replaced or repaired.*
	Operator is outside of the receiving area.	Enter the receiving area of the machine.
	No clear line of sight between the remote control and receiver unit.	Establish a clear line of sight with the receiving unit.
	Receiving units or remote control is dirty.	Clean remote control and receiving units.
	Decoder, receiver unit, or electrical connection is defective.	Have the machine repaired.*
Receiver units flash yellow in rapid succession. Machine does not respond to commands from the remote control.	Operator is located in the proximity area.	Leave the proximity area of the machine.
Receiver units light up red.	Machine is in the warm-up phase.	Wait until the warm-up phase has completed.
	Diagnostic system has detected an error.	Check control lamps and fault indications on the display.
Receiver units flash red.	Machine is overloaded because the soil cannot be compacted any further.	<ul style="list-style-type: none"> <li>■ Avoid operation on non-compactable soil.</li> <li>■ Reduce the compaction performance by actuating the slow / fast rocker switch.</li> <li>■ Switch-over from fast to slow operation.</li> </ul>
* Have this work performed by the service department of your Wacker Neuson contact partner.		







**10.3 Fault table - Center pole head control lamp**

<b>Fault</b>	<b>Possible causes</b>	<b>Remedial measure</b>
The control lamp illuminates red.	Machine is in the warm-up phase.	Wait until the warm-up phase has completed.
	Diagnostic system has detected an error.	Check control lamps and fault indications on the display.
The control lamp flashes red.	Machine is overloaded because the soil cannot be compacted any further.	<ul style="list-style-type: none"> <li>■ Avoid operation on non-compactable soil.</li> <li>■ Reduce the compaction performance by actuating the slow / fast rocker switch.</li> <li>■ Switch-over from fast to slow operation.</li> </ul>

10.4 Troubleshooting chart – remote control

Pictogram	LED under pictogram	Possible causes	Remedial measure
	Diagnostics control lamp flashes green. In addition, the operation control lamp illuminates red.	Joystick is defective.	Have the joystick replaced.*
		Remote control is defective.	Have remote control replaced or repaired.*
	Control lamp flashes or lights up red operation.	Rechargeable battery of the remote control is discharged.	Load or replace rechargeable battery of the remote control.  Operate machine with charging cable (for simultaneous loading of the rechargeable battery).
	After switching on the remote control, the operation control lamp does not flash.	Rechargeable battery of the remote control is discharged.  Remote control is defective.	Load or replace rechargeable battery of the remote control.  Have remote control replaced or repaired.*
	Charging control lamp flashes green.	The rechargeable battery is automatically being pre-warmed for charging. Charging the battery at temperatures below 0°C may not be possible.	<ul style="list-style-type: none"> <li>■ Wait until the charging control lamp is green and charging begins.</li> <li>■ Rechargeable battery at temperatures above 0°C.</li> </ul>
<b>Remote control switches itself off – if no button on the remote control is pressed, the remote control will automatically switch off after 10 minutes.</b>			
* Have this work performed by the service department of your Wacker Neuson contact partner.			

**10.5 Troubleshooting table – display**

Pictogram	LED under pictogram	Possible causes	Remedial measure
	Control lamp for operation.		
	Charging control lamp lights up red when the engine is running.	Error in the electric system.	Have the machine repaired.*
	Warm up control lamp lights up yellow.	Machine is in the startup process.	Wait until the engine starts.
	Air cleaner control lamp lights up yellow.	Air cleaner cartridge is dirty.	Replace air cleaner cartridge.
	Oil-pressure control lamp lights up when the engine is running.	Engine oil level is too low.	Top up motor oil.
		Oil pressure switch or electrical connection is defective.	Have the machine repaired.*
	Coolant-temperature control lamp lights red.	Cooling fins of the cooler are dirty.	Blow cooling fins with compressed air from the inside to the outside from a safe distance.
		Coolant level is too low.	Top up coolant.
		Cooling system is leaking.	Have the machine repaired.*
* Have this work performed by the service department of your Wacker Neuson contact partner.			

**Fault indications on the display**

If the error is corrected, the error message should be acknowledged in the diagnostic menu because the error is no longer relevant for further operation.

To acknowledge the last error, the diagnostic menu must be called up and exited.

Error code	Display	Possible causes	Remedial measure	
1	Oil pressure shutdown	Engine oil level is too low.	1. Deactivate machine. 2. Top up motor oil.	
		Oil pressure switch or electrical connection is defective.	Have the machine repaired.*	
2	Excess temperature shutdown	Coolant level is too low.	Top up coolant.	
		Cooling system is leaking.	Have the machine repaired.*	
		Engine is overheated.	Allow engine to cool down.	
		Cooling fins of the cooler are dirty.	Blow cooling fins with compressed air from the inside to the outside from a safe distance.	
		Temperature sensor or electrical connection is defective.	Have the machine repaired.*	
		Electric fan is defective.		
3	Peak in the mains supply shutdown	Charge controller or electrical connection is defective.	Have the machine repaired.*	
4	Battery error	Alternator, charge controller, battery, or electrical connection is defective.		
5	Charge controller/ generator shutdown.	Alternator, charge controller, or electrical connection is defective.		
6	Battery error	Alternator, charge controller, battery, or electrical connection is defective.		
7	Check air cleaner	Air cleaner cartridge is dirty.		Replace air cleaner cartridge.
		Electrical connection of the air cleaner sensor is defective.		Have the electrical connection of the air cleaner sensor checked.*
8	Air cleaner error	Air cleaner sensor is defective.	Have the machine repaired.*	
		Electrical connection of the air cleaner sensor is defective.	Have the electrical connection of the air cleaner sensor checked.*	
9	Oil pressure switch shutdown	Oil pressure switch or electrical connection is defective.	Have the machine repaired.*	
10	Charge controller error	Charge controller or electrical connection link to the generator is defective.		
11	Charge controller/ generator error.	Alternator, charge controller, or electrical connection is defective.		
12	Overload shutdown	Machine is overloaded, because the soil density is too high.	Deactivate the machine and then re-activate it.	
		<p>To prevent overload, observe the following rules:</p> <ul style="list-style-type: none"> <li>■ Avoid operation on soils that are too hard to compact.</li> <li>■ Reduce the compaction performance by actuating the slow / fast rocker switch.</li> <li>■ Switch-over from fast to slow operation.</li> </ul>		



<b>Error code</b>	<b>Display</b>	<b>Possible causes</b>	<b>Remedial measure</b>
13	Machine overloaded	Machine is overloaded, because the soil density is too high.	Deactivate the machine and then re-activate it.
		To prevent overload, observe the following rules: <ul style="list-style-type: none"> <li>■ Avoid operation on soils that are too hard to compact.</li> <li>■ Reduce the compaction performance by actuating the slow / fast rocker switch.</li> <li>■ Switch-over from fast to slow operation.</li> </ul>	
14	Overload sensor shutdown	Overload sensor or electrical connection is defective.	Have the machine repaired.*
15	Address comparison of IR transfer	No fault. Transmission channel is synchronized between remote control and machine.	
16	Incorrect transmitter unit for IR transfer	Incorrect model of remote control.	Use correct model of remote control.
17	Incorrect address for IR transfer	Transmission channel on the remote control has been incorrectly set.	Synchronize the transmission channel between the machine and remote control.
18	Allow the machine to cool down...	Coolant level is too low.	Top up coolant.
		Engine is overheated.	Allow engine to cool down.
		Cooling fins of the cooler are dirty.	Blow cooling fins with compressed air from the inside to the outside from a safe distance.
		Cooling system is leaking.	Have the machine repaired.*
		Temperature sensor or electrical connection is defective.	
19	Excess temperature of the machine	Coolant level is too low.	Top up coolant.
		Engine is overheated.	Allow engine to cool down.
		Cooling fins of the cooler are dirty.	Blow cooling fins with compressed air from the inside to the outside from a safe distance.
		Cooling system is leaking.	Have the machine repaired.*
		Temperature sensor or electrical connection is defective.	
20	Temperature sensor error	Temperature sensor or electrical connection is defective.	
		At very low external temperatures, the coolant does not reach the required temperature of 55°C during the warm-up phase. The machine will cancel the warm-up phase but is ready for operation.	
21	Automatic start error	Fuel tank is empty.	Top up fuel.
		<ul style="list-style-type: none"> <li>■ Defect in fuel system.</li> <li>■ Engine, diesel valve, or electrical connection of the diesel valve is defective.</li> </ul>	Have the machine repaired.*

Error code	Display	Possible causes	Remedial measure
22	Charge controller/ start error.	Charge controller, starter motor, or electrical connection is defective.	Have the machine repaired.*
		Battery is discharged or defective.	Charge or replace battery.
23	Diesel valve error	Diesel valve is defective. Machine cannot be switched off.	Have the machine repaired.*
24	Gas adjuster error	Fuel tank is empty.	Top up fuel.
		<ul style="list-style-type: none"> <li>■ Gas adjuster or electrical connection is defective.</li> <li>■ Cable pull of the gas adjuster is incorrectly set or is defective.</li> <li>■ 80 A fuse has blown.</li> </ul>	Have the machine repaired.*
25	Hydraulic temperature sensor error	Hydraulic temperature sensor outside of the valid range.	
26	Oil pressure shutdown	Engine oil level is too low.	1. Deactivate machine. 2. Top up motor oil.
		Oil pressure switch or electrical connection is defective.	Have the machine repaired.*
27	Overload sensor error	Overload sensor or electrical connection is defective.	
28	Overload sensor error	Defective overload sensor.	
29	IR receiver error	Incorrect current value.	
30	IR receiver error	No power/not connected.	
31	Shutdown of the center pole unit	No signal/not connected.	
32	Shutdown error of the decoder	Internal error.	
33			
34			
35	Shutdown of the center pole unit	No signal.	
-	Decoder error	Electrical connection in the electrical box is defective.	1. Deactivate machine with emergency stop switch. 2. Have the machine repaired.*
Display of different errors that alternate in direct succession.		Earth connection of the engine / upper mass or electric box / upper mass is loose or defective.	Have the machine repaired.*
* Have this work performed by the service department of your Wacker Neuson contact partner.			

## 10.6 Perform jump start with donor starter battery

If the starter battery of the machine is discharged and the engine does not start, a jump-start with a donor battery is possible.



### WARNING

Risk of explosion from explosive gas.  
Risk of injury from splashing acid.

- Wear safety glasses and protective gloves.
- The donor battery and starter battery of the machine must have the same voltage (12 V).
- Avoid short circuit from reverse polarity (plus to plus, minus to minus).
- Use correct sequence when connecting the jumper cables.

### NOTICE

Use only insulated jumper cables with a conductor cross-section of at least 16 mm<sup>2</sup>.

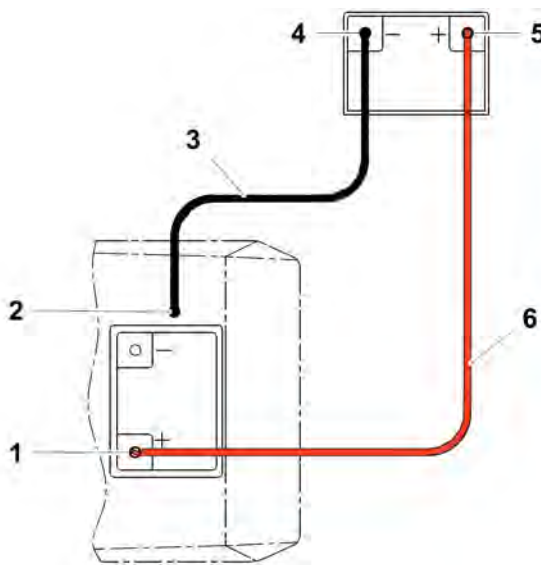

Item	Designation	Item	Designation
1	Positive terminal of the discharged starter battery	4	Negative terminal of the donor starter battery
2	Negative terminal at the grounding point	5	Positive terminal of the donor starter battery
3	Black jumper cables	6	Red jumper cables

1. Connect clamping tongs of the red jumper cable to the positive terminal of the discharged starter battery.
2. Connect clamping tongs of the red jumper cable to the positive terminal of the discharged donor battery.
3. Connect clamping tongs of the black jumper cable to the negative terminal of the discharged donor battery.
4. Reconnect second clamping tongs of the black jumper cable to a grounding point of the machine, e.g. at the engine block.

### Perform jump start

5. Start engine.  
If the engine does not start after a maximum of two minutes, contact your Wacker Neuson contact person.
6. Run engine for a few minutes.

### **Disconnect the jumper cable**

7. Disconnect clamping tongs of the black jumper cable from the grounding point of the machine.
8. Disconnect second clamping tongs of the black jumper cable from the donor starter battery.
9. Disconnect clamping tongs of the red jumper cable from the positive terminal of the discharged starter battery.
10. Disconnect clamping tongs of the red jumper cable from the positive terminal of the discharged donor battery.

## 11 Disposal

### 11.1 Disposal of batteries

The machine contains one or more batteries or rechargeable batteries (hereinafter referred to as "the battery"). Proper disposal of the battery prevents negative effects on individuals and the environment, follows the specific treatment of pollutants, and ensures the recycling of useful raw materials.

#### For customers in EU countries

This battery is subject to the European Directive on (old) batteries and (old) rechargeable batteries, and the respective national laws. The battery directive outlines the framework for an EU-wide treatment of batteries.



The battery is marked with the following symbol of a crossed-out garbage bin. Below this symbol, there is also the name of the pollutants contained therein, i.e. "Pb" for lead, "Cd" for cadmium, and "Hg" for mercury.

**Batteries may not be disposed of with normal household waste!** As an end-user, you may only dispose of used batteries via the manufacturer or specially equipped collection facilities (statutory obligation to return); the delivery is free. Retailers and manufacturers are obliged to take back these batteries and properly recycle them or dispose of them as hazardous waste (legal obligation).

Batteries obtained through Wacker Neuson can be returned to Wacker Neuson free of charge after use. If the batteries cannot be personally returned to a Wacker Neuson branch, there are instructions in the sales contract or in the Terms and Conditions of the location where they were purchased.

#### For customers in other countries

Wacker Neuson recommends that you do not dispose of the battery in normal household waste but rather in a separate, environmentally friendly collection facility. National laws may also have provisions for the separate disposal of batteries. Disposal of the battery in accordance with current national guidelines must be assured.

---

## 12 Accessories

---

**CAUTION**

Accessories and spare parts that do not originate from Wacker Neuson can increase the risk of injury and possible damage to the machine.

- The use of other accessories and spare parts that do not originate from Wacker Neuson shall cancel any liability.
- 

**A wide range of accessories is offered for the machine:**

More information about the individual accessories can be found online at [www.wackerneuson.com](http://www.wackerneuson.com).

**Rechargeable battery**

A replacement rechargeable battery is especially useful when the machine should be used for long periods without interruption.

**External battery charger**

The external battery charger charges the rechargeable battery when it cannot be charged via the charging cable of the machine.

The external battery charger has a country-specific plug to connection to various current networks.



## 13 Technical data

### 13.1 DPU80

Designation	Unit	DPU80Le670	DPU80Le770
Centrifugal force	kN	80	80
Oscillations	Hz	56	56
	1/min	3,380	3,380
Compaction performance	m <sup>2</sup> /h	1,166	1,340
Travel speed*	m/min	29	29
Gradeability	%	34	34
Length (center pole in working position)	mm	2,409	2,409
Width	mm	670	770
Height	mm	1,541	1,541
Operating weight	kg	756	771
Ground clearance	mm	830	830
Electrical load rating	kW	11.0	11.0
Nominal speed	1/min	3,000	3,000
Working pressure of hydraulics	bar	165	165
Maximum allowable hydraulic pressure	bar	230	230
Coolant volume	l	3.8	3.8
Type of coolant		SAE J1034: water (1:1)	SAE J1034: water (1:1)
Exciter oil volume	l	1.35	1.35
Exciter oil type		M 75W90	M 75W90
Hydraulic oil volume	l	17.7	17.7
Type of hydraulic oil		MR 520	MR 520
Storage temperature range	°C	-20 – +50	-20 – +50
Operating temperature range	°C	-10 – +50	-10 – +50
Sound pressure level At location of operation L <sub>pA</sub>	dB(A)	92	92
Standards		EN 500-4	
Sound power level L <sub>wa</sub> measured guaranteed	dB(A)	108	108
		109	109
Standards		EN 500-4, 2000/14/EG	
Vibration total value a <sub>hV</sub>	m/s <sup>2</sup>	< 2.5	< 2.5
	Standards	EN 500-4	
Uncertainty of measurement of the vibration total value a <sub>hV</sub>	m/s <sup>2</sup>	0.5	0.5
* Depending on the soil properties.			

## 13.2 DPU80r

Designation	Unit	DPU80rLe670	DPU80rLe770
Centrifugal force	kN	80	80
Oscillations	Hz	56	56
	1/min	3,380	3,380
Compaction performance	m <sup>2</sup> /h	1,085	1,247
Travel speed*	m/min	27	27
Gradeability	%	34	34
Length (center pole in working position)	mm	1,207	1,207
Width	mm	670	770
Height	mm	833	833
Operating weight	kg	709	724
Ground clearance	mm	830	830
Electrical load rating	kW	11.0	11.0
Nominal speed	1/min	3,000	3,000
Maximum range of remote control	m	20	20
Maximum transmission time of remote control	h	8	8
Recommended battery type		Ni-MH 7.2 V/2000 mAh	Ni-MH 7.2 V/2000 mAh
Battery charging time	h	2	2
Working pressure of hydraulics	bar	165	165
Maximum allowable hydraulic pressure	bar	230	230
Coolant volume	l	3.8	3.8
Type of coolant		SAE J1034: water (1:1)	SAE J1034: water (1:1)
Exciter oil volume	l	1.6	1.6
Exciter oil type		M 75W90	M 75W90
Hydraulic oil volume	l	17.7	17.7
Type of hydraulic oil		MR 520	MR 520
Storage temperature range	°C	-20 – +50	-20 – +50
Operating temperature range	°C	-10 – +50	-10 – +50
Sound pressure level At location of operation L <sub>pA</sub> **	dB(A)	84	84
Standards		EN 500-4	
Sound power level L <sub>wa</sub> measured guaranteed	dB(A)	108	108
		109	109
Standards		EN 500-4, 2000/14/EG	
* Depending on the soil properties.			
** Measured at 5 m distance (remote controlled machine).			



**13.3 DPU90**

Designation	Unit	DPU90Le670	DPU90Le770	DPU90Le770 US
Centrifugal force	kN	90	90	90
Oscillations	Hz	63	63	63
	1/min	3.780	3.780	3.780
Compaction performance	m <sup>2</sup> /h	1.206	1.386	1.386
Travel speed*	m/min	30	30	30
Gradeability	%	34	34	34
Length (center pole in working position)	mm	2.409	2.409	2.409
Width	mm	670	770	770
Height	mm	1.541	1.541	1.541
Operating weight	kg	756	771	771
Ground clearance	mm	830	830	830
Electrical load rating	kW	11,7	11,7	10,7
Nominal speed	1/min	3.350	3.350	3.350
Working pressure of hydraulics	bar	148	148	148
Maximum allowable hydraulic pressure	bar	230	230	230
Coolant volume	l	3,8	3,8	3,8
Type of coolant		SAE J1034: water (1:1)	SAE J1034: water (1:1)	SAE J1034: water (1:1)
Exciter oil volume	l	1,35	1,35	1,35
Exciter oil type		M 75W90	M 75W90	M 75W90
Hydraulic oil volume	l	17,7	17,7	17,7
Type of hydraulic oil		MR 520	MR 520	MR 520
Storage temperature range	°C	-20 - +50	-20 - +50	-20 - +50
Operating temperature range	°C	-10 – +50	-10 – +50	-10 – +50
Sound pressure level At location of operation L <sub>pA</sub>	dB(A)	94	94	94
Standards		EN 500-4		
Sound power level L <sub>wa</sub> measured guaranteed	dB(A)	108	108	108
		109	109	109
Standards		EN 500-4, 2000/14/EG		
Vibration total value a <sub>hV</sub>	m/s <sup>2</sup>	< 2,5	< 2,5	< 2,5
		EN 500-4		
Uncertainty of measurement of the vibration total value a <sub>hV</sub>	m/s <sup>2</sup>	0,5	0,5	0,5
* Depending on the soil properties.				



## 13.4 DPU90r

Designation	Unit	DPU90rLe770 US
Centrifugal force	kN	90
Oscillations	Hz	56
	1/min	3.780
Compaction performance	m <sup>2</sup> /h	1.294
Travel speed*	m/min	28
Gradeability	%	34
Length (center pole in working position)	mm	1.207
Width	mm	770
Height	mm	833
Operating weight	kg	724
Ground clearance	mm	830
Electrical load rating	kW	10,7
Nominal speed	1/min	3.350
Maximum range of remote control	m	20
Maximum transmission time of remote control	h	8
Recommended battery type		Ni-MH 7.2 V/2000 mAh
Battery charging time	h	2
Working pressure of hydraulics	bar	148
Maximum allowable hydraulic pressure	bar	230
Coolant volume	l	3,8
Type of coolant		SAE J1034:Wasser (1:1)
Exciter oil volume	l	1,6
Exciter oil type		M 75W90
Hydraulic oil volume	l	17,7
Type of hydraulic oil		MR 520
Storage temperature range	°C	-20 - +50
Operating temperature range	°C	-10 – +50
Sound pressure level At location of operation L <sub>pA</sub> **	dB(A)	83
Standards		EN 500-4
Sound power level L <sub>wa</sub> measured guaranteed	dB(A)	108
		109
Standards		EN 500-4, 2000/14/EG
* Depending on the soil properties.		
** Measured at 5 m distance (remote controlled machine).		



**13.5 DPU110**

Designation	Unit	DPU110Le870	DPU110Le970	DPU110Le970 US
Centrifugal force	kN	110	110	110
Oscillations	Hz	60	60	60
	1/min	3,600	3,600	3,600
Compaction performance	m <sup>2</sup> /h	1,566	1,746	1,746
Travel speed*	m/min	30	30	30
Gradeability	%	36	36	36
Length (center pole in working position)	mm	2,409	2,409	2,409
Width	mm	870	970	970
Height	mm	1,541	1,541	1,541
Operating weight	kg	813	830	830
Ground clearance	mm	830	830	830
Electrical load rating	kW	16.0	16.0	13,5
Nominal speed	1/min	2,700	2,700	2,700
Working pressure of hydraulics	bar	193	193	193
Maximum allowable hydraulic pressure	bar	230	230	230
Coolant volume	l	4.2	4.2	4.2
Type of coolant		SAE J1034: water (1:1)	SAE J1034: water (1:1)	SAE J1034: water (1:1)
Exciter oil volume	l	1.35	1.35	1.35
Exciter oil type		M 75W90	M 75W90	M 75W90
Hydraulic oil volume	l	21.9	21.9	21.9
Type of hydraulic oil		MR 520	MR 520	MR 520
Storage temperature range	°C	-20 – +50	-20 – +50	-20 – +50
Operating temperature range	°C	-10 – +50	-10 – +50	-10 – +50
Sound pressure level At location of operation L <sub>pA</sub>	dB(A)	94	94	94
Standards		EN 500-4		
Sound power level L <sub>wa</sub> measured guaranteed	dB(A)	108 109	108 109	108 109
Standards		EN 500-4, 2000/14/EG		
Vibration total value a <sub>nv</sub>	m/s <sup>2</sup>	< 2.5	< 2.5	< 2.5
Standards		EN 500-4		
Uncertainty of measurement of the vibration total value a <sub>nv</sub>	m/s <sup>2</sup>	0.5	0.5	0.5
* Depending on the soil properties.				

## 13.6 DPU110r

Designation	Unit	DPU110rLe870	DPU110rLe970
Centrifugal force	kN	110	110
Oscillations	Hz	60	60
	1/min	3,600	3,600
Compaction performance	m <sup>2</sup> /h	1,462	1,630
Travel speed*	m/min	28	28
Gradeability	%	32	32
Length (center pole in working position)	mm	1,207	1,207
Width	mm	870	970
Height	mm	833	833
Operating weight	kg	793	810
Ground clearance	mm	830	830
Electrical load rating	kW	16.0	16.0
Nominal speed	1/min	2,700	2,700
Maximum range of remote control	m	20	20
Maximum transmission time of remote control	h	8	8
Recommended battery type		Ni-MH 7.2 V/2000 mAh	Ni-MH 7.2 V/2000 mAh
Battery charging time	h	2	2
Working pressure of hydraulics	bar	193	193
Maximum allowable hydraulic pressure	bar	230	230
Coolant volume	l	4.2	4.2
Type of coolant		SAE J1034: water (1:1)	SAE J1034: water (1:1)
Exciter oil volume	l	1.6	1.6
Exciter oil type		M 75W90	M 75W90
Hydraulic oil volume	l	21.9	21.9
Type of hydraulic oil		MR 520	MR 520
Storage temperature range	°C	-20 – +50	-20 – +50
Operating temperature range	°C	-10 – +50	-10 – +50
Sound pressure level At location of operation L <sub>pA</sub> **	dB(A)	89	89
Standards		EN 500-4	
Sound power level L <sub>wa</sub> measured guaranteed	dB(A)	108	108
		109	109
Standards		EN 500-4, 2000/14/EG	
* Depending on the soil properties.			
** Measured at 5 m distance (remote controlled machine).			

**13.7 Combustion engine**

Designation	Unit	DPU80	DPU90	DPU110
Manufacturer		Kohler		
Type of engine		KDW 702	KDW 702-3350	KDW 1003
Combustion method		Four-cycle	Four-cycle	Four-cycle
Cooling		Water cooling	Water cooling	Water cooling
Cylinders		2	2	3
Displacement	cm <sup>3</sup>	686	686	1,028
Max. slanting position	°	25	25	25
Fuel type		Diesel	Diesel	Diesel
Fuel consumption	l/h	2.7	2.7	3.3
Tank capacity	l	7.2	7.2	11.2
Oil specification		SAE 10W40	SAE 10W40	SAE 10W40
Max. oil filling	l	1.6	1.6	2.4
Max. performance	kW	11.5	11.7	18.5
Speed	1/min	3,600	3,600	3,600
Standards		ISO 3046-1 IFN		
Air cleaner		Dry-type air cleaner	Dry-type air cleaner	Dry-type air cleaner
Starter type		Electric starter	Electric starter	Electric starter
Voltage of starter battery	V	12	12	12
Battery capacity (nominal value)	Ah	50	50	50

### 13.8 US combustion engine

Designation	Unit	DPU90 US	DPU110 US
Manufacturer		Kohler	
Type of engine		KDW 702-3350 US	KDW 1003 US
Combustion method		Four-cycle	Four-cycle
Cooling		Water cooling	Water cooling
Cylinders		2	3
Displacement	cm <sup>3</sup>	686	1,028
Max. slanting position	°	25	25
Fuel type		Diesel	Diesel
Fuel consumption	l/h	2,7	3.3
Tank capacity	l	7,2	11.2
Oil specification		SAE 10W40	SAE 10W40
Max. oil filling	l	1,6	2.4
Max. performance	kW	11,7	18.5
Speed	1/min	3.600	3,600
Standards		ISO 3046-1 IFN	ISO 3046-1 IFN
Air cleaner		Dry-type air cleaner	Dry-type air cleaner
Starter type		Electric starter	Electric starter
Voltage of starter battery	V	12	12
Battery capacity (nominal value)	Ah	50	50

## **14 Emission control systems information and warranty**

The Emission Control Warranty and associated information is valid only for the U.S.A., its territories, and Canada.

### **Emission control systems warranty statement**

See the *engine owner's manual* for the applicable exhaust and evaporative emission warranty statement.



## EC declaration of conformity

### Manufacturer

Wacker Neuson Produktion GmbH & Co. KG, Preußenstraße 41, 80809 München

This declaration of conformity is issued under the sole responsibility of the manufacturer.

### Product

Product	DPU80Le	DPU90Le	DPU110Le
Product type	Vibratory plate		
Function of product	Soil compaction		
Item number	5100016604		
	5100024695, 5100018444, 5100026787, 5100027032	5100027534, 5100027536, 5100024731	5100018445, 5100024696, 5100026869, 5100027035
Net installed power	11.0 kW	11,7 kW	16.0 kW
Measured sound power level	108 dB(A)	108 dB(A)	108 dB(A)
Guaranteed sound power level	109 dB(A)	109 dB(A)	109 dB(A)

### Conformity assessment procedure

According to 2000/14/EC (2006-06), enclosure VIII.

### Appointed body

VDE Testing and Certification Institute GmbH, Merianstrasse 28, 63069 Offenbach/Main (NB 0366).

### Guidelines and standards

We hereby declare that this product complies with the relevant provisions and requirements of the following guidelines and standards:

2006/42/EC (2009-10), 2000/14/EC (2006-06), EN 500-1 (2009-12), EN 500-4 (2011-02)

### Person responsible for technical documents

Robert Rättsel,  
Wacker Neuson Produktion GmbH & Co. KG, Preußenstraße 41, 80809 München

München, 01.06.2016

Helmut Bauer  
Managing Director



## EC declaration of conformity

### Manufacturer

Wacker Neuson Produktion GmbH & Co. KG, Preußenstraße 41, 80809 München

This declaration of conformity is issued under the sole responsibility of the manufacturer.

### Product

Product	DPU80rLe	DPU110rLe
Product type	Vibratory plate	
Function of product	Soil compaction	
Item number	5100016604	
	5100024697, 5100024698, 5100027033, 5100027034	5100024699, 5100026697, 5100027036, 5100027077
Net installed power	11.0 kW	16.0 kW
Measured sound power level	108 dB(A)	108 dB(A)
Guaranteed sound power level	109 dB(A)	109 dB(A)

### Conformity assessment procedure

According to 2000/14/EC (2006-06), enclosure VIII.

### Appointed body

VDE Testing and Certification Institute GmbH, Merianstrasse 28, 63069 Offenbach/Main (NB 0366).

### Guidelines and standards

We hereby declare that this product complies with the relevant provisions and requirements of the following guidelines and standards:

2006/42/EC (2009-10), 2000/14/EC (2006-06), 2014/30/EU (2014-02), EN 500-1 (2009-12), EN 500-4 (2011-02), EN 13309 (2010-12)

### Person responsible for technical documents

Robert Rätthsel,  
Wacker Neuson Produktion GmbH & Co. KG, Preußenstraße 41, 80809 München

München, 15.02.2016

Helmut Bauer  
Managing Director

