

World's Best Drywall Lifts™

Genuine **PANELLIFT** *USA*

by **Telpro Inc.**
www.telproinc.com

Brand®

Covered by one or more of the following patents: 3,828,942 5,368,429 5,586,619 5,984,605 7,556,464 7,726,901 7,828,506 7,726,901 Other patents pending.

OPERATOR'S MANUAL

For Model 138-2



⚠️ WARNING ⚠️

Read and become familiar with this manual BEFORE operating unit.

Before operating this equipment, thoroughly read this set of instructions, make sure you understand them, and only then follow the step-by-step directions. Failure to do so could result in serious property damage and / or serious bodily injury.

To our valued customer,

Thank you for choosing a **Telpro Inc.**® product by **PARAGON PRO** Manufacturing Solutions. We are pleased that we are able to provide equipment to make your work easier.

Our efforts are focused on producing the finest quality equipment of which we are capable. We make sure to spend extra time and effort on our design and production in order to reduce your time and effort spent using the product.

We take pride in providing the best for our customers. Quality, innovation, and excellence are all qualities this company ensures. No product is sent without being factory tested and inspected to ensure the highest quality for you.

It all began in 1972 when Roland Young designed our first product, the PANELLIFT® Brand Drywall Lift, and revolutionized the drywall industry. To this day we are continuously making advancements in manufacturing and design.

Thank you again for giving us the opportunity to work with you. Any questions or comments that you have are always welcome.

PARAGON PRO
M a n u f a c t u r i n g S o l u t i o n s

CONTENTS

Warning / Instructional Information	Pages 1
User Components & Product Specifications	Page 2
Care & Maintenance	Page 3
Assembly	Pages 4-5
Operation	Page 6
Disassembly	Pages 7-8
Parts Index	Pages 9-10
ASME Standards for Wire Rope	Page 11
Cable Replacement Procedure	Pages 12-16
Extended Telescoping Section Installation Procedure	Pages 17-18
Safety Information	Page 20

⚠ Warning ⚠

Read and follow these warnings and the instructions that follow. Failure to do so could result in serious property damage and/or serious bodily injury.

• **BEFORE** operating this equipment, thoroughly read this set of instructions, make sure you understand them, and only then follow the step-by-step directions. **FAILURE TO READ AND FOLLOW THESE INSTRUCTIONS** could result in failure of the equipment. Failure of the equipment while the lift is raised can include a sudden and rapid lowering of the lift and load possibly resulting in serious property damage and/or serious bodily injury.

• Use and maintenance of the PANELLIFT® Drywall Lift shall be limited to authorized personnel who are trained in the proper techniques for its safe operation and maintenance and who are familiar with the various hazards of overhead material handling.

• It shall be the responsibility of the owner of the PANELLIFT® Drywall Lift to keep the product properly maintained.

• As with any lifting equipment, **ALWAYS WEAR A HARD HAT** when operating the PANELLIFT® Drywall Lift. Failure to do so could result in serious bodily injury.

• **DO NOT ATTEMPT TO USE YOUR PANELLIFT® Drywall Lift IF ANY PART IS MISSING, DAMAGED OR WORN. ORDER A REPLACEMENT PART IMMEDIATELY.** Using a PANELLIFT® Drywall Lift with missing, damaged or worn components can result in failure of the unit and possibly severe property damage and/or serious bodily injury.

• **INSPECT THE CABLE BEFORE EACH USE. REPLACE AT THE FIRST SIGN OF WEAR.** A worn, damaged or improperly installed cable can fail resulting in a sudden and rapid lowering of the lift and the load and possibly resulting in serious property damage and/or serious bodily injury. Inspect the cable by disassembling the telescoping system as shown in steps 1-3 on page 13 of this manual and examine the full length of the cable for signs of damage or wear. Reassemble and replace the telescoping sections according to steps 9-13 on pages 15-16 of this manual.

(See page 11 for general standards for cable inspection.)

• **The weight capacity of the PANELLIFT® Drywall Lift is 150 lbs. (68 kg). DO NOT load the unit beyond this limit.**

Load only one sheet of wallboard at a time. Failure to follow this warning can result in damage to the PANELLIFT® Drywall Lift contributing to a sudden failure of the machine and serious property damage and/or serious bodily injury.

• **DO NOT ROLL** a loaded PANELLIFT® Drywall Lift while the load is raised. Always keep the load lowered until the lift is in place beneath the space in which the loaded wallboard will be installed. Rolling a PANELLIFT® Drywall Lift while the load is raised can result in tipping the lift and load possibly resulting in serious property damage and/or serious bodily injury.

• Operate the PANELLIFT® Drywall Lift only on hard, flat, level surfaces free of obstructions, debris, clutter, pits, holes or openings. Failure to follow this warning can result in tipping the lift and load possibly resulting in serious property damage and/or serious bodily injury.

• The PANELLIFT® Drywall Lift is designed exclusively as a material lift and shall be used for no other purpose. The PANELLIFT® Drywall Lift is not a personnel lift or platform and shall not be used as such. Using the PANELLIFT® Drywall Lift for purposes other than a material lift can subject the unit to stresses and loads that it was not designed to carry. This can result in failure of the unit which may include a sudden and rapid lowering of the lift and the load possibly resulting in serious property damage and/or serious bodily injury.

• The PANELLIFT® Drywall Lift is made of steel which conducts electricity. **KEEP THE UNIT AWAY FROM LIVE ELECTRICAL WIRES.** Failure to do so could result in electrocution.

• Use only factory authorized replacement parts. Installation of other parts can compromise the safe design of the PANELLIFT® Drywall Lift and may cause failure of the unit possibly resulting in serious property damage and/or serious bodily injury. Use of non-factory authorized replacement parts will void all warranties.

• Moving the PANELLIFT® Drywall Lift from a cold environment to a warm one may cause condensation to form on metal surfaces creating a potential for malfunction. Such malfunction could possibly result in serious property damage and/or serious bodily injury: Allow the unit to reach working room temperature and check to make sure that the winch brake drum is clean and dry before operating.

• **DO NOT** pass your hand through the spokes on the winch when operating the unit as this could result in serious bodily injury.

USER COMPONENTS & SPECIFICATIONS

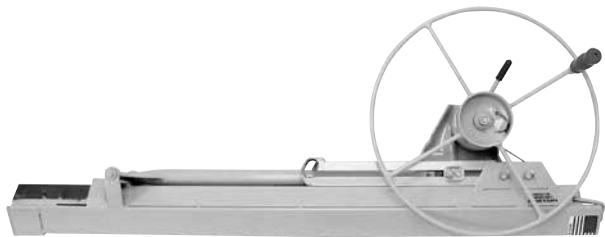

A. Complete frame assembly with winch and standard telescoping sections



B. Cradle assembly - less detachable cross arms



C. Cradle cross arms (1 pair)



D. Complete tripod base assembly

SHEET QUANTITY CAPACITY

Single

LOAD RATING

150 lbs. (68 kg) **DO NOT EXCEED.**

MAXIMUM HEIGHT

11' (335 cm)
15' (457 cm) w/ optional extension

LOADING HEIGHT

34" (86 cm)

NET WEIGHT

Approximately 100 lbs. (45 kg)

*DESIGNED FOR OPERATION ON HARD, LEVEL SURFACE AT ROOM TEMPERATURE
IN A DRY ENVIRONMENT **AVOID MOISTURE AND WATER***

SEE PAGES 1, 3 & 9 FOR IMPORTANT OPERATIONAL WARNINGS

CARE AND MAINTENANCE

- Inspect cable FREQUENTLY.
(At least daily and before each use) Replace at the first sign of wear. (See Warnings on pages 1 & 9)
- Occasionally oil the cable sheaves and caster bearings.
- Store the Panellift® Drywall Lift in a dry place.
- Do not allow grease or oil to contact the surface of the winch brake drum. (Powdered gypsum applied to the brake will help dry the surface.
- Apply household paraffin to the surfaces of the telescoping sections, for smoother action.
- Take reasonable care to avoid damaging the PANELLIFT® Drywall Lift when transporting it.
- Do not hammer on any members or components of the PANELLIFT® Drywall Lift.

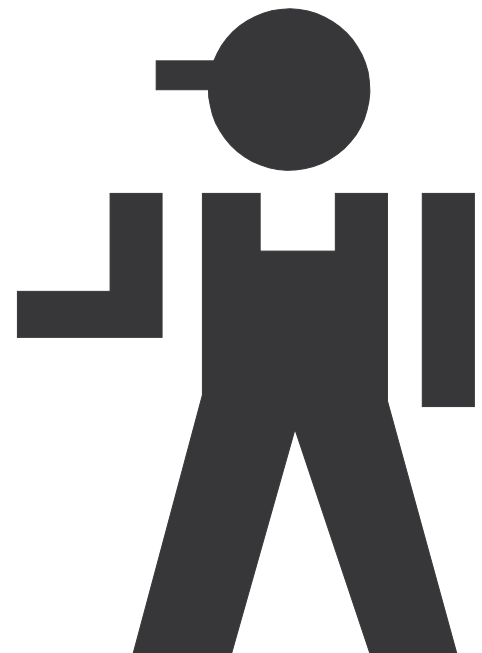

ASSEMBLY



1. Begin by setting up the tripod base: press down on the slide yoke pin clip and swing the outer legs out until they lock in the working position (note the holes on the bottom of the slide tube).



2C. To hold the tripod base in position during this procedure set the backstop as shown.



2A. Place the frame assembly on the tripod base.



2D. When the frame is correctly positioned on the tripod base release the backstop.

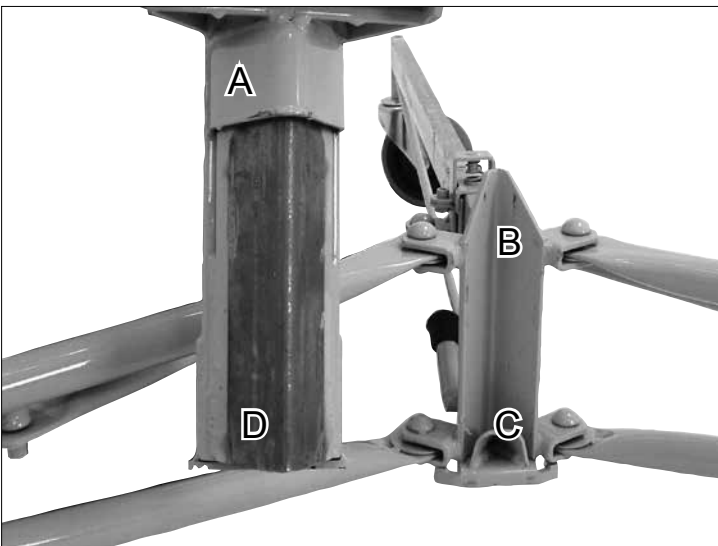

2B. Pocket "A" slides OVER angle "B" while angle "C" slides INSIDE angle "D".

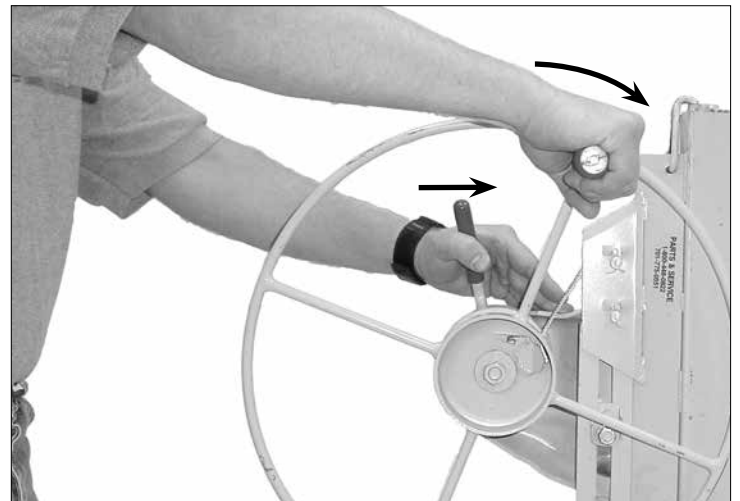

3. To move the winch into the working position rotate the winch forward slightly with your right hand while raising the brake arm with your left hand.

ASSEMBLY continued

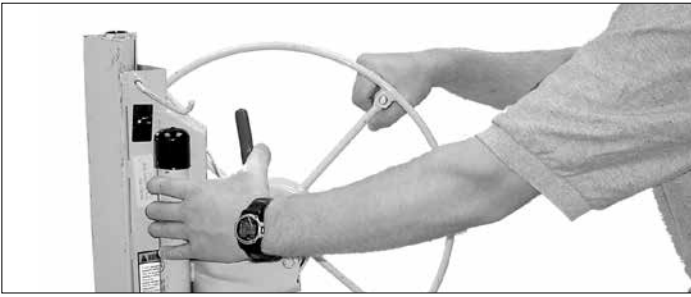

4. Raise the brake arm all the way up, grasp the winch post, and squeeze the brake arm firmly as shown.

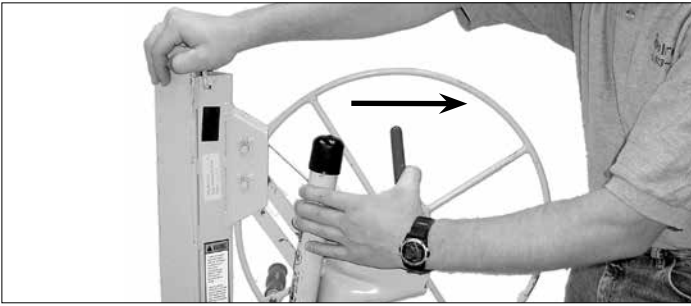

5. Place your right hand on top of the frame and pull the winch assembly towards you. While pulling the winch towards you, grip the brake arm sufficiently to prevent back-lash of the cable on the winch.

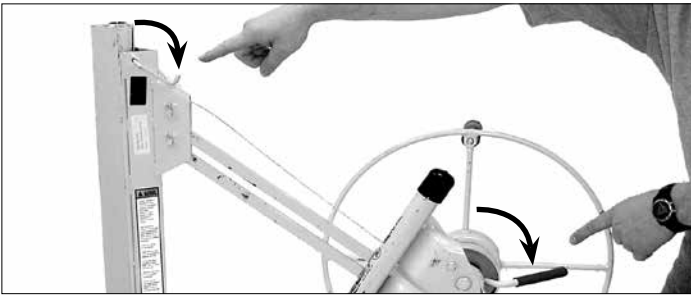

6. When the winch is fully extended, release the brake arm and swing the retaining hook away from the telescoping sections.



7. Now push the winch assembly back towards the frame. This action will automatically engage the slide bar lock. ALWAYS check to make sure that the slide bar lock is fully engaged by rotating it clockwise as far as possible before proceeding. The illustration shows a fully engaged slide bar lock. NOTE: DO NOT tighten the slide bar lock nut assembly. This will make it impossible to collapse the PANELLIFT® properly for transport and storage.



8. Mount the cradle on top of the telescoping section. Flip out the tilt latch to allow the cradle to tilt for loading and for hanging drywall on sidewalls and sloped ceilings.



9. Place the tapered plates of the cross arms into the tapered sockets on the cradle. The spring tab on the back of the cross arm will lock it into place.

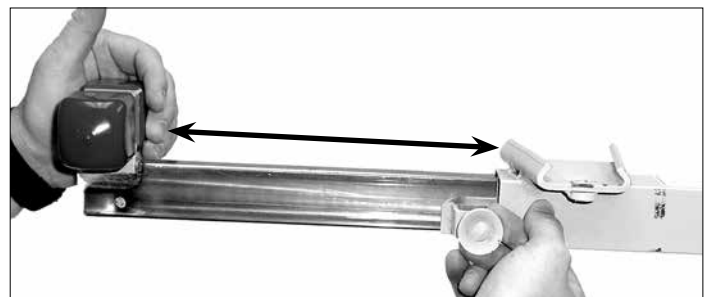

10. To extend the outriggers for use, pull out on the outrigger lock pin with your right hand and slide the outrigger out with your left hand as shown. The lock pin will engage at three different points on the outrigger: fully retracted, extended 21", or extended 33". MAKE SURE that the lock pins are engaged in one of these three positions before loading the unit. DO NOT use the PANELLIFT® with the outriggers extended beyond the 33" point. Retract the outriggers when storing or transporting the unit.

OPERATION



When the backstop legs are set, they keep the unit from shifting while loading wallboard or while installing the frame on the tripod base.



1. To Load: Set the backstop on the tripod base to hold the unit in position. Extend the cradle outriggers to properly support the drywall, tilt the cradle, and swing out the cross arm support hooks. Load the PANELLIFT® Drywall Lift from the front as shown with the face paper of the drywall contacting the cradle. (Note: the optional loader attachment shown on page 29 makes this process even easier.)

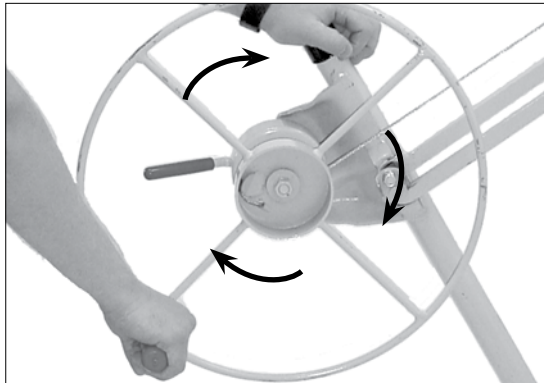

2. To raise the PANELLIFT® Drywall Lift rotate the winch wheel in the direction shown. The brake arm is spring loaded to hold the winch automatically at any height.

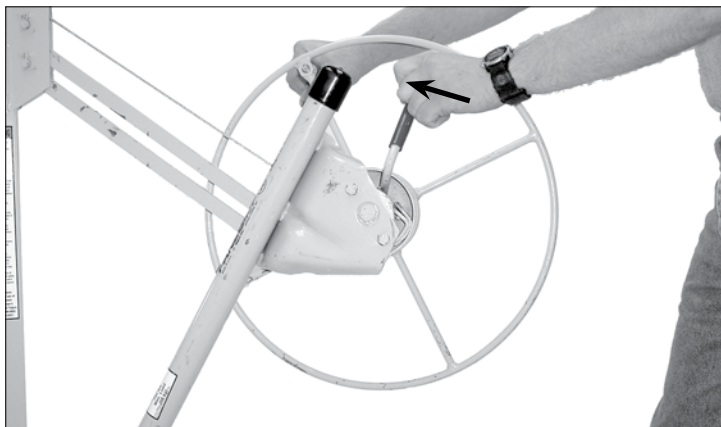

3. To lower the PANELLIFT® Drywall Lift control the backward rotation of the winch by grasping the winch handle with your right hand BEFORE releasing the brake with your left hand. ALWAYS use this two hand method when lowering the PANELLIFT® Drywall Lift.

4. The PANELLIFT® Drywall Lift will hold drywall in position on sidewalls and sloped ceilings in addition to level ceilings. The cradle also tilts up to 10° longitudinally.

USE THE BACKSTOP ON THE TRIPOD BASE WHEN WORKING ON SIDEWALLS AND SLOPED CEILINGS.

When working on sloped ceilings, start at the peak and work down.



▲ WARNING ▲

DO NOT ROLL
a loaded PANELLIFT® Drywall Lift while the load is raised. Always keep the load lowered until the lift is in place beneath the space in which the loaded wallboard will be installed.

Rolling a PANELLIFT® Drywall Lift while the load is raised can result in tipping the lift and load possibly resulting in serious property damage and/or serious bodily injury.

DISASSEMBLY

Disassemble the PANELLIFT® Drywall Lift as follows for transport and compact storage.

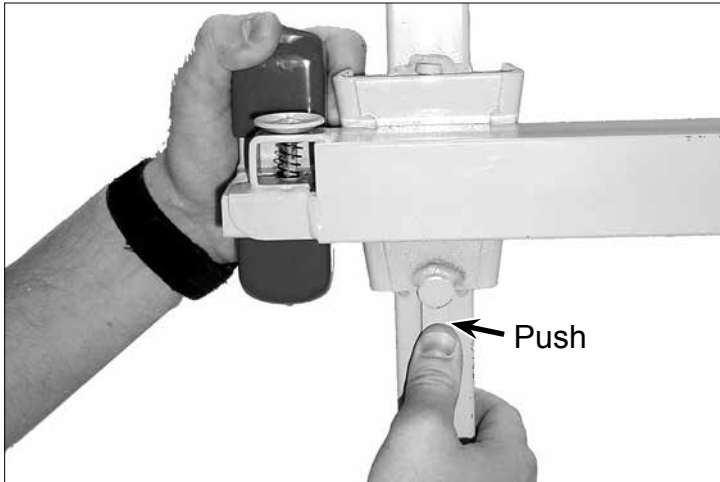

1. Slide the cradle outriggers all the way in.
2. Remove the cross arms by pressing the spring tab on the bottom and sliding the cross arm out of the tapered socket.

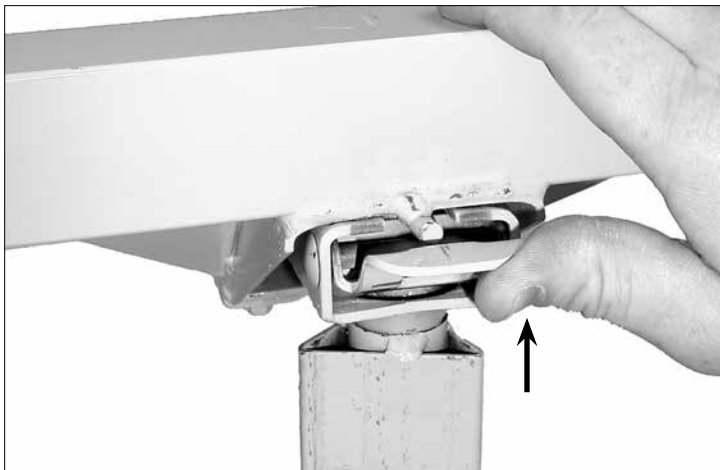

3. Lock the cradle tilt latch and lift the cradle off of the frame.

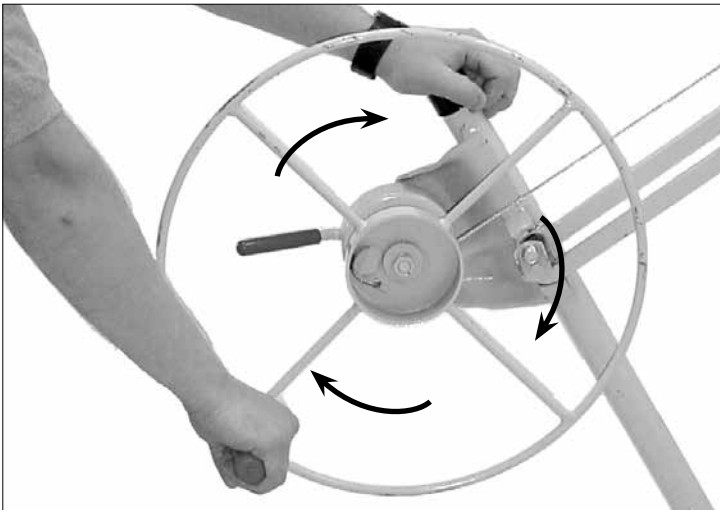

4. Rotate the winch forward one full rotation.

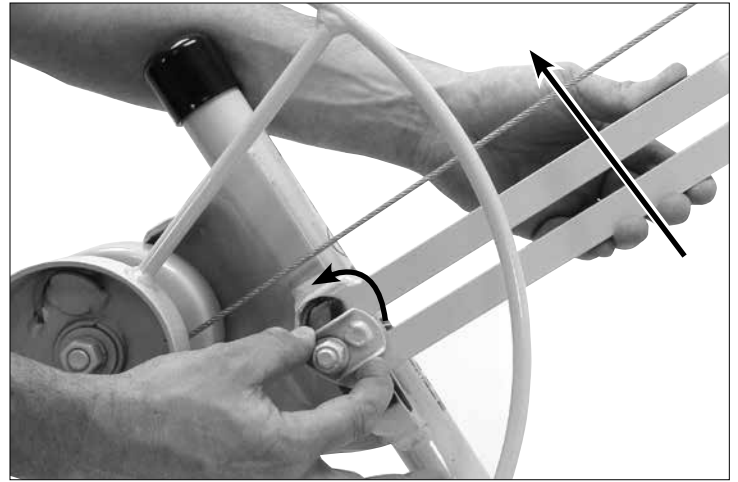

5. Raise up on the slide bar with your left hand while rotating the slide bar lock counter-clockwise with your right hand.

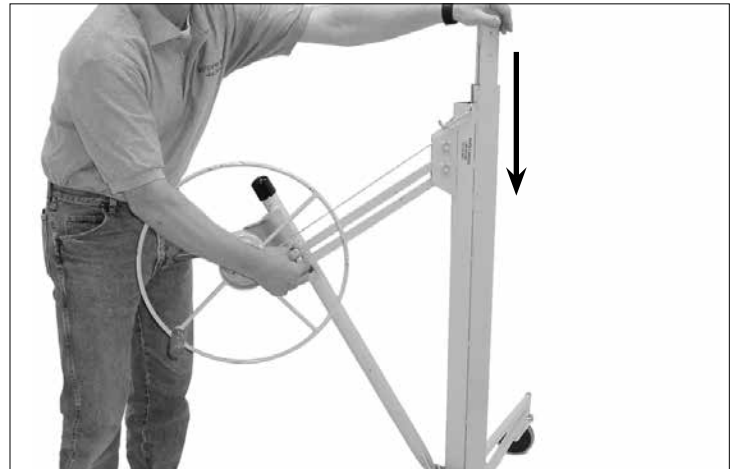

6. While holding the slide bar lock in this disengaged position with your right hand, push down on top of the telescoping section with your left hand. This action will cause the winch assembly to move toward the frame.



7. With the telescoping section all the way down, position the retaining hook over the top as shown.

DISASSEMBLY continued



8. Hold the retaining hook in this position with your left hand and rotate the winch forward with your right hand. This will cause the winch assembly to fold up against the frame. When the slide bar contacts the frame, tighten the cable just sufficiently to hold the winch in the collapsed position.



9. Lift the frame off of the tripod base.



10. To collapse the tripod base, press down on the slide yoke pin clip and swing the legs in until they lock in the closed position.

PARTS INDEX Model 138-2

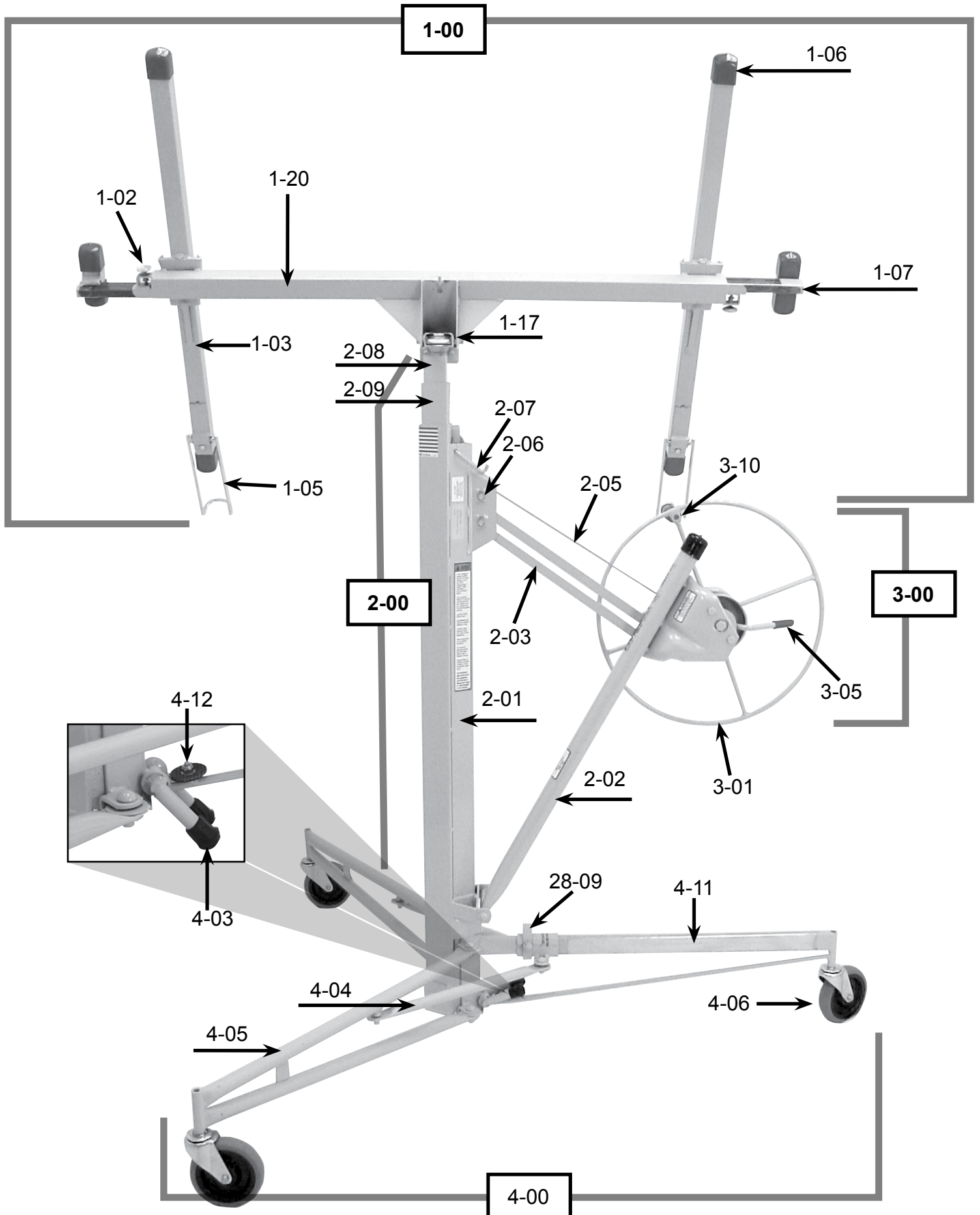

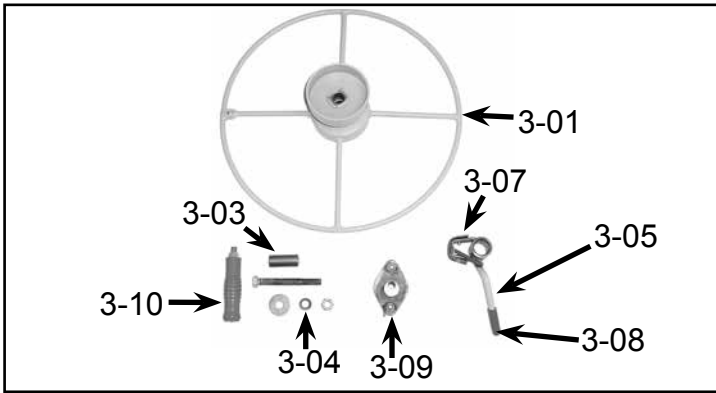

Winch Components

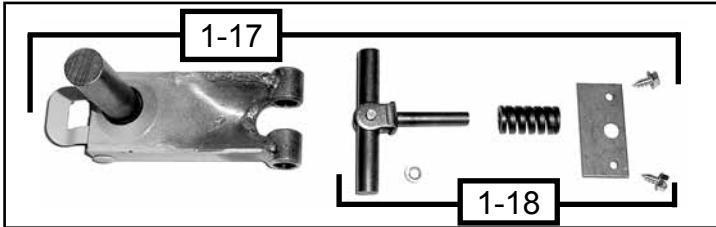

Mounting head components

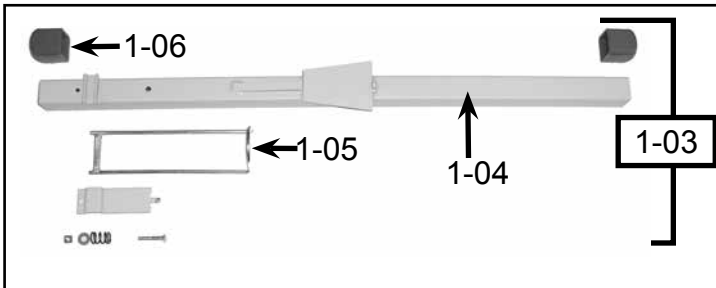

Cross arm components

CRADLE UNIT

Part	Description
1-00	Complete cradle assembly
1-02	Pull pin with fasteners
1-03	Complete cross arm assembly
1-04	Cross arm body
1-05	Support hook with fasteners
1-06	End caps (set of 8)
1-07	Outrigger with end cap
1-17	Complete mounting head assembly
1-18	Complete spring yoke pin assembly
1-20	Cradle Body

FRAME UNIT

Part	Description
2-00	Complete frame assembly with winch and standard "A" and "B" sections
2-01	Frame housing
2-02	Winch post with pin and fasteners
2-03	Slide bar with pins
2-04	Slide bar lock with fasteners
2-05	Cable 13.5' 1/8" aircraft
2-06	Cable sheave with axle and pins
2-07	Retaining hook
2-08	4' "A" section (inner)
2-09	4' "B" section with sheaves

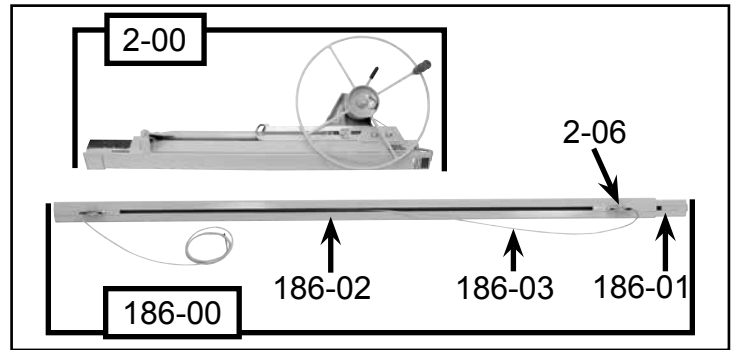

Optional Extension Unit 186-00

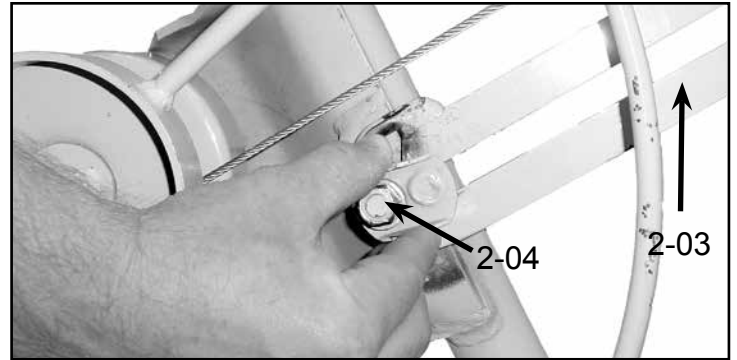

WINCH UNIT

Part	Description
3-00	Complete winch assembly
3-01	Winch wheel with bronze flange bearings
3-03	7/8" bushing
3-04	1/2" bolt with washer and nut
3-05	Complete brake arm assembly
3-07	Tension spring "B"
3-08	Brake handle cover
3-09	Brake hub with bolts
3-10	Winch handle

TRIPOD BASE UNIT

Part	Description
4-00	Complete tripod base assembly
4-03	Backstop tip
4-04	Tie arm with fasteners
4-05	Outer leg w/ fasteners
4-06	Caster 5"
4-11	Center leg
4-12	Backstop Fiber Washer w/ Fasteners
28-09	Slide Yoke Pin Clip w/ Fasteners

186-00 EXTENSION UNIT FOR CEILINGS OR WALLS UP TO 15'

Part	Description
186-00	Complete extension unit
186-01	6' "E" section (inner)
186-02	6' "F" section with sheaves
186-03	Cable 17 1/3' 1/8" aircraft

ASME Standards for wire rope (cable) inspection and replacement

Reprinted with permission from ASME B30.19 Cableways

The following is intended as a helpful guide to the general topic of inspection and replacement of wire rope (cable). It is not intended to be an exhaustive treatment of the topic.

Frequent inspection (at least daily) by a competent person and prompt replacement of any cable that shows any sign of wear is the responsibility of the owner and the operator of the PANELLIFT® Drywall Lift.

With reference to the chart below at 19-2.4.3(b)(6) the Panellift® Drywall Lift cable is a nominal 1/8" high tensile cable (rope).

(00) General

The use of cableways, cranes, derricks, hoists, hooks, jacks, and slings is subject to certain hazards that cannot be met by mechanical means but only by the exercise of intelligence, care, and common sense. It is therefore essential to have personnel involved in the use and operation of equipment who are competent, careful, physically and mentally qualified, and trained in the safe operation of the equipment and the handling of the loads. Serious hazards are overloading, dropping or slipping of the load caused by improper hitching or slinging, obstructing the free passage of the load, and using equipment for a purpose for which it was not intended or designed.

Section 19-2.4: Rope Inspection, Replacement, and Maintenance

19-2.4.1 General. Sheave diameters, drum diameters, and rope design factors are limited because of cableway design configuration. Due to these parameters, inspection in accordance with para. 19-2.4.2 to detect deterioration and timely replacement in accordance with para. 19-2.4.3 are essential.

19-2.4.2 Inspection

(a) Frequent Inspection

(1) All running ropes in service should be visually inspected once each working day. A visual inspection shall consist of observation of all rope that can reasonably be expected to be in use during the day's operations. These visual observations should be concerned with discovering gross damage that may be an immediate hazard, such as listed below:

(a) distortion of the rope such as kinking, crushing, unstranding, birdcaging, main strand displacement, or core protrusion. Loss of rope diameter in a short rope length or unevenness of outer strands should provide evidence that the rope or ropes are to be replaced.

(b) general corrosion;

(c) broken or cut strands;

(d) number, distribution, and type of visible broken wires [see paras. 19-2.4.3(b)(1), (2), and (7) for further guidance];

(e) core failure in rotation-resistant ropes; when damage is suspected, the rope shall either be removed from service or given an inspection as detailed in para. 19-2.4.2(b).

(2) Care shall be taken when inspecting sections of rapid deterioration, such as flange points, crossover points, and repetitive pickup points on drums.

(3) Care shall be taken when inspecting certain ropes, such as rotation-resistant ropes, because of their higher susceptibility to damage and increased deterioration when working on equipment with limited design parameters. The internal deterioration of rotation-resistant ropes may not be readily observable.

(b) Periodic Inspection

(1) The inspection frequency shall be determined by a qualified person and shall be based on such factors as expected rope life (determined by experience on the particular installation or similar installations), severity of environment, percentage of capacity lifts, frequency rates of operation, and exposure to shock loads. Inspections need not be at equal calendar intervals and should be more frequent as the rope approaches the end of its useful life. The inspection shall be made at least every 1000 hr of cableway operation or annually, whichever comes first.

(2) Periodic inspections shall be performed by an appointed or authorized person. This inspection shall cover the entire length of rope. Only the surface wires of the rope need be inspected. No attempt should be made to open the rope. Any deterioration resulting in appreciable loss of original strength, such as described below, shall be noted, and a determination shall be made as to whether further use of the rope would constitute a hazard:

(a) points listed in para. 19-2.4.2(a):

(b) reduction of rope diameter below nominal diameter due to loss of core support, corrosion, or wear of outside wires;

(c) severely corroded or broken wires at end connections;

(d) severely corroded, cracked, bent, worn, or improperly applied end connections.

(3) Care shall be taken when inspecting sections of rapid deterioration, such as the following:

(a) sections in contact with saddles, equalizer sheaves, or other sheaves, including track cable sheaves, where rope travel is limited;

(b) sections of the rope at or near terminal ends where corroded or broken wires may develop.

19-2.4.3 Rope Replacement

(a) No precise rules can be given for determination of the exact time for rope replacement, since many variable factors are involved. Once a rope reaches any one of the specified removal criteria, it may be allowed to operate to the end of the work shift, based on the judgment of a qualified person. The rope shall be replaced after that work shift, at the end of the day, or at the latest time prior to the equipment being used by the next work shift.

(b) Removal criteria for rope replacement shall be as follows:

(1) In running ropes, six randomly distributed broken wires in one lay, or three broken wires in one strand in one lay.

(2) One outer wire, broken at the contact point with the core of the rope, that has worked its way out of the rope structure and protrudes and loops out from the rope structure. Additional inspection of this section is required.

(3) Wear of one-third the original diameter of outside individual wires.

(4) Kinking, crushing, birdcaging, or any other damage resulting in distortion of the rope structure.

(5) Evidence of heat damage from any cause.

(6) Reductions from nominal diameter greater than those shown below:

Rope Diam. _____	Max. Allowable Reduction From Nominal Diam. _____
Up to 5/16 in. (8 mm)	1/64 in. (0.4 mm)
Over 3/8 in. up to 1/2 in. (13 mm)	1/32 in. (0.8 mm)
Over 9/16 in. up to 3/4 in. (19 mm)	3/64 in. (1.2 mm)
Over 7/8 in. up to 1 1/8 in. (29 mm)	1/16 in. (1.6 mm)
Over 1 1/4 in. up to 1 1/2 in. (38 mm)	3/32 in. (2.4 mm)

(7) In standing ropes, more than two broken wires in one lay in sections beyond end connections, or more than one broken wire at an end connection.

(c) Broken wire removal criteria cited in this Volume apply to wire rope operating on steel sheaves and drums. The user shall contact the sheave, drum, or cableway manufacturer, or a qualified person for broken wire removal criteria for wire ropes operating on sheaves and drums made of material other than steel.

(d) Replacement rope shall have a nominal strength rating at least equal to the original rope furnished or recommended by the cableway manufacturer or designer, or a qualified person. Any deviation from the original size, grade, or construction shall be specified by the rope manufacturer, the cableway manufacturer or designer, or a qualified person.

(e) Ropes Not in Regular Use. All rope that has been idle for a period of a month or more due to shutdown or storage of a cableway on which it is installed shall be given an inspection in accordance with para. 19-2.4.2(b) before it is placed in service. This inspection shall be for all types of deterioration and shall be performed by an appointed or authorized person.

(f) Inspection Records

(1) Frequent inspection-no records required.

(2) Periodic inspection - in order to establish data as a basis for judging the proper time for replacement, a dated report of rope condition at each periodic inspection shall be kept on file. This report shall cover points of deterioration listed in para. 19-2.4.2(b)(2).

(g) A long-range inspection program should be established and should include records on examination of rope removed from service so a relationship can be established between visual observation and actual condition of the internal structure.

CABLE REPLACEMENT INSTRUCTIONS

Part No. 02-05 for PANELLIFT® Drywall Lift Model 138-2 and 125
Part No. 186-03 for PANELLIFT® Drywall Lift Extension 186-00 and 186-12

⚠ WARNING ⚠

BEFORE installing this component, thoroughly read this set of instructions, make sure you understand them, and only then follow the step-by-step directions.

FAILURE TO READ AND FOLLOW THESE INSTRUCTIONS could result in failure of the equipment. Failure of the equipment while the lift is raised can include a sudden and rapid lowering of the lift and load possibly resulting in serious property damage and/or serious bodily injury.

BEFORE installing the components described in these instructions, determine the model of PANELLIFT® Brand Drywall Lift into which the components will be installed. **THEN** read and become familiar with the complete Operator's Manual for that model of PANELLIFT® Brand Drywall Lift.

The complete Operator's Manual for the PANELLIFT® Brand Drywall Lift Model 138-2 and 125 is available at www.telproinc.com or call 701-775-0551 to receive a hard copy by mail.

- Use and maintenance of the PANELLIFT® Drywall Lift shall be limited to authorized personnel who are trained in the proper techniques for its safe operation and maintenance and who are familiar with the various hazards of overhead material handling.

- **DO NOT ATTEMPT TO USE YOUR PANELLIFT® Drywall Lift IF ANY PART IS MISSING, DAMAGED OR WORN. ORDER A REPLACEMENT PART IMMEDIATELY.** Using a PANELLIFT® Drywall Lift with missing, damaged or worn components can result in failure of the unit and possibly severe property damage and/or serious bodily injury.

- Inspect the Sheaves (Pulleys) and follow the procedure at the right to replace when worn. Sheave (Pulley) wear can occur where the cable rides and on the axle. Make sure to inspect both. Sheave can either be brass or aluminium. The sheave on the left is badly worn on both the axle and cable groove. Sheave on right is a new sheave.



- Use only factory authorized replacement parts. Installation of other parts can compromise the safe design of the PANELLIFT® Drywall Lift and may cause failure of the unit possibly resulting in serious property damage and/or serious bodily injury.

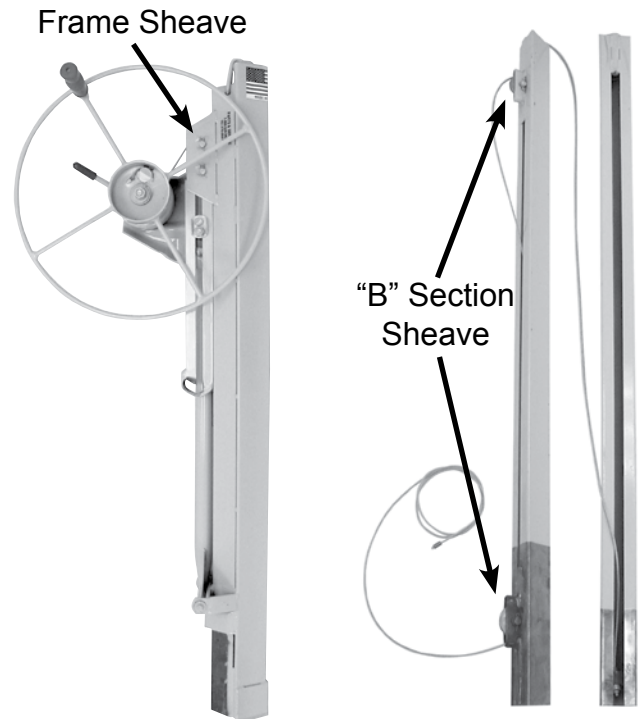

Inspect and replace sheaves (pulleys) before replacing the cable. There are 3 sheaves on the 138-2 Panellift®, one on the frame and two on the "B" telescoping section. Sheaves should be solid on their axle and not move up and down or back and forth. To replace, remove cotter keys and discard old axle and sheave. Replace with new sheave, axle and new cotter keys.

BE SURE that the cable is fed correctly over the roller sheaves according to the following instructions:

Questions? - Call Telpro Inc. Customer Service at 1-800-448-0822 or 701-775-0551

CABLE REPLACEMENT INSTRUCTIONS continued

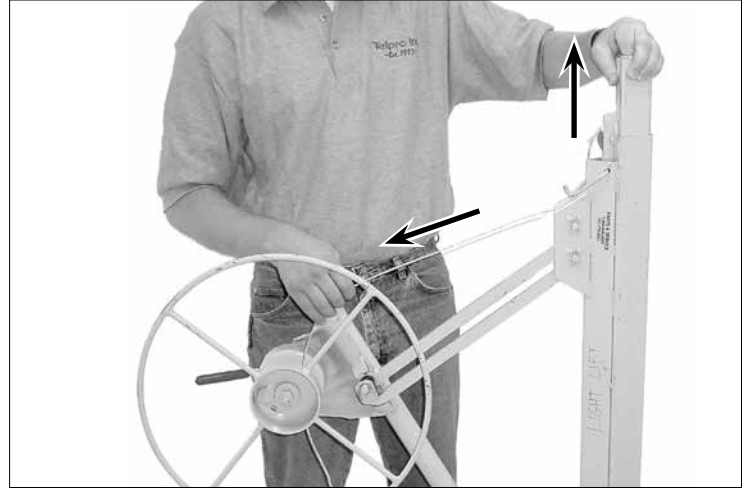
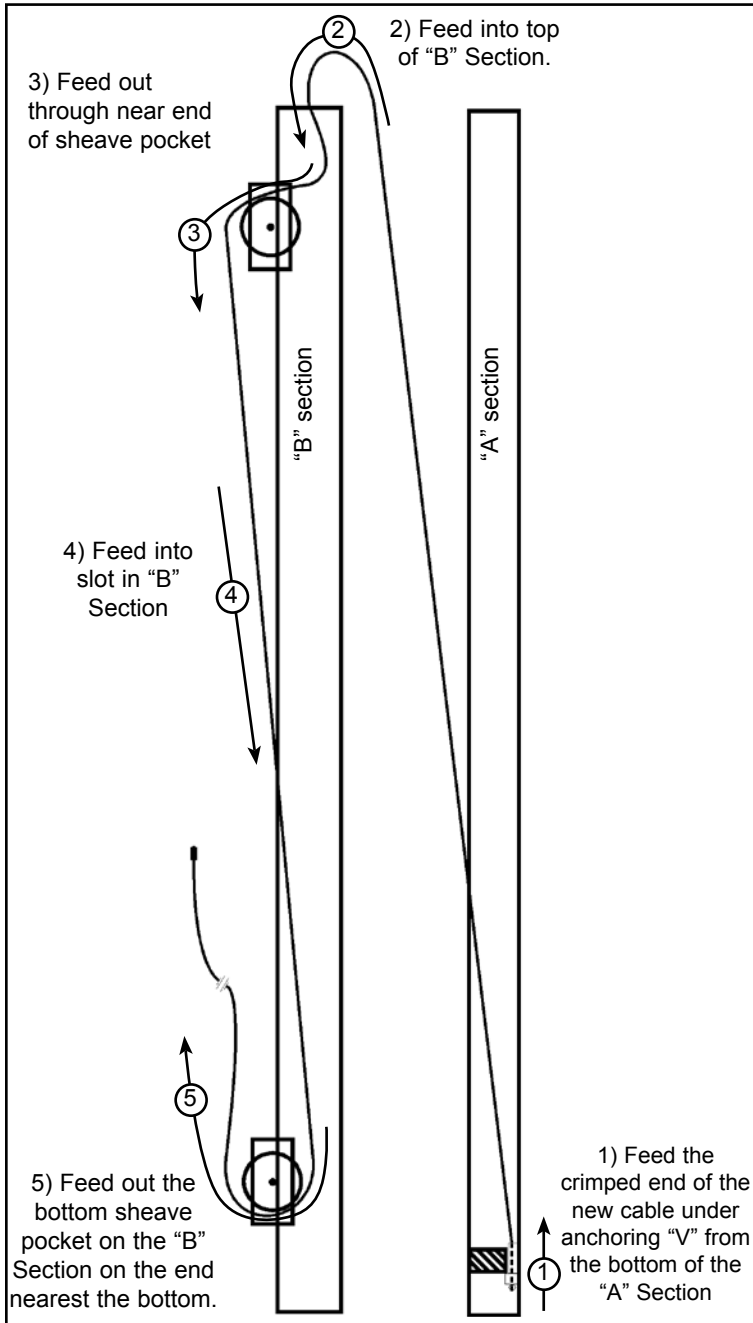

2. Pinch the two telescoping sections together and lift them out as a unit. Pulling the cable will help to raise them.

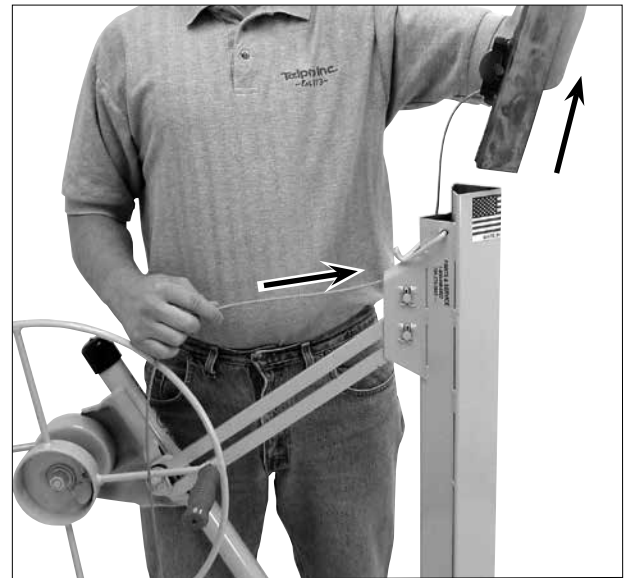

3. Remove the two telescoping sections completely from the frame housing. Pull the cable completely out from the frame along with them. Remove the "A" Section from the "B" Section as shown below. **BE CAREFUL** for loose strands or frays on the cable.

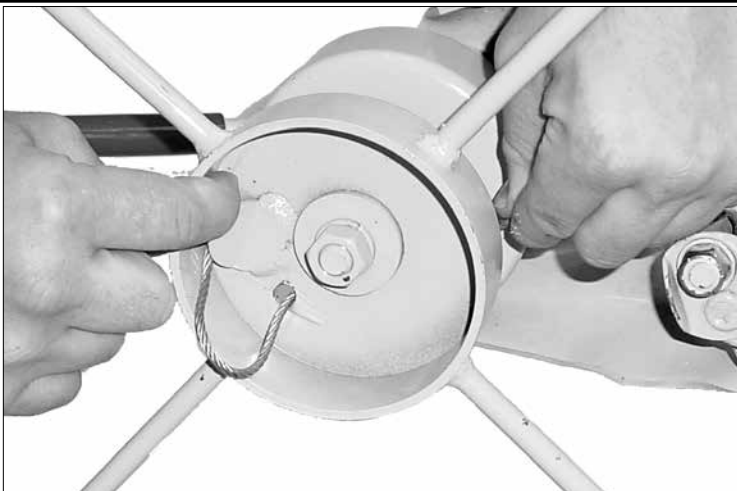
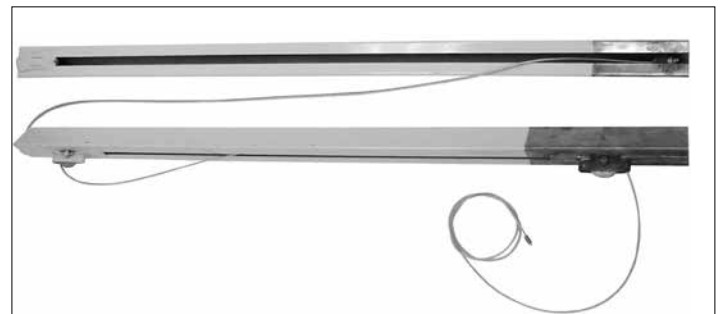

1. Loosen the cable from the mooring tab on the winch and pull it out from the winch drum. **BE CAREFUL!** A worn cable can have frayed strands. Wearing gloves will help protect your hands.

CABLE REPLACEMENT INSTRUCTIONS continued

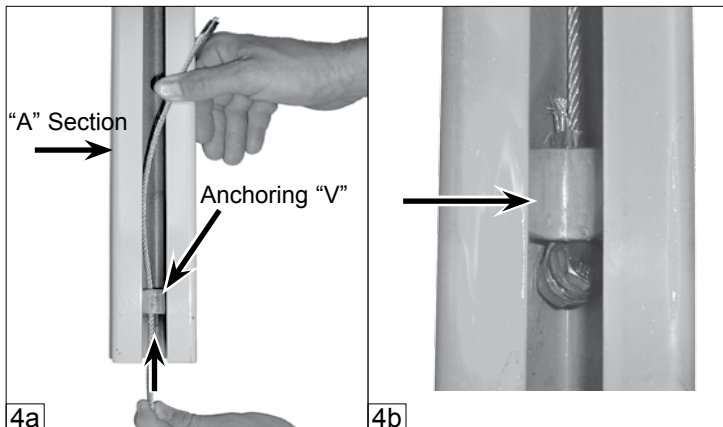

4a. Feed the crimped end of the new cable through the "A" section anchoring "V" from the bottom as shown. 4b. Make sure the anchoring end of the cable is pulled snugly against the anchoring "V" as shown. **(NEVER DISASSEMBLE THE NUT AND BOLT OF CABLE ANCHORING ASSEMBLY)**

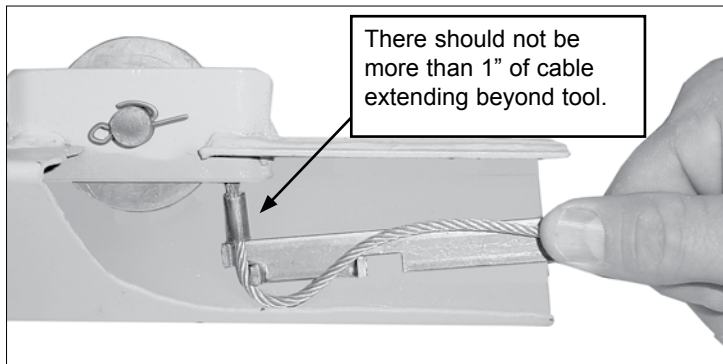

5. Use the special tool provided to insert the crimped end of the cable into the TOP end of the "B" section as shown in this cut away view. If your "B" section is the factory original and not a replacement, the top is the painted end and the bottom has several inches of unfinished surface. If both ends of your "B" section are painted it is either a replacement or you are working on the "F" section of an extension 186-00. In either of these cases wear marks on the section should give you an indication of which end is the top.

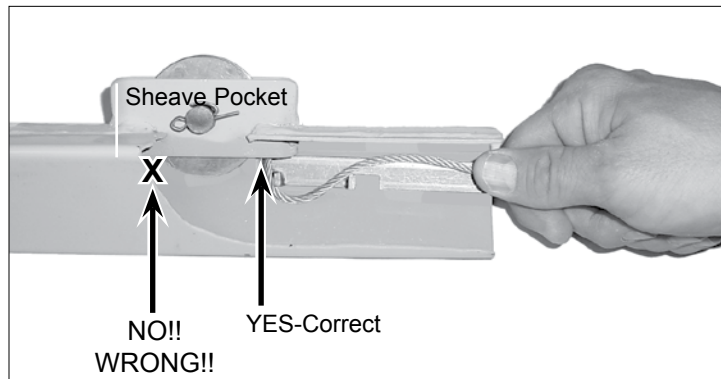

6a. Insert the crimped end of the cable into the sheave pocket at the end nearest the end of the "B" section as shown.

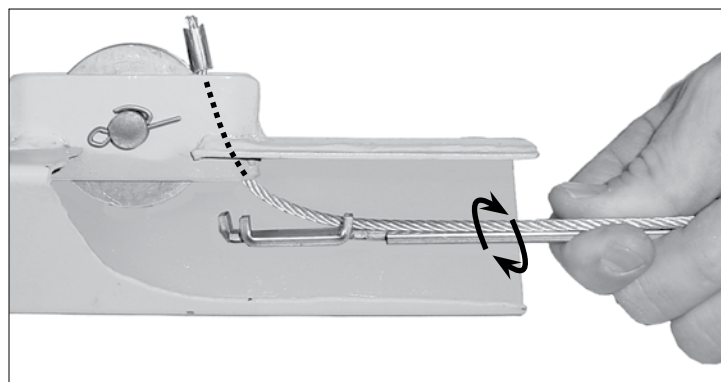

6b. With a clock-wise motion like that of tightening a screw driver, twist the cable installation tool while holding the crimped end of the cable up into the sheave pocket. The cable will pop loose from the tool and pop up through the sheave pocket as shown in this cut away view.

⚠ WARNING ⚠

The cable **MUST** feed in from the top of the "B" exactly as shown in steps 2 - 3 in order to function properly. Failure to install the cable correctly as shown can cause wearing of the cable for which it is not designed which can result in failure of the cable. Failure of the cable while the lift is raised will result in a sudden and rapid lowering of the lift and the load possibly resulting in serious property damage and/or serious bodily injury.

CABLE REPLACEMENT INSTRUCTIONS continued

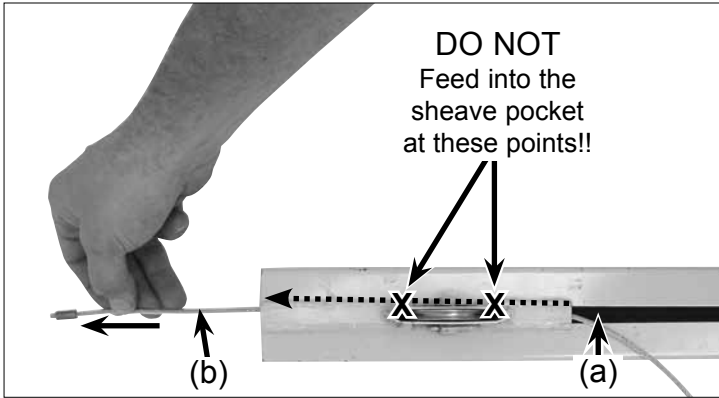

7. Feed the crimped end of the cable down into the slot (a) of the "B" section and out the bottom end of the telescoping section (b) as shown. Pull the cable completely through to remove the slack.

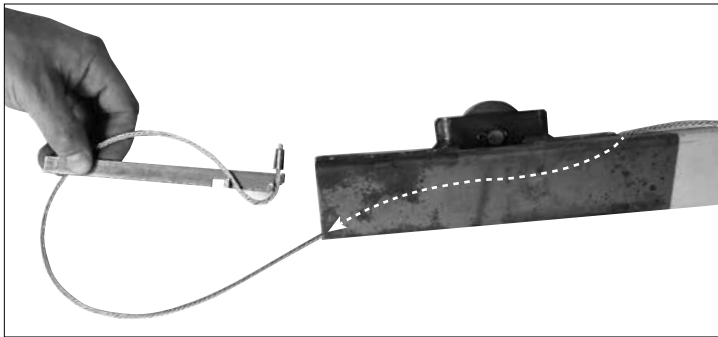

8a. Reload and insert the cable installation tool into the BOTTOM end of the "B" section as shown.

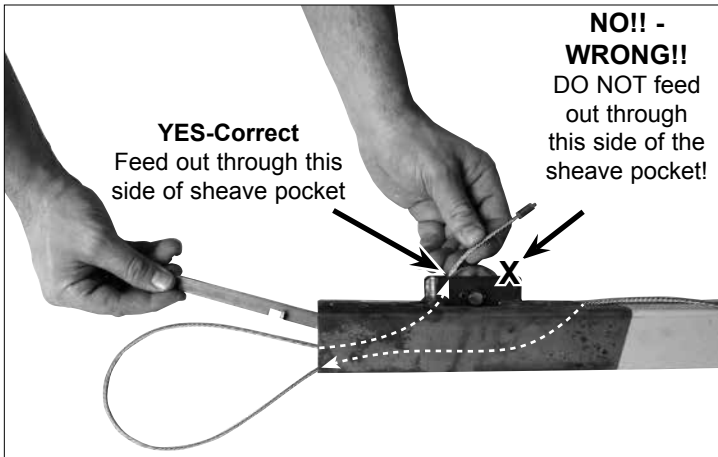

8b. Repeat the process performed in steps 2 - 3: Insert the crimped end of the cable up into the end of the sheave pocket at the end nearest the bottom of the "B" section as traced by the dotted arrows. Twist the installation tool while holding the crimped end of the cable up into the sheave pocket. Pull the crimped end out completely to remove the slack.

⚠ WARNING ⚠

The cable MUST first pass down through the slot and out the bottom, then loop back in from the bottom of the "B" to feed through the sheave pocket exactly as shown in steps 4 - 5 in order to function properly. Failure to install the cable correctly as shown can cause wearing of the cable for which it is not designed which can result in failure of the cable. Failure of the cable while the lift is raised will result in a sudden and rapid lowering of the lift and the load possibly resulting in serious property damage and / or serious bodily injury.

9. A correctly strung cable is shown at right:

Starting through the "A" section anchoring "V" from the bottom (1), into the top of the "B" section (2), back out through the sheave pocket at the end nearest the top of the telescoping section (3), into the slot of the "B" section (4), and out a final time through the end of the sheave pocket nearest the bottom of the "B" section (5).

You're now ready to reassemble the "A" section into the "B" section as shown here:

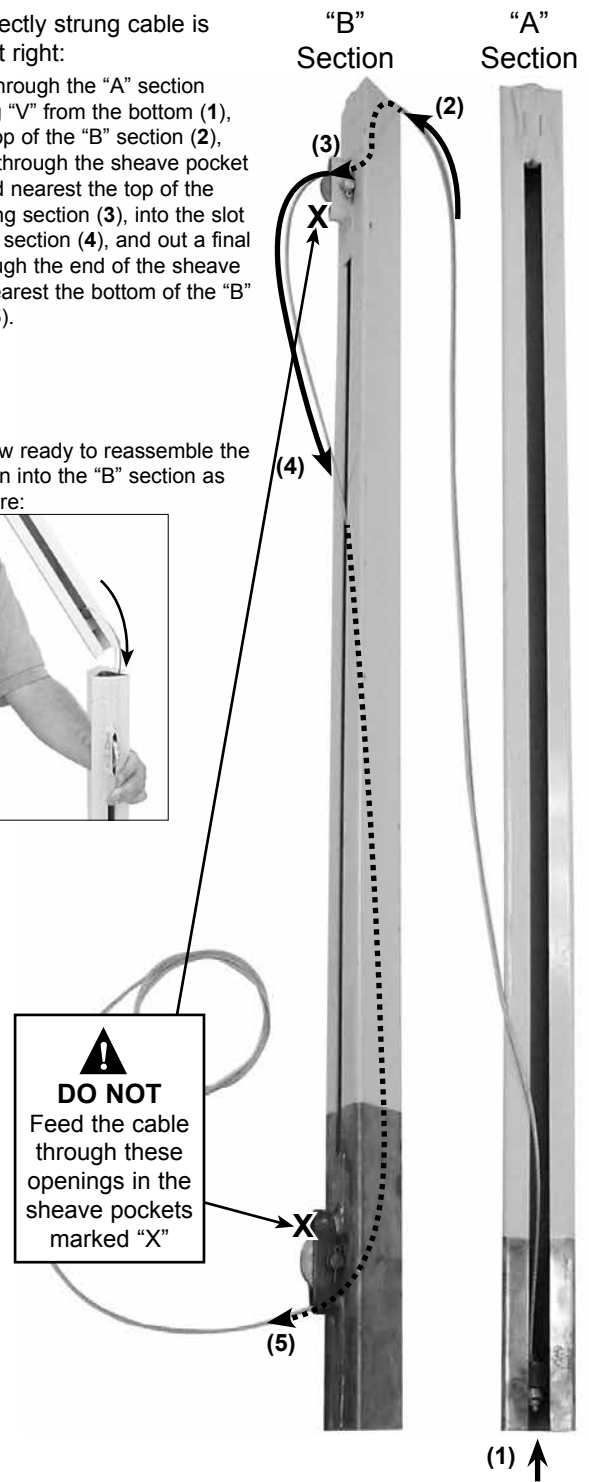

⚠ WARNING ⚠

- DO NOT feed the cable through the areas marked "X" in the photo above. Doing so will cause wearing of the cable for which it was not designed which can result in failure of the cable. Failure of the cable while the lift is raised will result in a sudden and rapid lowering of the lift and load possibly resulting in serious property damage and/or serious bodily injury.
- Failure to install the cable correctly as shown in these instructions can cause wearing of the cable for which it is not designed which can result in failure of the cable. Failure of the cable while the lift is raised will result in a sudden and rapid lowering of the lift and the load possibly resulting in serious property damage and/or serious bodily injury.

CABLE REPLACEMENT INSTRUCTIONS continued

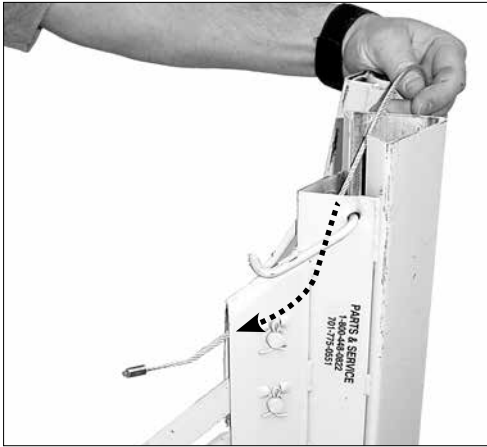

Front View

10. To reinstall the assembled telescoping sections, feed the crimped end of the cable through the frame sheave pocket from the top and over the top of the sheave as shown.

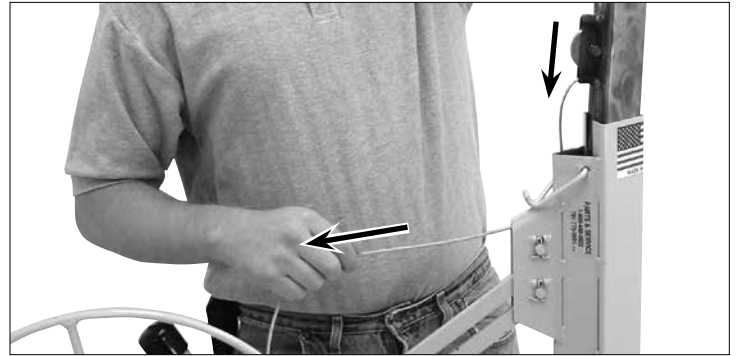

11. Pull the slack cable through the sheave pocket and slide the telescoping sections into the frame housing. As the telescoping sections lower into the frame, the slack cable will be drawn back up over the sheave.



12. Feed the crimped end of the cable through the hole in the winch drum and secure it behind the mooring tab by hand pulling the cable snug as shown.

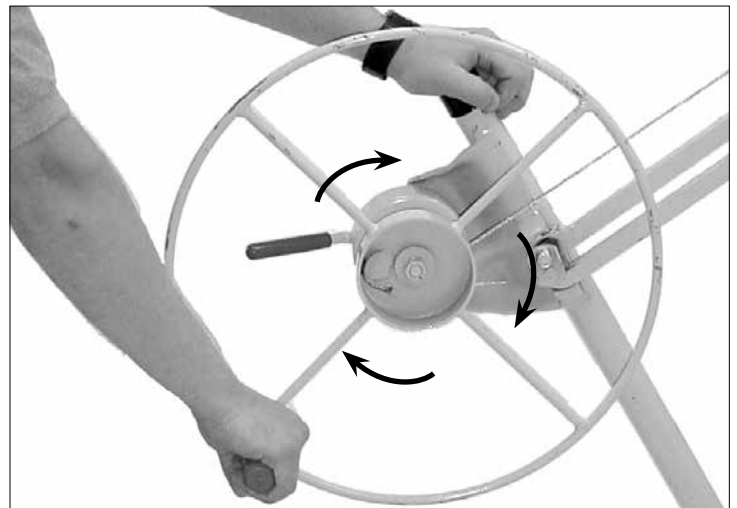

13. Rotate the winch in the direction shown to take the slack out of the cable.

Yes - Correct
Feed the cable over the top of the sheave like this.

NO!! - WRONG
DO NOT feed the cable under the sheave at this point!!



DO NOT feed the cable under the cable sheave on the frame as shown in this photo!

⚠ WARNING ⚠

The cable **MUST** feed down from the top of the frame housing and over the top of the sheave exactly as shown in step 7 in order to function properly. Failure to install the cable correctly as shown can cause wearing of the cable for which it is not designed which can result in failure of the cable. Failure of the cable while the lift is raised will result in a sudden and rapid lowering of the lift and the load possibly resulting in serious property damage and / or serious bodily injury.

INSTALLATION OF OPTIONAL EXTENSION 186

▲ WARNING ▲

The 186 extension is designed **ONLY** for use in the PANELLIFT® Model 138-2 or Model 125 frame:

- DO NOT install the 186 extension in the PANELLIFT® Model 182 frame or any other brand of drywall lift.
- Installing the 186 extension in any drywall lift frame other than the PANELLIFT® Model 138-2 or Model 125 can subject the assembly to stresses and loads that it was not designed to carry. This can result in failure of the unit possibly resulting in serious property damage and/or serious bodily injury.

BEFORE INSTALLATION OR USE, Determine whether you will be installing the 186 Extension into a PANELLIFT® Model 138-2 or Model 125, then completely read and understand the Operator's Manual for that PANELLIFT® Drywall Lift model. A free copy of the appropriate manual can be obtained by calling Telpro Inc. at 701-775-0551 or by going to www.telproinc.com and downloading a copy.

(NOTE: The following procedure is also to be followed when reinstalling the standard telescoping sections into the lift.)

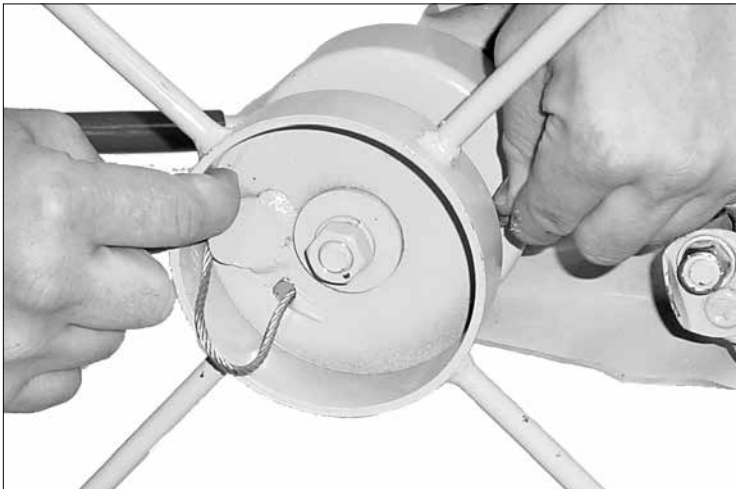

1. Loosen the cable from the mooring tab on the winch and pull it out from the winch drum. BE CAREFUL! A worn cable can have frayed strands. Wearing gloves will help protect your hands.

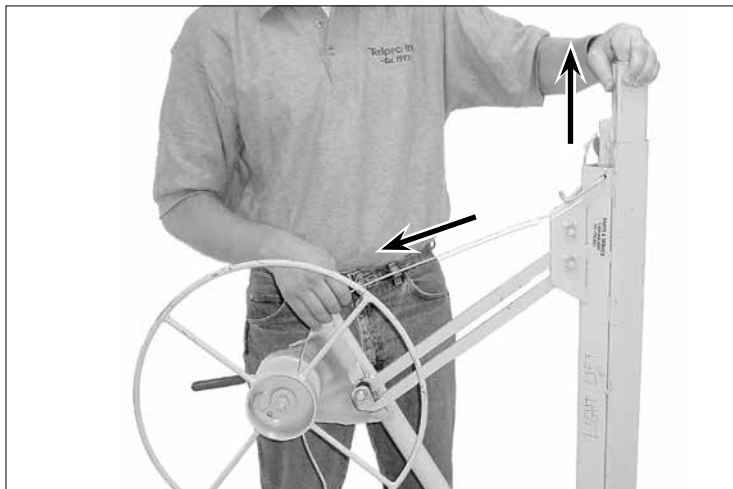

2. Pinch the two telescoping sections together and lift them out as a unit. Pulling the cable will help to raise them.

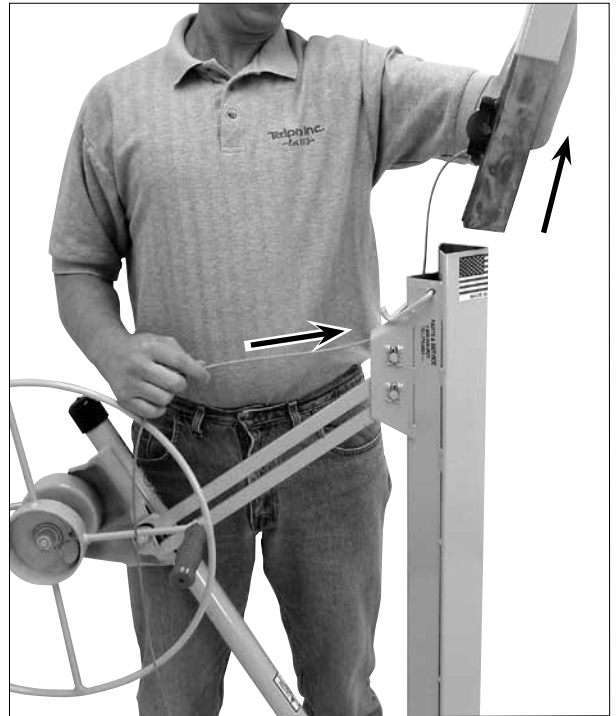

3. Remove the two telescoping sections completely from the frame housing. Pull the cable completely out from the frame along with them. BE CAREFUL for loose strands or frays on the cable.

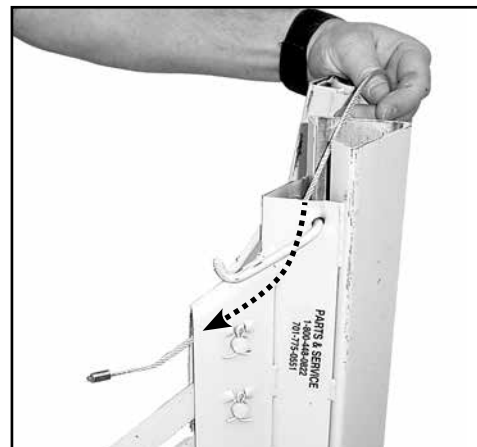

4. Feed the crimped end of the 186-00 cable through the frame sheave pocket from the top. It is **VERY IMPORTANT** that the cable passes **OVER THE TOP** of the cable sheave as shown here.



INSTALLATION OF EXTENSION 186

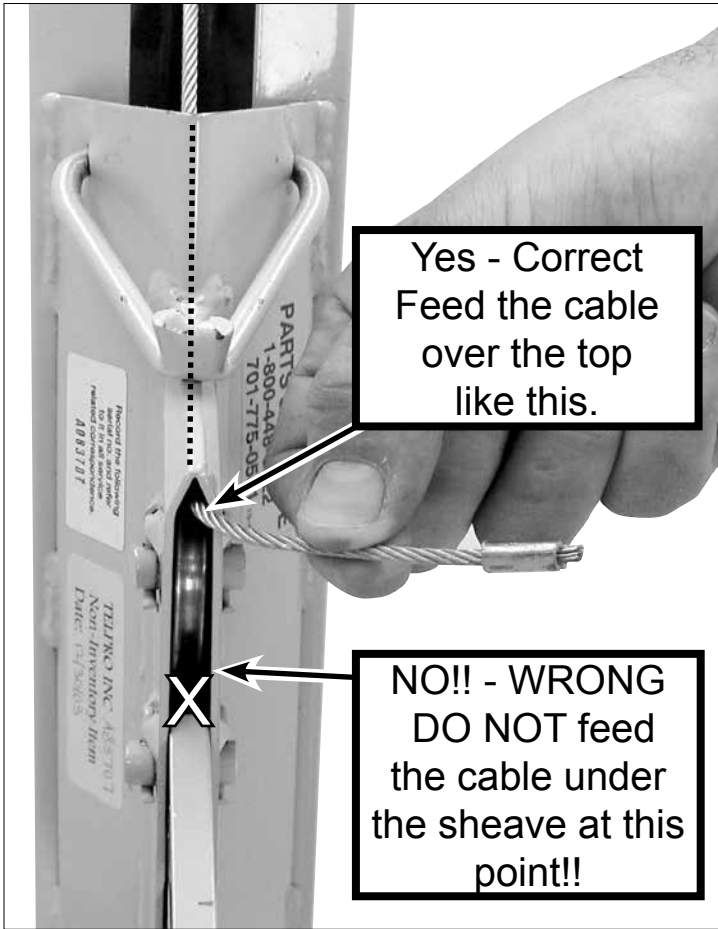

5. MAKE SURE that the cable feeds over the TOP of the cable sheave as shown in the above photo.

⚠ WARNING ⚠

The cable MUST feed down from the top of the frame housing and over the top of the sheave exactly as shown in steps 4 - 5 in order to function properly. Failure to install the cable correctly as shown can cause wearing of the cable for which it is not designed which can result in failure of the cable. Failure of the cable while the lift is raised will result in a sudden and rapid lowering of the lift and the load possibly resulting in serious property damage and / or serious personal bodily injury.



DO NOT feed the cable under the cable sheave on the frame as shown in this photo!



6. Pull the slack cable through the sheave pocket and slide the telescoping sections into the frame housing.

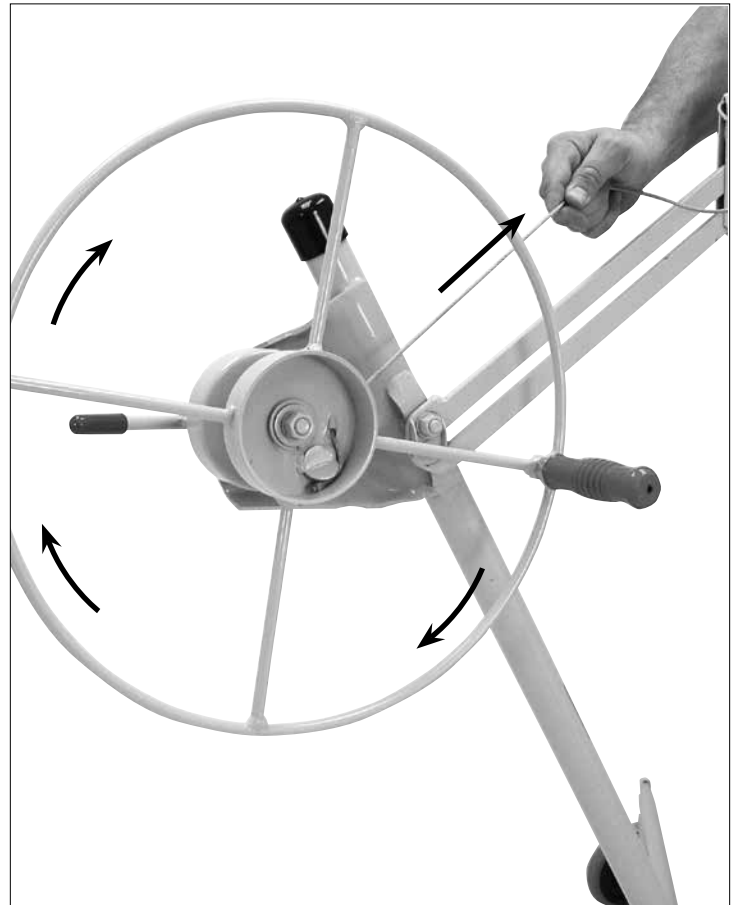

7. Feed the cable through the winch drum and secure it firmly behind the mooring tab as shown. Rotate the winch wheel in the direction indicated to take up the slack in the cable.

PARAGON PRO MANUFACTURING SOLUTIONS INC

LIMITED WARRANTY

TELPRO INC products manufactured by PARAGON PRO MANUFACTURING SOLUTIONS INC are warranted to be free from defects in material and workmanship under normal use for one year from date of purchase.

NOTE: The following components of the **PANELIFT® Model 439** Drywall Lift are warranted to be free from defects in material and workmanship under normal use for three years from date of purchase.

Part#	Description		
52-03	#35 chain assembly	52-05	#40 chain assembly
52-07	#50 chain assembly	52-09	1 1/4" #50 roller assembly
52-10	Outer plate set w/ bronze bearings	52-11	Drive assembly
52-12	1/2" x 2 1/4" Shoulder bolt w/ fasteners	52-15	Clutch assembly w/ sprocket
52-16	#40 winch drive chain		

If a TELPRO INC product is proven to be defective in material or workmanship within the covered time frame from the date of purchase, return the defective part to PARAGON PRO MANUFACTURING SOLUTIONS INC and we will either repair or replace the part at our option. We will neither assume nor authorize any other person to assume for us any other liability.

Written notice including commercial invoice detailing the nature of the defect, date of purchase, and the company from which you purchased your unit must be received and acknowledged by PARAGON PRO MANUFACTURING SOLUTIONS INC before any units may be returned. Shipping costs shall be the responsibility of the product purchaser.

This warranty shall not apply to any equipment that has been repaired or altered outside of the factory in any way so as in our judgment to affect its stability or reliability nor which has been subjected to abuse, misuse, or negligence.

PARAGON PRO MANUFACTURING SOLUTIONS INC reserves the right to make changes or improvements in design without incurring obligation to install the same on previous units.

PARAGON PRO MANUFACTURING SOLUTIONS INC shall not be liable for loss, damage, or expense directly or indirectly from use of its products, their transportation, their repair, or from any other cause. Acceptance of the manufacturer's product constitutes agreement to the terms of this warranty and further that the manufacturer shall have no liability for any special or consequential damages.

This Warranty is in lieu of all warranties express or implied.

Fill in the following information, attach a copy of your sales receipt or invoice and file in a safe place.

Date of purchase: _____/_____/_____

Name& model# _____

Serial #: _____

This product contains trace amounts of the following items which are known to cause cancer and/or developmental harm in the state of California.

These chemicals are not hazardous under product's intended use.

Please review CAS# for more information.

Chemical	Hazard	CAS#	% By Weight
Arsenic	Cancer	7440-38-2	Trace
Cadmium	Developmental	7440-43-9	Trace
Chromium	Cancer, Developmental	7440-47-3	Trace
Ethylbenzene	Cancer	100-41-4	Trace
Lead	Cancer	7439-92-1	Trace
Methanol	Developmental	67-56-1	Trace
Methylene Chloride (Dichloromethane)	Cancer	75-09-2	Trace
Nickel	Cancer	7440-02-0	Trace
Propylene glycol monobutyl ether	Cancer	5131-66-8	Trace
Toluene	Developmental	108-88-3	Trace

Questions about assembly?

Can't find a part?

Need some other help?

Contact us:

PARAGON PRO
Manufacturing Solutions

Telpro Inc.[®]

Product Support

800.448.0822

701.775.0551

sales@paragonpromfg.com

We'll get you set up!

Telpro Inc.[®]

Products are made in USA by

PARAGON PRO
Manufacturing Solutions

1-800-448-0822 • 701-775-0551

www.paragonpromfg.com • sales@paragonpromfg.com