

THE DRYWALL LIFTER
PANELLIFT®

Covered by one or more of the following patents: 3,828,942 5,368,429 5,586,619 5,984,605 7,556,464 7,726,901 Other patents pending.

OPERATOR'S MANUAL

For Model 439



⚠ WARNING ⚠

Read and become familiar with this manual BEFORE operating unit.

Before operating this equipment, thoroughly read this set of instructions, make sure you understand them, and only then follow the step-by-step directions. Failure to do so could result in serious property damage and / or serious bodily injury.

PARAGON PRO
MANUFACTURING SOLUTIONS

To our valued customer,

Thank you for choosing a **Telpro Inc.**® product by **PARAGON PRO** Manufacturing Solutions. We are pleased that we are able to provide equipment to make your work easier.

Our efforts are focused on producing the finest quality equipment of which we are capable. We make sure to spend extra time and effort on our design and production in order to reduce your time and effort spent using the product.

We take pride in providing the best for our customers. Quality, innovation, and excellence are all qualities this company ensures. No product is sent without being factory tested and inspected to ensure the highest quality for you.

It all began in 1972 when Roland Young designed our first product, the PANELLIFT® Brand Drywall Lift, and revolutionized the drywall industry. To this day we are continuously making advancements in manufacturing and design.

Thank you again for giving us the opportunity to work with you. Any questions or comments that you have are always welcome.

PARAGON PRO
M a n u f a c t u r i n g S o l u t i o n s

CONTENTS

Warning / Instructional Information	Pages 1
User Components & Product Specifications	Page 2
Care & Maintenance	Page 3
Assembly	Pages 4-5
Operation	Page 6
Disassembly.....	Pages 7
Chain Adjustment.....	Page 8
Parts Index.....	Pages 9-10
Order Form.....	Page 11
Optional Accessories	Page 12

ALL PHOTOS ARE FOR ILLUSTRATIVE PURPOSES ONLY.

ALWAYS WEAR PROPER PERSONAL PROTECTIVE EQUIPMENT.

⚠ Warning ⚠

Read and follow these warnings and the instructions that follow. Failure to do so could result in serious property damage and/or serious bodily injury.

• **BEFORE** operating this equipment, thoroughly read this set of instructions, make sure you understand them, and only then follow the step-by-step directions. **FAILURE TO READ AND FOLLOW THESE INSTRUCTIONS** could result in failure of the equipment. Failure of the equipment while the lift is raised can include a sudden and rapid lowering of the lift and load possibly resulting in serious property damage and/or serious bodily injury.

• **DO NOT ROLL** a loaded PANELLIFT® Drywall Lift while the load is raised. Always keep the load lowered until the lift is in place beneath the space in which the load will be installed. Rolling a PANELLIFT® Drywall Lift while the load is raised can result in tipping the lift and load possibly resulting in serious property damage and/or serious bodily injury.

• Operate the PANELLIFT® Drywall Lift only on hard, flat, level surfaces free of obstructions, debris, clutter, pits, holes or openings. Failure to follow this warning can result in tipping the lift and/or load possibly resulting in serious property damage and/or serious bodily injury.

• The PANELLIFT® Drywall Lift is designed exclusively as a material lift and shall be used for no other purpose. The PANELLIFT® Drywall Lift is not a personnel lift or platform and shall not be used as such. Using the PANELLIFT® Drywall Lift for purposes other than a material lift can subject the unit to stresses and loads that it was not designed to carry. This can result in failure of the unit which may include a sudden and rapid lowering of the lift and the load possibly resulting in serious property damage and/or serious bodily injury.

• The PANELLIFT® Drywall Lift is made of steel which conducts electricity. Keep the unit away from live electrical wires. Failure to do so could result in electrocution.

• Use only factory authorized replacement parts. Installation of other parts can compromise the safe design of the PANELLIFT® Drywall Lift and may cause failure of the unit possibly resulting in serious property damage and/or serious bodily injury.

• Moving the PANELLIFT® Drywall Lift from a cold environment to a warm one may cause condensation to form on metal surfaces creating a potential for malfunction. Such malfunction could possibly result in serious property damage and/or serious bodily injury: Allow the unit to reach working room temperature and check to make sure that the winch brake drum is clean and dry before operating.

• **CAUTION:** When the winch brake is released the winch will rotate backward and cradle will rapidly descend. If the winch is allowed to free-wheel backward, the winch handle can develop a great deal of rotational speed and potential for injury. To avoid possible serious personal injury or property damage always control the winch wheel firmly with the right hand before releasing the brake. **SEE INSTRUCTIONS ON PAGE 6**

• **DO NOT** pass your hand through the spokes on the winch when operating the unit as this could result in serious bodily injury.

• **Keep** hands, hair, and clothing away from chains and movable telescoping sections.

• Use and maintenance of the PANELLIFT® Drywall Lift shall be limited to authorized personnel who are trained in the proper techniques for its safe operation and maintenance and who are familiar with the various hazards of overhead material handling.

• As with any lifting equipment, **ALWAYS WEAR A HARD HAT** when operating the PANELLIFT® Drywall Lift and keep children away from the work area. Failure to do so could result in serious bodily injury.

• **DO NOT ATTEMPT TO USE YOUR PANELLIFT® Drywall Lift IF ANY PART IS MISSING, DAMAGED OR WORN. ORDER A REPLACEMENT PART IMMEDIATELY.** Using a PANELLIFT® Drywall Lift with missing, damaged or worn components can result in failure of the unit and possibly severe property damage and/or serious bodily injury.

• **INSPECT THE CHAIN ASSEMBLIES BEFORE EACH USE. REPLACE AT THE FIRST SIGN OF DAMAGE OR WEAR.** A worn, damaged or improperly installed chain can fail resulting in a sudden and rapid lowering of the lift and the load and possibly resulting in serious property damage and/or serious bodily injury. Inspect the chains by extending the lift fully and examining the full length of each lift chain for signs of damage or wear.

• **The weight capacity of the PANELLIFT® Drywall Lift is 150 lbs. (68 kg). DO NOT load the unit beyond this limit. When loading wallboard (or similar building panels), load only one sheet of wallboard at a time.** Failure to follow this warning can result in an unstable load and/or damage to the PANELLIFT® Drywall Lift contributing to a sudden failure of the machine and serious property damage and/or serious bodily injury.

• **DO NOT TAMPER WITH OR ADJUST** the torque setting on the load limiting clutch of the PANELLIFT® Drywall Lift. This is factory preset for the load range of the intended use of the lift. Altering this factory setting can subject the drive, lift, and brake mechanisms of the lift to stresses and loads that they were not designed to carry. This can result in failure of the unit which may include a sudden and rapid lowering of the lift and the load possibly resulting in serious property damage and/or serious bodily injury.

Questions? - Call Paragon Pro Manufacturing Solutions Customer Service at 1-800-448-0822 or 701-775-0551

USER COMPONENTS & SPECIFICATIONS

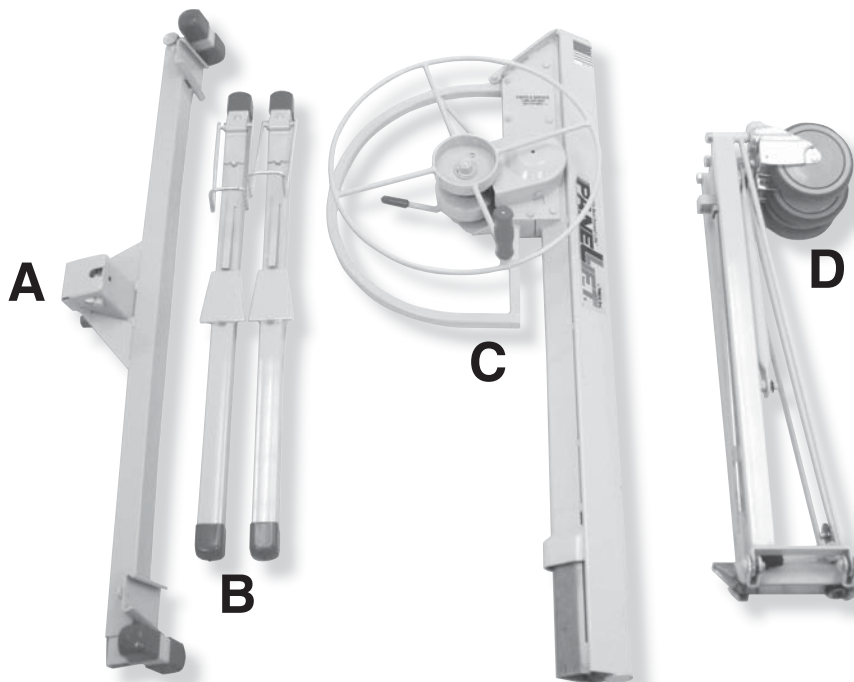

- A. Cradle Assembly - less detachable cross arms
- B. Cradle Cross arms (1 pair)
- C. Frame Assembly with winch and telescoping sections
- D. Tripod Base Assembly

SHEET QUANTITY CAPACITY
LOAD RATING
MAXIMUM HEIGHT
LOADING HEIGHT
NET WEIGHT

Single
150 lbs. (68 kg) DO NOT EXCEED.
14' 5" (439 cm)
15' 11" (485 cm) w/ optional 18" extension
37" (94 cm)
Approximately 124 lbs. (56 kg)

SEE PAGE 1 FOR IMPORTANT OPERATIONAL WARNINGS

CARE AND MAINTENANCE

- **Inspect chains FREQUENTLY. (At least daily and before each use). Replace at the first sign of damage or wear or if they do not flex freely. Check that clips on master links are fully connected and not loose. (See Warnings on page 1)**
- **Keep the chains, chain rollers, and caster bearings lightly lubricated and do not expose them to moisture. Be careful not to over oil, as excess drip oil may cause grit to accumulate between moving parts.**
- **Avoid dropping drywall screws and other debris into the telescoping sections and other openings in the PANELLIFT® Drywall Lift. They can cause jammed chains and possibly lead to damage to the lift.**
- **If needed, order replacement chains from Telpro Inc. (see Order Form, page 11). Use only factory authorized replacement parts. Installation of other parts can compromise the safe design of the PANELLIFT® Drywall Lift possibly resulting in serious property damage and/or serious bodily injury.**
- **Do not allow grease or oil to contact the surface of the winch brake drum. (Powdered gypsum applied to the brake will help dry the surface.)**
- **Do not allow grease or oil to contact the surface of the winch brake drum. (Powdered gypsum applied to the brake will help dry the surface.)**
- **Apply household paraffin to the surfaces of the telescoping sections, for smoother action.**
- **Store the PANELLIFT® Drywall Lift in a dry place.**
- **Take reasonable care to avoid damaging the PANELLIFT® Drywall Lift when transporting it.**
- **Do not hammer on any members or components of the PANELLIFT® Drywall Lift.**



ASSEMBLY

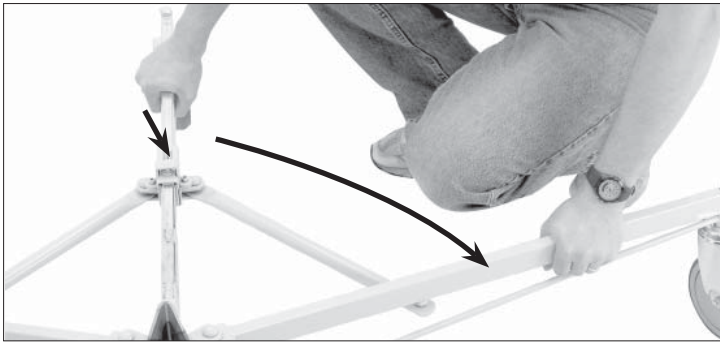

1. Begin by setting up the tripod base: press down on the slide yoke pin clip and swing the outer legs out until they lock in the working position (note the holes on the bottom of the slide tube).

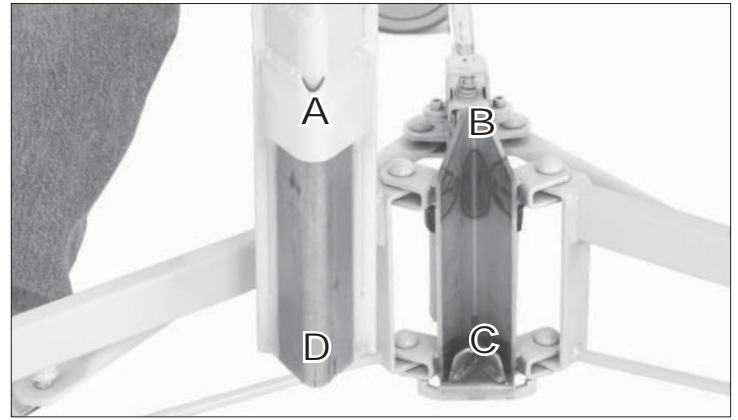

3B. Pocket "A" slides OVER angle "B" while angle "C" slides INSIDE angle "D".

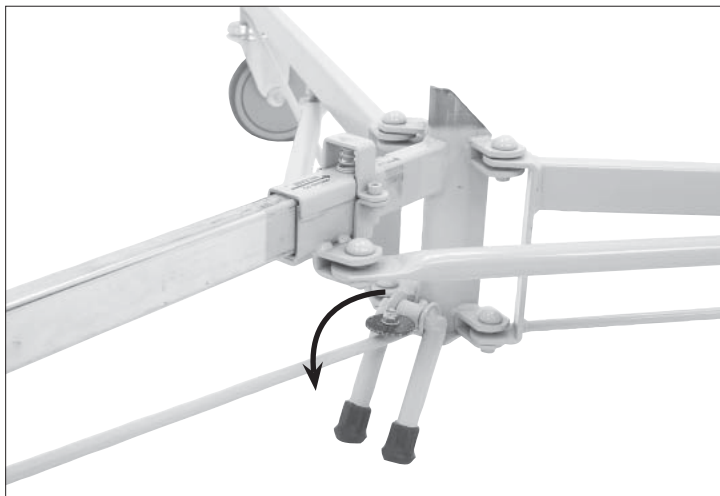

2. Set the backstop as shown to hold the tripod in place when attaching the frame.



3C. When the frame is correctly positioned on the tripod base release the backstop.



3A. Place the frame assembly on the tripod base.

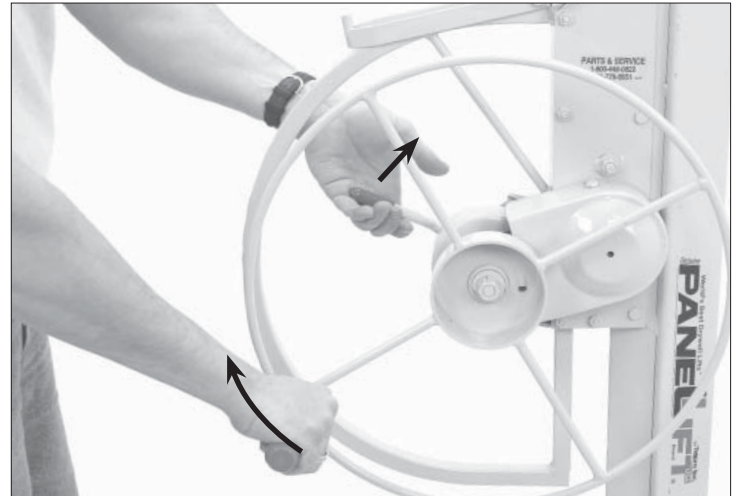

4A. Release the telescoping section retaining hook by rotating the winch wheel forward with your right hand while raising the brake arm with your left hand.

ASSEMBLY continued

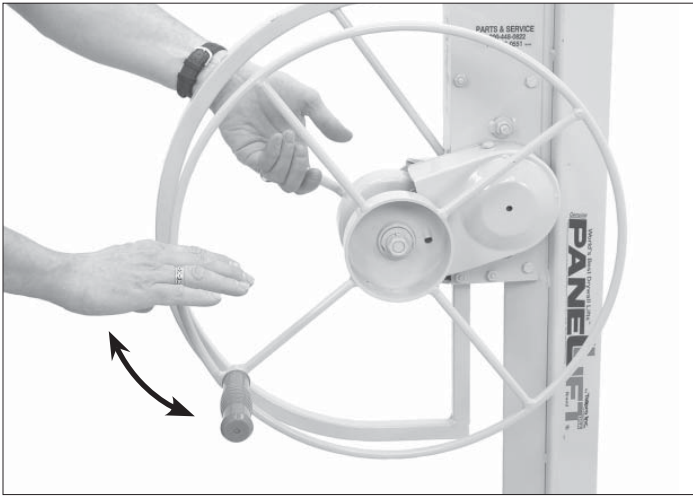

4B. Hold the brake arm in the raised position and allow the winch wheel to find a neutral position.

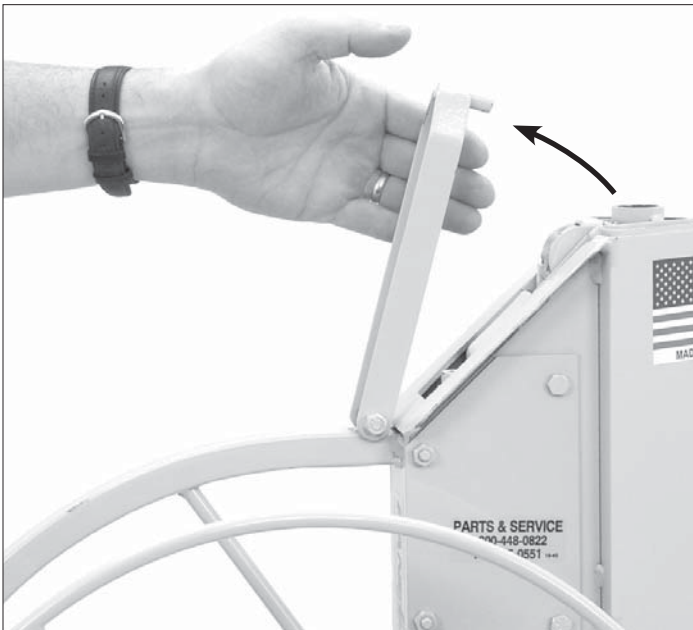

4C. Release the brake arm and swing the retaining hook to the open position.

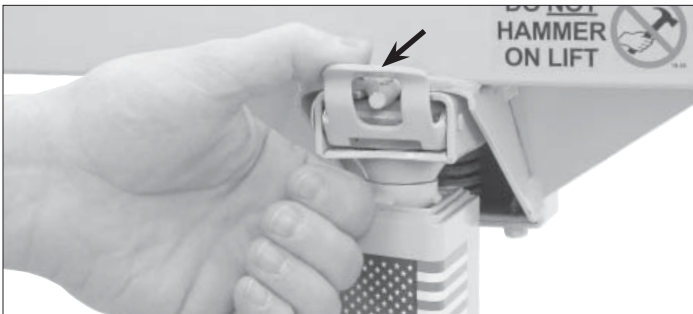

5. Mount the cradle on top of the telescoping section. Flip out the tilt latch to allow the cradle to tilt for loading and for hanging drywall on sidewalls and sloped ceilings.

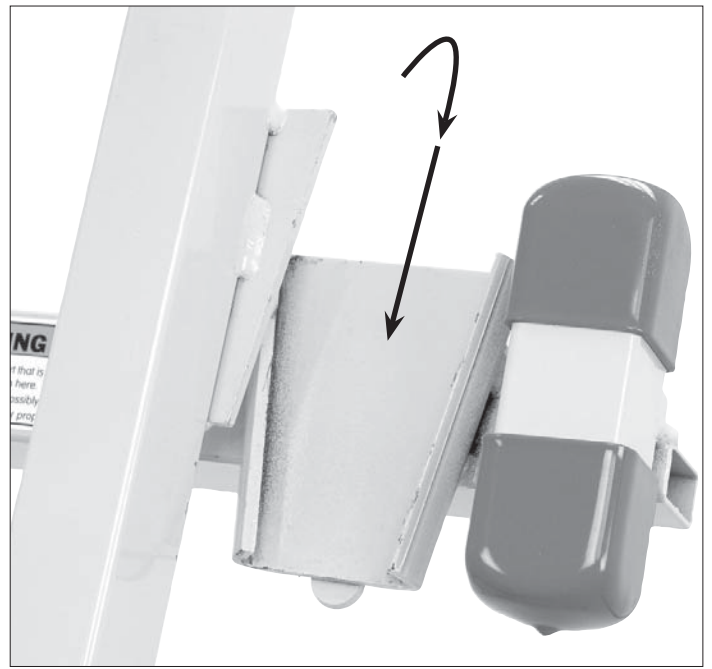

6. Place the tapered plates of the cross arms into the tapered sockets on the cradle. The spring tab on the back of the cross arm will lock it into place.

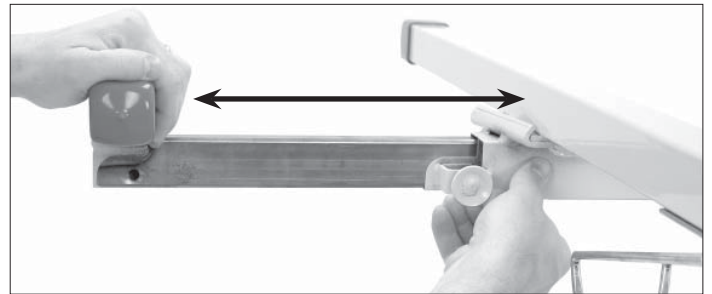

7. To extend the outriggers for use, pull out on the outrigger lock pin with your right hand and slide the outrigger out with your left hand as shown. The lock pin will engage at three different points on the outrigger: fully retracted, extended 21", or extended 33". **MAKE SURE** that the lock pins are engaged in one of these three positions before loading the unit. **DO NOT** use the PANELLIFT® with the outriggers extended beyond the 33" point. *Retract the outriggers when storing or transporting the unit.*

OPERATION



When the backstop legs are set, they keep the unit from shifting while loading wallboard or while installing the frame on the tripod base.

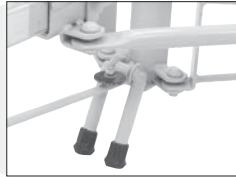

1. To Load: Set the backstop on the tripod base to hold the unit in position. Extend the cradle outriggers to properly support the drywall, tilt the cradle, and swing out the cross arm support hooks. Load the PANELLIFT® Drywall Lift from the front as shown with the face paper of the drywall contacting the cradle. (Note: the optional loader attachment shown on page 12 makes this process even easier.)

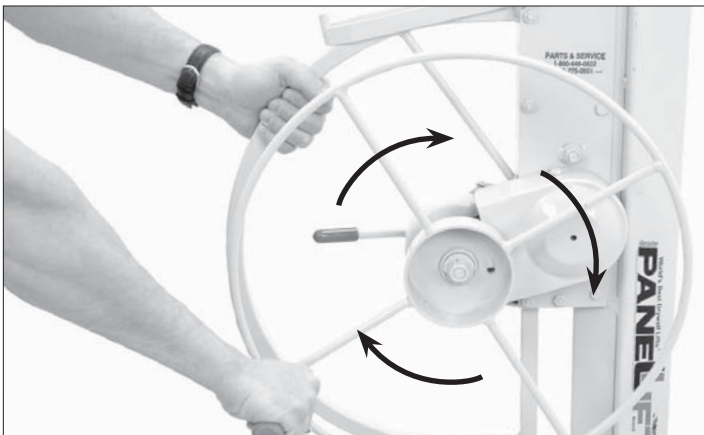

2. To raise the PANELLIFT® Drywall Lift rotate the winch wheel in the direction shown. The brake arm is spring loaded to hold the winch automatically at any height.

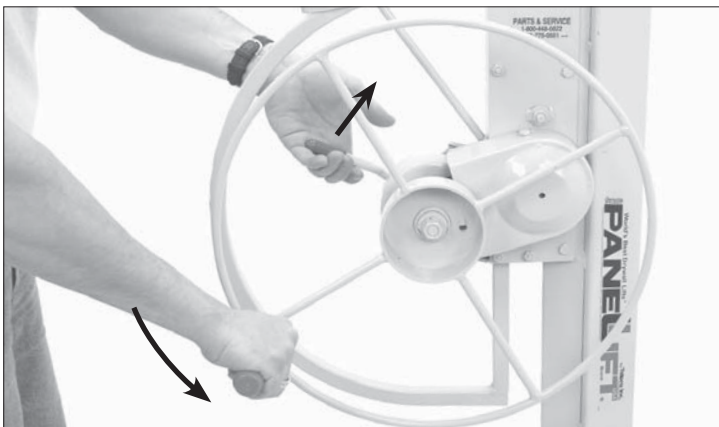

3. To lower the PANELLIFT® Drywall Lift control the backward rotation of the winch by grasping the winch handle with your right hand BEFORE releasing the brake with your left hand. ALWAYS use this two hand method when lowering the PANELLIFT® Drywall Lift.

4. The PANELLIFT® Drywall Lift will hold drywall in position on sidewalls and sloped ceilings in addition to level ceilings. The cradle also tilts up to 10° longitudinally.

USE THE BACKSTOP ON THE TRIPOD BASE WHEN WORKING ON SIDEWALLS AND SLOPED CEILINGS.

When working on sloped ceilings, start at the peak and work down.

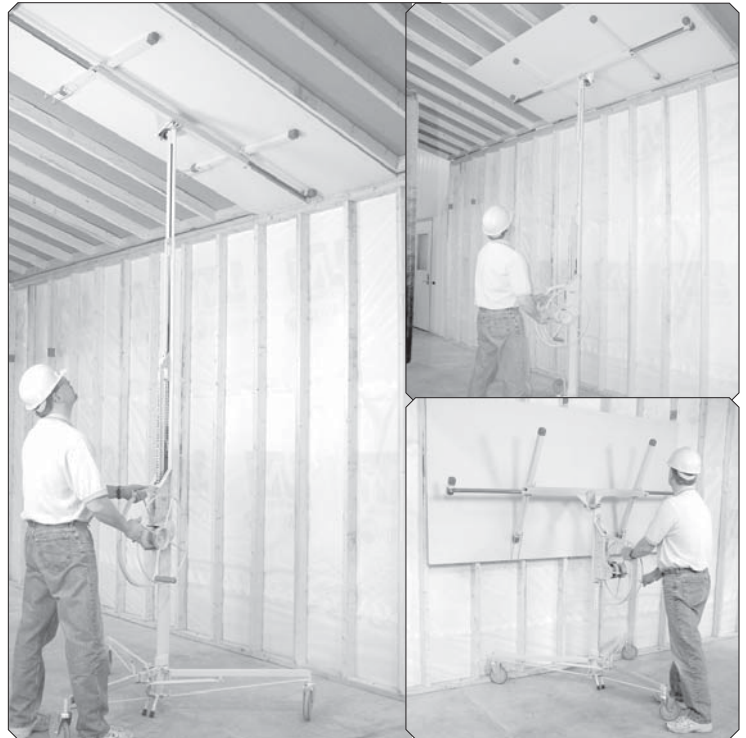

Photos are for illustrative purposes only.

⚠ WARNING ⚠

DO NOT ROLL
a loaded PANELLIFT® Drywall Lift while the load is raised. Always keep the load lowered until the lift is in place beneath the space in which the loaded wallboard will be installed.

Rolling a PANELLIFT® Drywall Lift while the load is raised can result in tipping the lift and load possibly resulting in serious property damage and/or serious bodily injury.

DISASSEMBLY

Disassemble the PANELLIFT® Drywall Lift as follows for transport and compact storage.

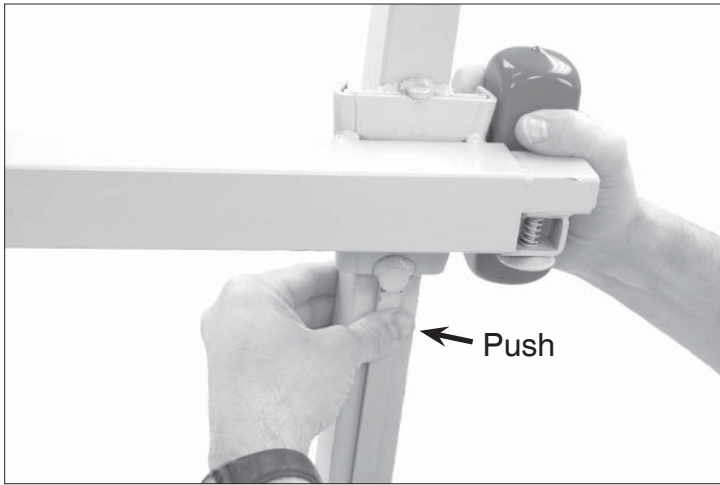

1. Slide the cradle outriggers all the way in.
2. Remove the cross arms by pressing the spring tab on the bottom and sliding the cross arm out of the tapered socket.

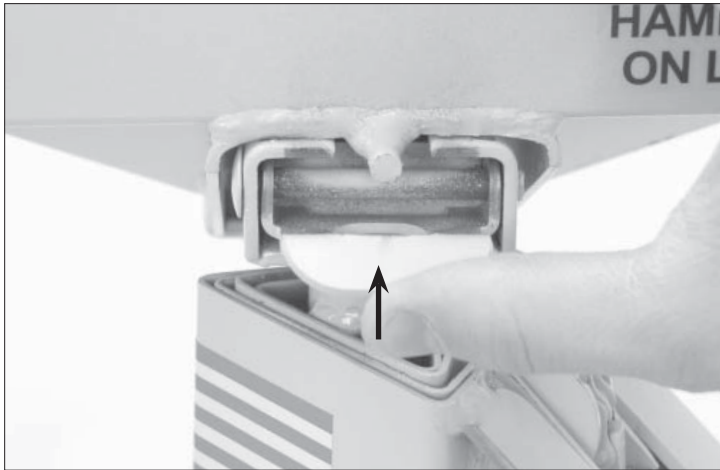

3. Lock the cradle tilt latch and lift the cradle off of the frame.

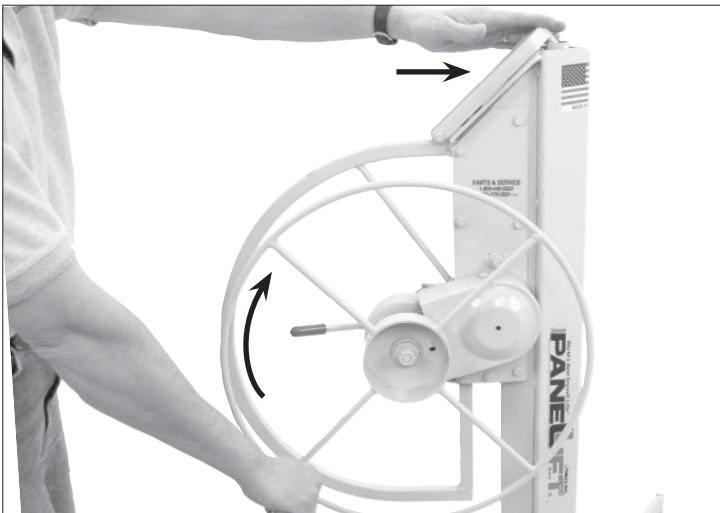

4. RAISE the retaining hook to engage telescoping sections. Rotate winch wheel slightly as shown.



5. Lift the frame off of the tripod base.

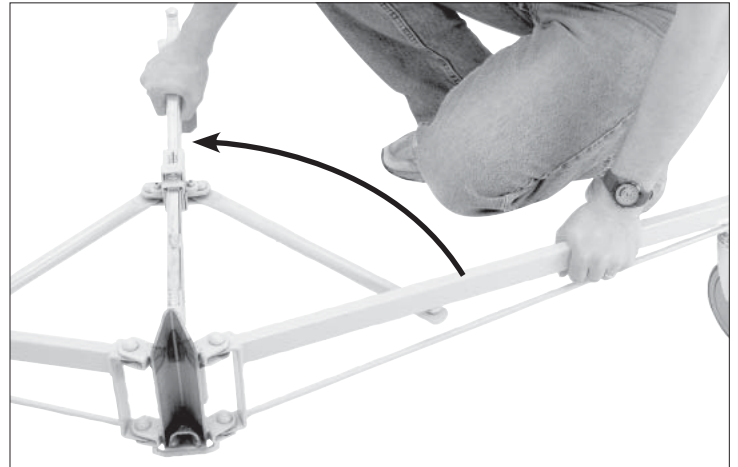

6. To collapse the tripod base, press down on the slide yoke pin clip and swing the legs in until they lock in the closed position.

CHAIN ADJUSTMENT

Adjusting the #50 Chain Coupler Nut Assembly

The #50 lift chain should have no slack when the lift is raised without the cradle and normally is slightly loose when the lift is under a load. If an adjustment is required proceed as follows. **Do not make this adjustment when the cradle is on the lift.** (If the lift is loaded when the adjustment is made, it will be too tight when loaded.)

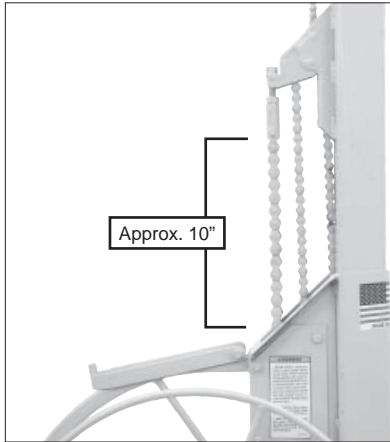

1. Remove the cradle and rotate the winch wheel to raise the telescoping sections until the coupler nut assembly is accessible and approximately 10" of #50 chain is visible.

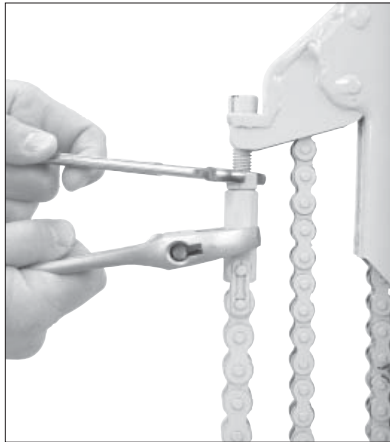

2. Loosen the jam nut from the coupler nut.



3A. Tighten the tension bolt using a 5/16" hex key just until the slack in the chain is removed.

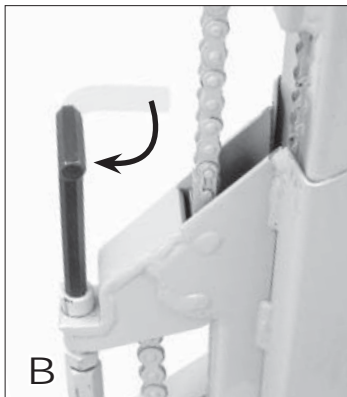

3B. Add 1/4" turn to achieve the correct tension.

-DO NOT OVER TIGHTEN: Too much tension on the #50 lift chain will exert a side-pull on the telescoping sections, causing them to stick and bind.

-Retighten the jam nut against the coupler nut to lock the adjustment.

Adjusting the #40 Winch Drive Chain

The #40 winch drive chain should be taut but not overly tightened as this will exert excess side load on bearings and drive components. To achieve correct tension proceed as follows. **Do not make this adjustment with the cradle on the lift.**



1. Start with the empty lift completely lowered. Remove the chain guard by removing the top and bottom bolts.



2. Loosen, but do not remove, the two winch mount bolts.



- 3A. Lift the brake handle with right hand to allow the drive chain to find a neutral, tensionless position.

- 3B. Pull the winch back to remove excess slack from the drive chain and hold while retightening the two mount bolts. Do not apply too much tension on the chain. Apply hand pressure only. Do not use a lever of any kind to increase chain tension.

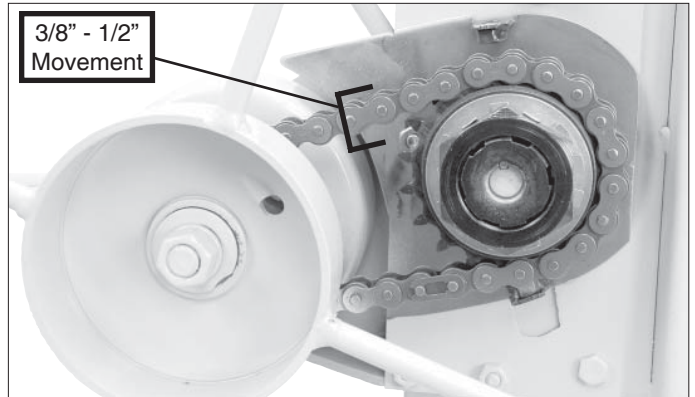

4. To check for proper tension, rotate the winch 1/2 turn to tension the lower portion of the chain. Move the upper portion of the chain up and down and measure the vertical movement of the upper portion of the chain midway between the sprockets. The correct distance of this movement should be approximately 3/8" to 1/2". If necessary repeat the previous steps until the correct tension is achieved. Replace the winch drive chain guard when the adjustment is complete.

PARTS INDEX Model 439

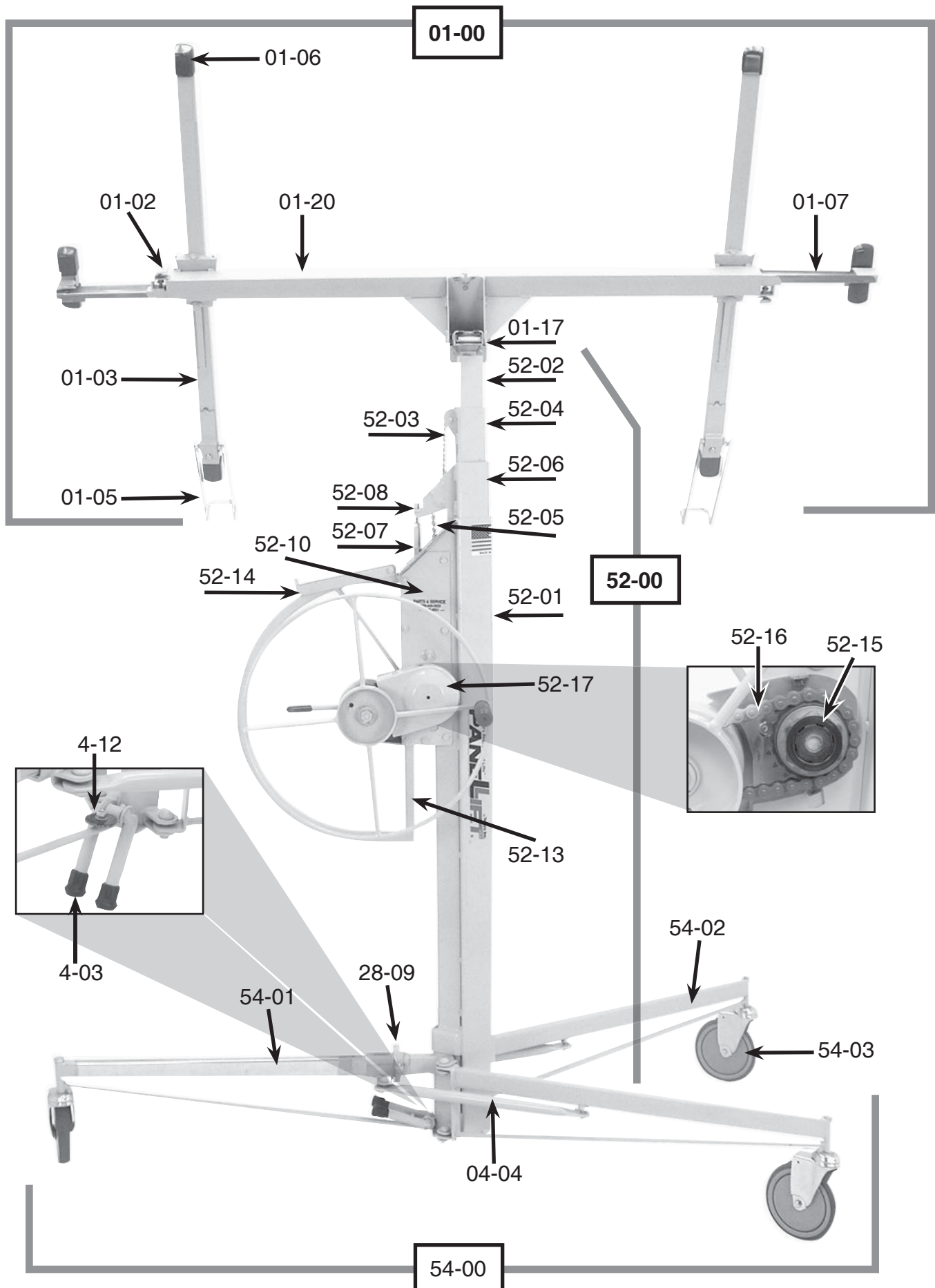

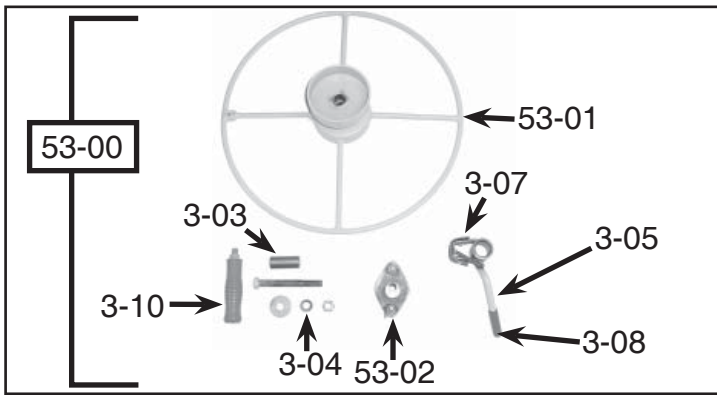

Winch Components

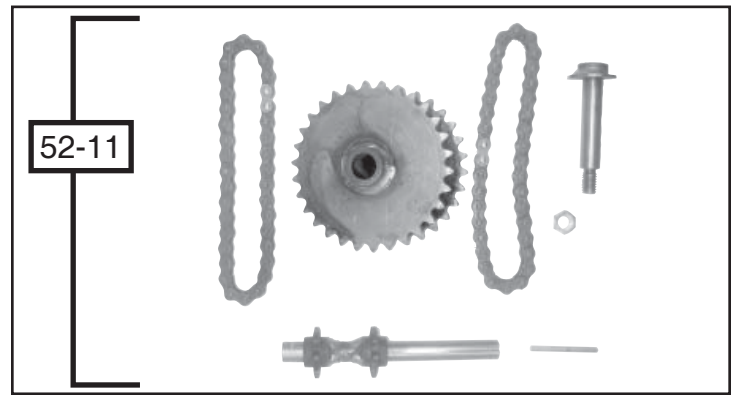

Drive Assembly

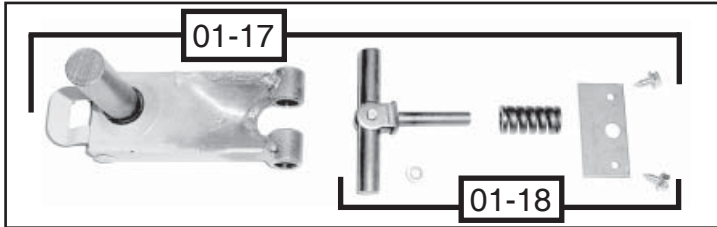

Mounting head components

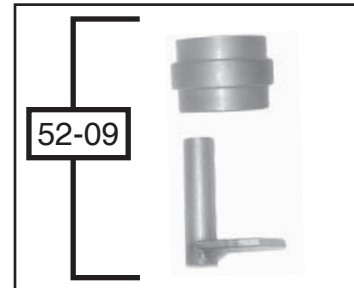

Roller Assembly

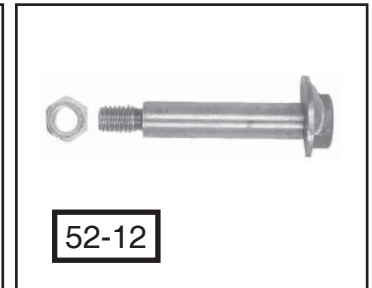

Bolt w/ fastener

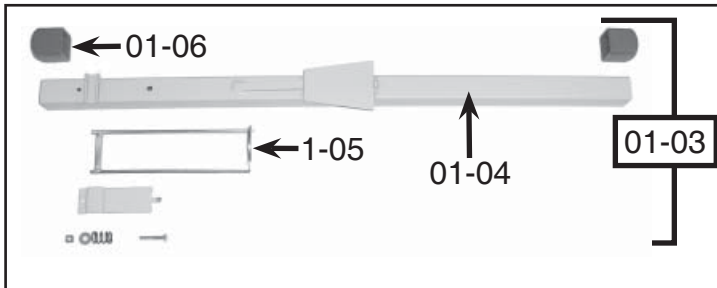

Cross arm components

FRAME UNIT continued

Part	Description
52-10	Outer plate set w/ bronze bearings
52-11	Drive assembly
52-12	1/2" X 2 1/4" Shoulder Bolt w/ Fasteners
52-13	Winch mount w/ fasteners
52-14	Retaining hook w/ fasteners
52-15	Clutch assembly w/ sprocket
52-16	#40 winch drive chain
52-17	Drive chain guard

CRADLE UNIT

Part	Description
01-00	Complete cradle assembly
01-02	Pull pin with fasteners
01-03	Complete cross arm assembly
01-04	Cross arm body
01-05	Support hook with fasteners
01-06	End caps (set of 8)
01-07	Outrigger with end caps
01-17	Complete mounting head assembly
01-18	Complete spring yoke pin assembly
01-20	Cradle Body

WINCH UNIT

Part	Description
53-00	Complete 439 winch assembly
53-01	Winch wheel with bronze flange bearings
53-02	Brake hub with bolts
03-03	7/8" bushing
03-04	1/2" bolt with washer and nut
03-05	Complete brake arm assembly
03-07	Tension spring "B"
03-08	Brake handle cover
03-10	Winch handle

FRAME UNIT

Part	Description
52-00	Complete frame assembly with winch & Telescoping Sections 439
52-01	Frame housing
52-02	"G" section w/ #35 chain assembly
52-03	#35 chain assembly
52-04	"H" section w/ #40 chain assembly
52-05	#40 chain assembly
52-06	"I" section w/ #50 chain assembly
52-07	#50 chain assembly
52-08	Coupler nut assembly
52-09	1 1/4" #50 roller assembly

TRIPOD BASE UNIT

Part	Description
54-00	Tripod base assembly w/ 6" Casters
54-01	Center Leg
54-02	Outer Leg w/ Fasteners
54-03	6" Caster w/ Fasteners
04-03	Backstop tip (Pack of 6)
04-04	Tie arm with fasteners
04-12	Backstop Fiber Washer w/ Fasteners
28-09	Slide Yoke Pin Clip w/ Fasteners



Loader Attachment Model 195

The PANELLIFT® Drywall Lift saves your back when lifting wallboard to walls and ceilings.

Make life even easier with this great accessory!

The Loader Attachment minimizes loading height to 4" instead of the standard 37". Drywalling has never been easier!

Original Back Saver!



Ultimate Back Saver!





Questions about assembly?

Can't find a part?

Need some other help?

Call us: PARAGON PRO
MANUFACTURING SOLUTIONS

1.800.448.0822

701.775.0551

We'll get you set up!