

Bio Smart Technologies

BioSmart® Infrared Heaters. *Feel the Difference.*



with Bio Smart® Air Filtration Technology.

BioSmart® Owner's Manual

*Therapeutic infrared heating systems
for a green, healthy environment*



Save these Instructions

Includes:
Application Guidelines
User Information & Guidelines
Operating Instructions
Warranty & Servicing

For Models BIO-1500PA & -WA Breathe Easy Platinum Edition Far Infrared Heaters



BioSmart® BIO-1500WA Breathe Easy Platinum Edition



BioSmart® BIO-1500PA Breathe Easy Platinum Edition

Table of Contents

Congratulations on Your Purchase!	3-4
Comfort Levels & Therapeutic Benefits	5
Energy Saving Benefits	6
BioSmart® Heater Features & Functions	9
Use Restrictions	10
Unpacking & Heater Care	11
Suggestions for Best Performance	12
Operating Instructions at a Glance	13
Maintenance Instructions	14
Detailed Operating Instructions	15-20
Turning Power On & Off	15
Operating the UV Air Filtration System	16
Setting the Temperature	17
Switching Between Fahrenheit & Celsius	17
Setting the Timer	18
Calibrating the Internal Thermometer	19-20
Frequently Asked Questions	21-22
Troubleshooting Your BioSmart® Heater	23-24
BioSmart® Heater Specifications - 1500WA	25
BioSmart® Heater Specifications - 1500PA	26
Diagram of BioSmart® Heater - 1500WA	27
Diagram of BioSmart® Heater - 1500PA	28
BioSmart® Heater Schematic	29
Warranty & Service Information	30

Congratulations on Your Purchase!

Congratulations on purchasing your BioSmart® Therapeutic Quartz Far Infrared Heater with BioSmart® Air Filtration Technology!

One of the best things about using your new BioSmart® Therapeutic Quartz Far Infrared Heater is the money you will save on your gas and electric bills.



You have just purchased the latest advancement in infrared heating technology, developed by BioSmart Technologies. Your new BioSmart® Far Infrared Heater contains our new advanced quartz far infrared heating element design and our proprietary patented air filtration technology, technology that is only found in BioSmart® Far Infrared Heaters — BioSmart® Air Filtration.

The technology represents a process for filtering and purifying air by utilizing specific processes in specific order to achieve unprecedented levels of purification without emitting ozone or harmful by-products back into the air. Specifically, the system consists of a double electrostatic filament filter, Negative Ion Generator, interactive TIO₂ surface coating for VOC break-down, UV emitter, double thickness gas absorption membrane consisting of activated carbon, and a proprietary blend of absorption materials for maximum effectiveness. The system process is the same one utilized in SterilAir5™ Air Purifiers manufactured by BioSmart Technologies. The system performance has been evaluated by two independent EPA certified air-quality labs and has received outstanding performance evaluations.

How many colds does your family get each year during the cold winter season? Do you know the reason why? In the winter, indoor air contains a lethal dose of mold, bacteria, virus and minute irritating

molecules called volatile organic compounds. BioSmart® Far Infrared Heaters rid your home of these contaminants while providing clean, energy efficient far infrared heat, which is both therapeutic and saves you money.

The average cost of a cold, per person, is about \$180 when you consider the doctor's call, the over-the-counter medications, and perhaps some lost school or work days. Centralized heat systems only exacerbate the problem, spreading germs and stale indoor air throughout every room of the house. The use of zoned, portable BioSmart® Far Infrared Heater technology solves all these problems, delivering heat only where it is needed and filtering out the contaminants that cause upper respiratory infections including colds, flu and asthma related symptoms.

If efficiency is your greatest concern, another great benefit about using your new BioSmart® Therapeutic Quartz Far Infrared Heater is the money you will save on gas and electric bills. Utility field tests show that BioSmart® Far Infrared Heaters use an average of 35% less energy than conventional electric furnace/baseboard systems. And with current fuel prices, the BioSmart® Far Infrared Heater will save you even more money than if you were using heating oil or gas heat. That means drastic reductions in your heating bills—up to 50%, depending on the type of heating system you have currently installed. BioSmart® heat penetrates everything in the room, from top to bottom. Heat in the room will never hover uselessly near the ceiling again.

The far infrared heating technology used in the heater also represents the latest patent pending technology developed by BioSmart Technologies. BioSmart® Far Infrared Heaters perform and function so outstandingly that when you experience the therapeutic benefits of a BioSmart® heater for 30 days you will agree that this is the best investment you have made all year.

Thank you for your purchase!

Why Use a BioSmart® Far Infrared Heater

What Is Far Infrared Heat & How does it work?

Far infrared heat, by virtue of its shorter wave length, is able to penetrate solid objects faster than radiant heat. The advantages of far infrared heat have been utilized for years as a therapeutic treatment for cardiovascular and general circulation problems.

Comfort Levels & Therapeutic Benefits of Using Far Infrared Heat with BioSmart® Air Filtration

The comfort levels achieved when using far infrared heat are superior to those of radiant heating systems. Far infrared heat *warms the body* faster so the energy that flows into the body is greater than when being absorbed from conventional radiant heating sources. Room temperatures of 68°F with far infrared feel like 72°F so you can set the thermostat back 4-5 degrees and experience the same comfort levels utilizing less energy to keep you warm and cozy.

BioSmart® far infrared heating systems are the ultimate in green technology engineering – exceptionally economical & extremely quiet, they produce comfortable, healthy, therapeutic far infrared heat. BioSmart® far infrared heating systems also sterilize the air that is processed through them making them a sanitary source of heat for those suffering from respiratory conditions. The BioSmart® Air Filtration system in a BioSmart® Far Infrared Heater represents 22 years of technology developments starting in 1987 when Bruce Searle began engineering commercial air filtrations systems for severe residential applications and the commercial hotel industry. The first patents for the system were filed in 1987 with multiple patents to follow representing the latest in air filtration technology.

Your BioSmart® Far Infrared Heater contains 5 air filtration mechanisms to insure the purest cleanest air available from a BioSmart® Far Infrared Heater. No other heater on the market can claim the advantages of the patented system contained in your BioSmart® Far Infrared Heater. The problems

everyone faces in the winter from colds and germs not to mention the proliferation and cross-contamination of air-borne contaminants in the school room and the office environment are eliminated when using a BioSmart® Far Infrared Heater.

Problems with HVAC systems: With the intent of economizing and saving on building costs, most contractors will combine the heat & air conditioning ducts into one distribution system. This makes the cross-contamination issue through the air conditioning ducts a potential health problem, especially for those with respiratory sensitivities and allergies, including asthma. When using a BioSmart® portable heating source, you eliminate the cross-contamination through the duct work to distribute the heat through the various rooms of a home or office. Eliminating the ductwork also eliminates the bacteria, dust, pollen, and mold that accumulates in a conventional air conditioning and heat duct system.

Energy Saving Benefits

Far infrared heat waves are transferred more quickly throughout the room due to their shorter wave length. The results are impressive because it requires less energy to heat the room evenly with far infrared heat than with radiant heating sources. This makes far infrared heat the most cost-efficient solution for a supplemental heating source or for heating your whole home.

If you really want to save on energy costs, the cost of heating with BioSmart® far infrared heat is going to be spectacular. *Usually a 50% savings over conventional heat sources is achieved*, even with other electrically generated heating systems. As much as 65% savings is achieved if replacing heating oil or other fossil fuel heating systems.

Why Use a BioSmart® Far Infrared Heater

Quiet Operation

BioSmart® Far Infrared Heaters with BioSmart® Air Filtration technology have two heat settings corresponding to two different speeds. The low speed setting (below 28 dB) is virtually silent and can be operated in the bedroom without distraction. BioSmart® Far Infrared Heaters are quieter than forced air systems and they do not have the typical cracking and popping sounds heard when heating with baseboard heaters. The BioSmart® Far Infrared Heater has a specially designed laminar flow fan rated at 38 dB on high, compared to the typical 48 to 56 dB for other comparable portable heaters.

Accurate Temperature Regulation

BioSmart® portable heaters utilize state of the art electronics and internal electronic thermostats for pin-point one degree accuracy. That means more accurate control of comfort level settings and a warm comfortable environment for you and your family.

Cost-Effective

Components in the BioSmart® portable heaters are designed to last 3 times longer than in conventional heating systems. BioSmart® warranty coverage and service procedures are simple to follow and they can be serviced usually in 5 minutes or less, should repair be required.

Stylish & Functional

BioSmart® infrared heaters are stylish and functional with a modern but stylish contemporary design making them an attractive addition to any room. There are several different colors to choose from to match the décor of your home or office.

Patented Proprietary Technology

BioSmart® Far Infrared Heaters contain a host of patented and patent pending innovations found only in BioSmart® Far Infrared Heaters. Among the patented features of the BioSmart® Far Infrared Heater are the BioSmart® Air Filtration system, the new heat exchanger, the new contact mechanism for the high efficiency infrared tubes and the design parameters and functions of the cabinet and the control panel itself.

More than 19 patents have been filed world-wide on innovations and improvements that have been incorporated into the BioSmart® Far Infrared Heater with BioSmart® Air Filtration. There are no imitations or substitutes in the market place with the technology or the features offered in the BioSmart® Far Infrared Heater. It's the technology that makes the BioSmart® Far Infrared Heater a truly unique energy efficient and super clean heat source for your home or office.

Quality Assurance

BioSmart® Far Infrared Heating systems come with C-TUV-US certifications representing equivalent approvals both in UL and CSA classifications. BioSmart® Far Infrared Heaters are manufactured in Taiwan and China thru True Green Electronics, which includes a consortium of engineers, vendors and manufacturers including AcePower Electronics, a certified ISO 9000 manufacturer and the exclusive manufacturer for True Green Electronics heaters and air purifiers.

BioSmart® Heater Features & Functions

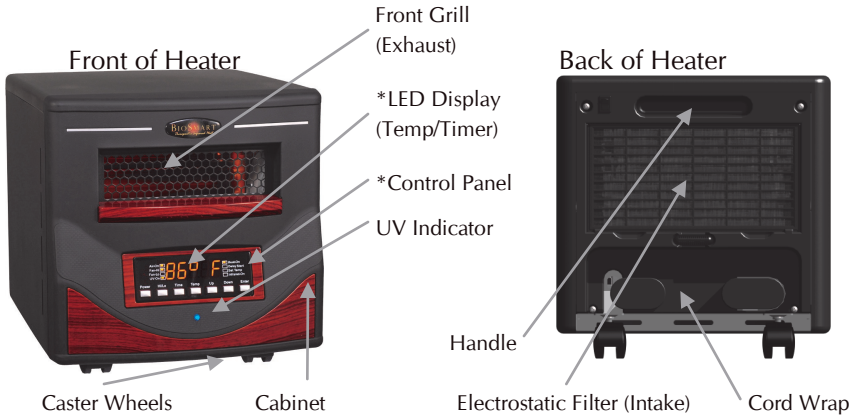

*Control Panel & LED Display

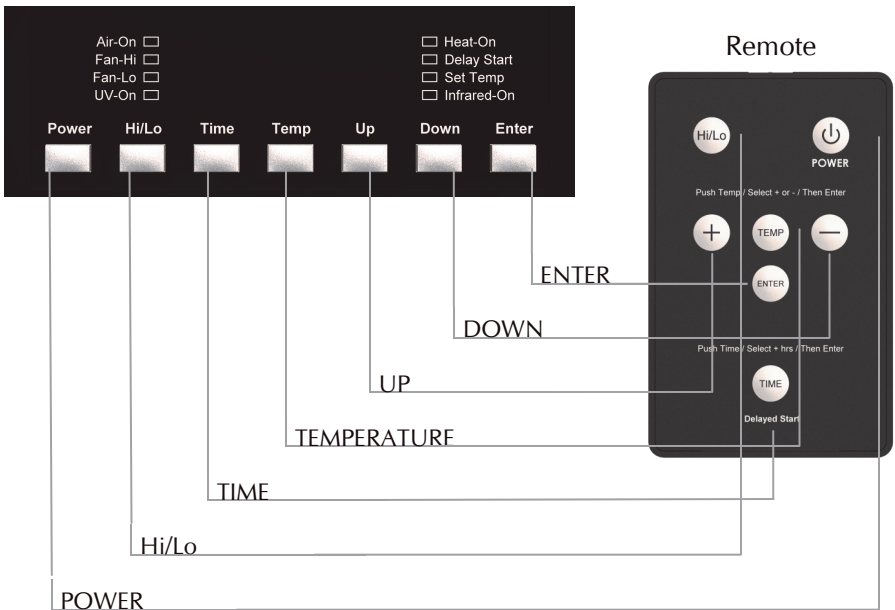

WARNING
 IMPROPER USE OF THIS HEATER COULD RESULT IN RISK
 OF FIRE, ELECTRIC SHOCK, OR INJURY TO PERSONS



WARNING
 ANY REQUIRED SERVICE OTHER THAN FILTER
 MAINTENANCE SHOULD ONLY BE PERFORMED BY AN
 AUTHORIZED SERVICE REPRESENTATIVE



CAUTION: RISK OF ELECTRICAL SHOCK
 DO NOT OPEN
 NO USER-SERVICEABLE PARTS INSIDE

USE RESTRICTIONS

READ ALL INSTRUCTIONS BEFORE USING THE HEATER

- DO NOT plug heater into any other cord connected device such as power strip, surge protector, multiple outlet adapter, grounding adapter, outlet-type air fresheners or extension cords. Plug into a 3-prong 120V 15 amp or higher grounded circuit receptacle only.
- DO NOT plug the heater into a loose fitting or broken receptacle.
- DO NOT alter the heater's design, or you will void the warranty.
- DO NOT block the front or rear of the heater.
- DO NOT place anything directly in front of the heater.
- DO NOT cover the unit as this may block airflow and cause the heater to malfunction.
- DO NOT use the heater outdoors or for heating construction sites.
- This heater is not intended for use in bathrooms, laundry areas and similar indoor locations. Never locate heater where it may fall into a bathtub or other water container.
- DO NOT force the filter to dry using any alternative methods when performing filter maintenance; doing so could damage the filter.
- DO NOT run cord under carpeting.
- DO NOT cover cord with throw rugs, runners, or similar coverings. Arrange cord away from traffic area and where it will not be tripped over.
- DO NOT insert or allow foreign objects to enter any ventilation or exhaust opening as this may cause an electric shock or fire, or damage the heater.
- Heater has hot and arcing or sparking parts inside. DO NOT use it in areas where gasoline, paint, or flammable liquids are used or stored.
- Heater is hot when in use. To avoid burns, do not let bare skin touch hot surfaces. If provided, use handled when moving this heater.
- DO NOT operate any heater with a damaged cord or plug or after the heater malfunctions, has been dropped or damaged in any manner. Return heater to authorized service facility for examination, electrical or mechanical adjustment, or repair.
- To disconnect heater, turn controls to off, then remove plug from outlet.
- Connect to properly grounded outlets only.
- To prevent a possible fire, do not block air intakes or exhaust in any manner. Do not use on soft surfaces, like a bed, where openings may become blocked.
- Use this heater only as described in this manual. Any other use not recommended by the manufacturer may cause fire, electrical shock, or injury to persons.
- Avoid the use of an extension cord because the extension cord may overheat and cause a risk of fire.
- This heater is for use on 120 volts. The adapter should not be used if a three-slot grounded receptacle is available.
- Heater must not be located immediately below a socket-outlet.
- DO NOT use this heater in or around a bath, a shower, or a swimming pool.

SAVE THESE INSTRUCTIONS

Unpacking Your New BioSmart® Heater

1. FIRST, inspect the package for any obvious damage.
2. Unpack the heater: cut open taped box edges, fold back box flaps. Gently turn entire box upside down; lift box from protective packaging.
3. Remove the protective packaging materials and turn upright; find a level and unobstructed location to place the unpackaged heater. (*NOTE: We recommend keeping the packaging for off-season storage and any transportation in the unlikely event that servicing is required.*)
4. Plug the power cord directly into an unused, grounded 120 volt, 15 amp or higher circuit receptacle.
5. Press the POWER button, located on the control panel. The heater's temperature setting will show **72° F** on the display. (*NOTE: To switch between Celsius and Fahrenheit, press the DOWN & ENTER buttons simultaneously and hold for about 3 seconds. The display will convert automatically.*)

Heater Care & Storage

General Maintenance and Cabinet Care

Clean the filter often to provide for maximum performance. When necessary, wipe the cabinet clean with a soft damp cloth and/or furniture polish.

Heater Storage

When the heater is not being used for an extended period of time, observe the following steps to preserve the life and performance of the unit:

- Unplug heater (Do not unplug heater while heater is running. Please see Operating Instructions - Turning Power Off.) - this will also help you conserve energy in your home or office.
- Gently wrap the power cord into the cord storage compartment in the back of your heater. This will help prevent undue wear and tear on the cord.
- Cover the heater to prevent dust from accumulating on or in heater.
- Store heater in a dry, low dust environment.

NOTE: Before resuming use of heater, ensure the filter and front grill are clean and clear of all dust and dirt. Also, observe the entire length of the power cord to ensure no damage has compromised the integrity of the cord.

Suggestions for Best Performance

To assure maximum performance of your BioSmart® Far Infrared Heater, please review the following recommendations:

- Do not locate the heater in an area with a high air exchange rate in and out of the room. Heat produced should be contained in the room.
- Try placing the heater near a warmer inside wall and direct the output toward a cooler outside wall. The cooler outside wall will tend to draw the generated heat towards it, which will allow for more efficient heating.
- Placing the heater next to a cold air return will draw the heat away from the area to be heated. Try closing or covering the cold air return. This will allow for more efficient heating.
- To ensure maximum efficiency, a 30% minimum relative humidity should be maintained in the heated environment. This is usually not a concern.
- The heater is designed to operate for maximum efficiency in the 68-74 degree range. Due to the soft heat concept, as explained earlier, temperatures at 68 degrees F feel as though it were 72 degrees F. This is due to the heat mixing with humidity evenly for head-to-toe comfort.
- When the heater is placed in an isolated area, i.e. basement or recreation area, any existing HVAC heating system vents should be closed in that area, if possible. This allows the heater to maintain the isolated area more efficiently.
- If placing the heater a few feet above the floor, such as in rooms with large areas of bare concrete, make sure the heater is secure and won't fall. This will allow for more efficient heating since concrete acts as a heat sink and will tend to draw the heat in its direction. Optimally, concrete floors should be covered to provide some insulation factor from the concrete.
- Set your central heating system to a lower temperature. Place the heater in the area you spend the most of your time. Now set the heater to your comfort level. There is no point in heating multiple rooms to 68+ degrees F when not in use.
- When heating larger areas, place the heater in a central location.
- If the heater is used in an extremely dirty or dusty area, the filter must be cleaned more frequently to maintain heater performance.

Operating Instructions at a Glance:

Turning Power On

Press the POWER button on the left side of the Control Panel. The heater's quartz heating elements will light up inside the heater. After a few minutes, once the air within the heater is warm, the heater fan will begin to operate.

Turning Power Off

Press the POWER button located on the left side of the Control Panel. The sound of the heater fan will continue until the heat has been completely vented, thus protecting the unit and preventing waste by cycling the remaining heat into the room. (NOTE: DO NOT unplug the heater until the sound of the fan has stopped. Doing so may cause damage to the unit.)

Setting the Temperature

This feature allows you to set the temperature your heater will maintain.

1. Press the temperature (TEMP) button on the Control Panel; the SET TEMP indicator will illuminate and the temperature display will flash.
2. Use the UP and DOWN buttons to select the temperature and press Enter.
3. The SET TEMP light will turn off, and the temperature is now set.

Setting the Timer

This feature allows you to set a future time for the heater to turn itself on. For example, if you set the time for 1 hour, the heater will turn on in 1 hour.

1. Turn the power off (heater must be powered off to use the timer feature).
2. Press the TIME button on the Control Panel—the two zeros to the right will flash (:00), indicating 0 minutes have been set, and the DELAY START indicator will illuminate.
3. Press the UP or DOWN button to select desired number of minutes (up to 59 minutes) that you would like the heater to wait to turn itself on.
4. Press the ENTER button—the two zero buttons to the left will flash (00:), indicating 0 hours have been set.
5. Press the UP or DOWN button to the desired number of hours (up to 24 hours), and then press the ENTER button.
6. DELAY START indicator will flash until the unit comes on after waiting the period of time you have set.

To cancel the timer, press the power button and the timer will stop.

Switching Between Fahrenheit & Celsius

Press the DOWN & ENTER buttons simultaneously and hold for about 3 seconds. The display will update automatically.

Maintenance Instructions

The only maintenance that is required for the heater is the periodic cleaning of the heater's electrostatic filter (located at the back of the unit). This cleaning should be performed at least once a month, or as dust becomes visible on the filter, to ensure efficient operation of the heater.

Cleaning the Electrostatic Filter

1. Power the heater off by pressing the POWER button, located on the left side of the Control Panel. (NOTE: The sound of the heater's fans will continue until the heat has been completely vented, thus protecting the unit and preventing waste by cycling the remaining heat into the room. *DO NOT unplug the heater until the sound of the fan has stopped. Doing so may cause damage to the unit.*)
2. When the heater's fans have stopped (the heater will become completely silent), unplug the heater .
3. Release the electrostatic filter by pushing the filter up from below .
4. Remove the electrostatic filter by pulling the filter down and out.
5. Clean the filter by vacuuming the filter until clear.
6. Replace the filter by sliding the top upwards into the spring-loaded slot on the back of the heater, then gently press the bottom of the filter into place.

Back of Heater

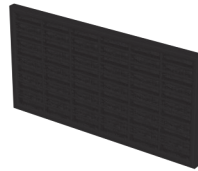

Electrostatic Filter

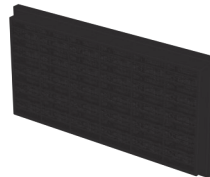

Electrostatic with BioSmart® Hydrocarbon Absorption Filter

Detailed Operating Instructions

Turning Power On

1. Press the POWER button on the left side of the Control Panel. The heater's quartz heating elements will light up inside the heater.
2. After a few minutes, once the air within the heater is warm, the heater fan will begin to operate.

Turning Power Off

1. Press the POWER button located on the left side of the Control Panel. DO NOT UNPLUG the heater, read further instructions:
2. The sound of the heater fan will continue until the heat has been completely vented, thus protecting the unit and preventing waste by cycling the remaining heat into the room. *(NOTE: DO NOT unplug the heater until the sound of the fan has stopped. Doing so may cause damage to the unit.)*



LED Display and Control Panel for Turning the Power On/Off

Detailed Operating Instructions

Operating the UV Air Filtration system.

This unit is designed to be run **with** or **without** UV processing and air purification. In order to activate the TIO₂ membrane, ionizer and UV emitter for maximum benefit of the air filtration system, it is necessary to turn the system on by pressing the ENTER button on the control panel or the remote control.

Pressing the ENTER button will sequence you through three options. You can choose to operate heater without the air purification by pressing the ENTER button and the appropriate LED lights on the front of the control panel will indicate that just the heater is operating.

You can choose to operate just the air purification year 'round without the heater on by pressing the ENTER button and the appropriate LED lights on the front of the control panel will indicate that just the air purifier is operating.

Lastly, you can push the ENTER button again and the LED lights on the front control panel will indicate that both systems are operating simultaneously. When both systems are turned on simultaneously, the UV and ionizer operate when the fan turns on to circulate the air through the heater. When just the air purifier is turned on, the fan operates full time on High or Low and the UV and ionizer remain on continuously.

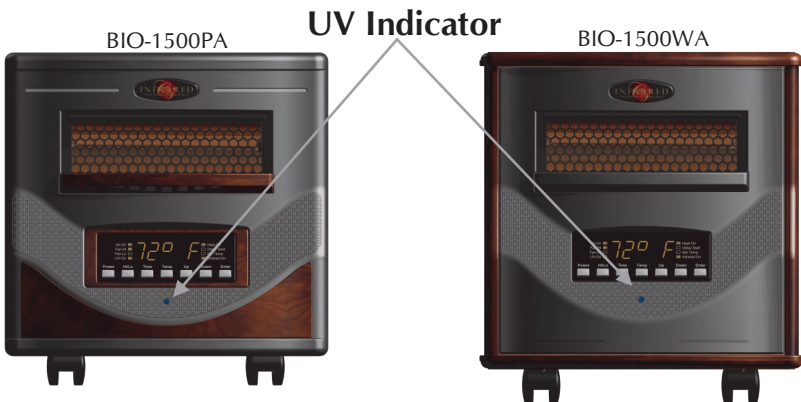

Detailed Operating Instructions

Setting the Temperature

This feature allows you to set the temperature your heater will maintain.

1. Press the temperature (TEMP) button on the Control Panel; the SET TEMP indicator will illuminate and the temperature display will flash.
2. Use the UP and DOWN buttons to select the temperature
3. Press Enter.
4. The SET TEMP light will turn off, and the temperature is now set.



LED Display and Control Panel for Setting the Temperature

Switching Between Fahrenheit & Celsius

Press the DOWN & ENTER buttons simultaneously and hold for about 3 seconds. The display will update automatically.

Calibrating the Internal Thermometer

The base-line calibration of the internal thermometer in the heater can be re-calibrated to match the room thermometer if it is not sufficiently accurate the way the heater arrived from the factory.



This procedure can be completed directly with the PCB controls on the front panel. Instructions for using the PC Board controls to change the base-line thermometer setting inside the heater are as follows:

1. Turn the heater on.
2. Determine base-line room temperature in the heater by pressing "up" and "down" at the same time. The room temperature detected by the heater thermostat will be displayed on the screen for 15 seconds. This may or may not correspond with the wall thermostat setting. This is what you are about to change.
3. Release the buttons and wait for 15 seconds for the unit to return to its regular functions.
4. To continue with the recalibration, press "up" and "enter" at the same time and hold until the room temperature appears on the display.
5. Press "enter" again. Ignore the existing number which is -9 to +9.

Calibrating the Internal Thermometer

This number is the arbitrary adjustment between the thermostat sensor and the temperature that was displayed on the screen when you pushed the "up" and "down" buttons at the same time in Step 1.

6. To adjust the temperature that was displayed on the screen in Step 1, press the "up" or "down" buttons to obtain a higher or lower base-line temperature for the internal thermostat on the heater.
7. Once the desired temperature is displayed on the screen, press the "enter" button again to exit the programming mode. The temperature setting displayed on the heater screen will now be measured against the new thermostat setting you have programmed into the heater.

This entire procedure can be followed skipping step 1 and using the temperature setting on any wall thermostat instead of the temperature setting on the internal thermometer in the heater.

Remember, the internal temperature measurement on the thermostat is only your starting reference point and it is strictly arbitrary. It is set at the factory and is usually within 2 degrees of reality.

By following this procedure you are setting the unit to precisely match the wall thermostat rather than the factory installed thermostat setting. Either set-point is fine depending upon the customer's preference.

Frequently Asked Questions

Q. Why is my heater still running after I have turned it off?

You will hear the heater fan running after you have turned the power off—this is to allow the heater to cool down, protecting the unit's components from overheating. Please take care to not unplug the heater while it is in operation and while it is running the cool-down cycle.

Q. Can I use the heater to heat multiple rooms at the same time?

The heating capability will depend on your floor plan, the insulation factor and the room size. Ceiling fans will help move heat around in rooms with many large windows but normally this is not necessary. Placing the heater in a central location will also help move heat between rooms.

Q. Will my heater work in damp or moist areas?

The internal components of BioSmart® Far Infrared Heaters are electro zinc plated and the screws are coated with black rust-inhibitor. Every manufacturing innovation has been incorporated in order to insure long life and dependability.

Using the heater in a damp or moist area such as a bathroom, pool room, or sauna room is effective but not recommended for the heater unless in constant use. Although the heater is designed to work effectively with natural humidity, we suggest you keep the heater away from areas that accumulate moisture.

Q. Will my heater work in areas without insulation?

The heater will work in garages, basements and unfinished rooms. However, please bear in mind that the effectiveness of your heater depends on how well the area is sealed and insulated. As with any heater, the better the walls, floor and ceiling are sealed and insulated, the more heat is absorbed into the objects in the room.

Q. Why is my heater's display showing only a line of dots?

The heater goes to a screen saver mode 10 minutes after you finish setting it. Your heater will activate the heat cycle automatically when the temperature of the room falls below the temperature you set. The heater will also pop out of screen saver mode when any button is pressed on the Control Panel. Screen Saver mode does not affect normal operation.

Frequently Asked Questions

Q. What will the BioSmart Air Filtration system remove from the air?

The BioSmart® Air Filtration system in the BioSmart® Far Infrared Heater will kill any biologically active contaminants that are present in the air including bacteria, virus, mold and mildew.

Additionally, the most lethal contaminants in indoor air include the volatile organic compounds that irritate the lung lining making an individual more susceptible to the bacteria and virus that are in the air. Without removing these, an air filtration system has only done half its job.

The BioSmart® Air Filtration system in the BioSmart® Far Infrared Heater contains an interactive TIO₂ panel that reacts with UV light inside the unit. The interaction of these two components breaks down volatile organic compounds. The ionization of these compounds assists the gas-absorption membrane in the filter cartridge to absorb these contaminants as they are broken down by the TIOS and the Ultraviolet light.

Once absorbed, these contaminants are held in the filter cartridge which should be replaced at the beginning of each winter season before first-use of the heater.

To re-order a new gas-absorption filter cartridge, refer to the back of the Owner's Manual for further directions.

Q. How long will the BioSmart® gas filtration cartridge last?

Usually about one winter heating season.

Q. Can I use multiple heaters in an area?

Depending on the size of the area, you may wish to use multiple heaters. Many heaters may be used. Your heater is rated at 12.5 amps so each heater must plug into an independent 15 amp, or greater, circuit.

Q. How does the BioSmart® Far Infrared Heater save me money?

The patented quartz heating elements in the BioSmart produce infrared heat waves which heat objects in the room quicker than conventional radiant heat waves. Using this type of heat can save up to 50% on your heating bill.

Troubleshooting Your BioSmart® Heater

Problem

Solution

The heater's airflow has been reduced.

Make sure the electrostatic filter is clean (see Maintenance).

Check front grill and look behind rear air intake for any objects that could obstruct airflow.

If the heater's airflow is still diminished or has stopped, please call Customer Support.

The heater stays on after I push the POWER button to turn it off.

This is a normal function of the heater. **DO NOT** unplug the heater until you no longer hear the fan running. During this time, the heater is cooling down.

The heater's display is showing a line of dots.

This is part of the heater's normal operation.

After a period of inactivity, the heater will enter into a "screen saver" mode to conserve power.

This will not affect the heater's operation.

When any function key is pressed, the heater's display will reappear.

Troubleshooting Your BioSmart® Heater

Problem

Solution

Heater thermostat temperature does not match wall thermostat temperature

See pages 19-20 of this manual for detailed instructions on calibrating your heater's thermostat.

The heater will not turn on.

Test the outlet to make sure there is power available and then check the heater display for the flashing TIME DELAY light.

Press the POWER button to turn off the timer and resume normal operation of the heater.

The heater's air flow is restricted or is too hot.

Check to see that the filter cartridge on the back of the unit is clean.

Use a vacuum cleaner to clean if necessary and re-install on the heater.

BioSmart® Heater Specifications

Model BIO-1500WA—Wood Cabinet with BioSmart® Air Filtration System

- **Wood Cabinet:** Marine grade plywood, 7 and 9 layer laminate with Tuscan Finish
- **Weight:** 28lbs
- **Dimensions:** 14" x 13 ½" x 16 ½" (H,W,D) [without optional gas absorption filter cartridge]
- **Power Requirements:** 120 Volt AC
- **Power Consumption:** High - 12.5 Amps, 1500 Watts; Low - 6.5 Amps, 750 Watts
- **Power Cord:** 6 ft – 14 gauge
- **Control Panel:** Electronic Digital – large numbers
- **Thermostat:** Three probe – Electronic Digital
- **Thermostat Accuracy:** $\pm 1^\circ$ (1 degree up and 1 degree down)
- **Delayed Start Function:** Up to 24 hours
- **Safety Cut-Off:** Yes
- **Listed Approvals:** CTUV-US (International UL Equivalent)
- **Remote Control:** Credit card type—large button surface
- **Cord Storage:** Yes
- **Pre-Filter:** Life-time electrostatic
- **Germicidal:** Ultraviolet Emitter 254nm
- **TIO2:** Yes – for VOC break-down, interacts with UV
- **Negative Ion:** Yes – Aids as a mood elevator and helps to increase concentration
- **Gas Absorption Cartridge:** (optional) for hydrocarbon (VOC) removal
- **Heating Elements:** 4 - 120 volt quartz infrared tubes
- **Quartz Life Expectancy:** 30,000 hours per bulb
- **Heat Chamber:** 3 Copper-Ion generation panels with additional negative ion generator for maximum efficiency
- **Fan System:** Dual Speed, high-output, sleeve bearing laminar-flow fan
- **Fan Noise Level:** 28 dB Low Speed / 42 dB High Speed
- **Warranty:** Limited 3-Year Warranty.



BIO-1500WTA—Walnut Wood

BioSmart® Heater Specifications

Model BIO-1500PA—Plastic Cabinet with BioSmart® Air Filtration System

- **Plastic Cabinet:** Black ABS 94-VO fire retardant nylon front cover and wood grain simulated trim
- **Weight:** 23lbs
- **Dimensions:** 14" x 13 ½" x 16 ½" (H,W,D) [without optional gas absorption filter cartridge]
- **Power Requirements:** 120 Volt AC
- **Power Consumption:** High - 12.5 Amps, 1500 Watts; Low - 6.5 Amps, 750 Watts
- **Power Cord:** 6 ft – 14 gauge
- **Control Panel:** Electronic Digital – large numbers
- **Thermostat:** Three probe – Electronic Digital
- **Thermostat Accuracy:** $\pm 1^\circ$ (1 degree up and 1 degree down)
- **Delayed Start Function:** Up to 24 hours
- **Safety Cut-Off:** Yes
- **Listed Approvals:** CTUV-US (International UL Equivalent)
- **Remote Control:** Credit card type—large button surface
- **Cord Storage:** Yes
- **Pre-Filter:** Life-time electrostatic
- **Germicidal:** Ultraviolet Emitter 254nm
- **TIO2:** Yes – for VOC break-down, interacts with UV
- **Negative Ion:** Yes – Aids as a mood elevator and helps to increase concentration
- **Gas Absorption Cartridge:** (optional) for hydrocarbon (VOC) removal
- **Heating Elements:** 4 - 120 volt quartz infrared tubes
- **Quartz Life Expectancy:** 30,000 hours per bulb
- **Heat Chamber:** 3 Copper-Ion generation panels with additional negative ion generator for maximum efficiency
- **Fan System:** Dual Speed, high-output, sleeve bearing laminar-flow fan
- **Fan Noise Level:** 28 dB Low Speed / 42 dB High Speed
- **Warranty:** Limited 3-Year Warranty.



BIO-1500PA – Plastic

Diagram of BioSmart® Heater—1500WA

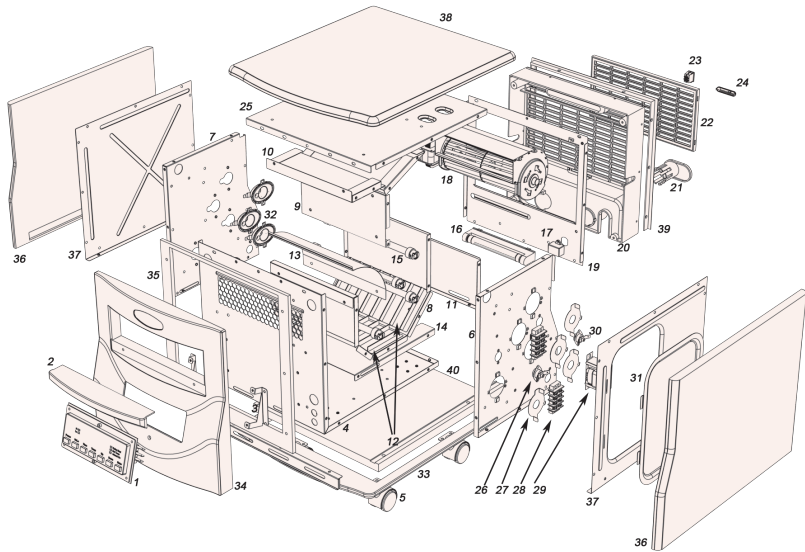

Parts List

- | | |
|-------------------------------|---------------------------|
| 1. Control Panel | 21. Power Cord Release |
| 2. Register Trim Piece | 22. Electrostatic Filter |
| 3. Control Panel Support (x2) | 23. UV and Ionizer switch |
| 4. Main Sheet Metal Body | 24. Temp Sensor Cover |
| 5. Caster Wheel (x4) | 25. Top Sheet Metal Panel |
| 6. Heat Exchanger Right Side | 26. Temp Sensor |
| 7. Heat Exchanger Left Side | 27. IR Bulb Cover (x4) |
| 8. Heat Exchanger Bottom | 28. Terminal Block (x2) |
| 9. Heat Exchanger Divider | 29. Transformer |
| 10. Heat Exchanger Top | 30. High Limit Switch |
| 11. heat Exchanger Back | 31. IR Bulb Access Cover |
| 12. Copper Plate (x2) | 32. IR Bulb Socket (x4) |
| 13. Copper Baffle | 33. Bottom Wood Trim |
| 14. Heat Blanket Support | 34. Front Cover |
| 15. Infrared Bulb (x4) | 35. Wood Divider |
| 16. UV Bulb | 36. Wood Side Panel |
| 17. Ionizer | 37. Metal Side Panel |
| 18. Cross Flow Fan | 38. Wood Top Panel |
| 19. Rear Sheet Metal Panel | 39. Plastic Seal |
| 20. Rear Plastic Cover | 40. Wood Bottom |

Diagram of BioSmart® Heater—1500PA

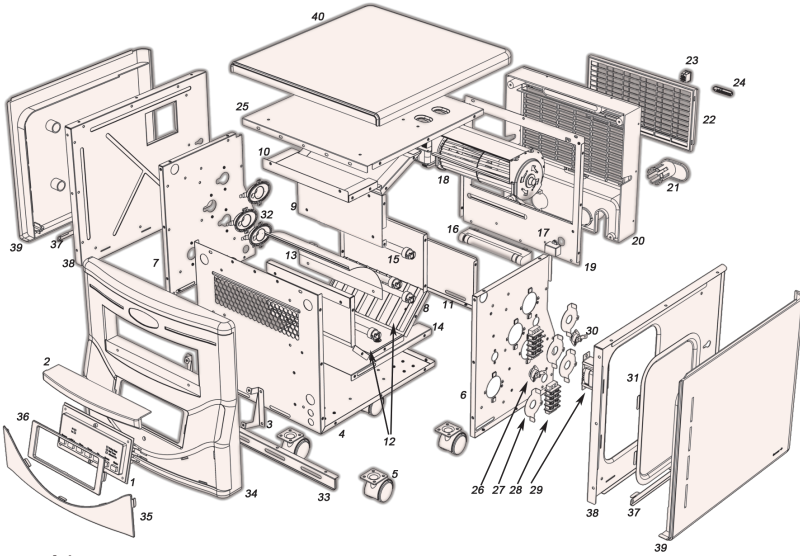

Parts List

- | | |
|-------------------------------|-----------------------------|
| 1. Control Panel | 21. Power Cord Release |
| 2. Register Trim Piece | 22. Electrostatic Filter |
| 3. Control Panel Support (x2) | 23. UV and Ionizer switch |
| 4. Main Sheet Metal Body | 24. Temp Sensor Cover |
| 5. Caster Wheel (x4) | 25. Top Sheet Metal Panel |
| 6. Heat Exchanger Right Side | 26. Temp Sensor |
| 7. Heat Exchanger Left Side | 27. IR Bulb Cover (x4) |
| 8. Heat Exchanger Bottom | 28. Terminal Block (x2) |
| 9. Heat Exchanger Divider | 29. Transformer |
| 10. Heat Exchanger Top | 30. High Limit Switch |
| 11. heat Exchanger Back | 31. IR Bulb Access Cover |
| 12. Copper Plate (x2) | 32. IR Bulb Socket (x4) |
| 13. Copper Baffle | 33. Cover Sealer |
| 14. Heat Blanket Support | 34. Front Plastic Cover |
| 15. Infrared Bulb (x4) | 35. Main Trim Piece |
| 16. UV Bulb | 36. Control Panel Trim |
| 17. Ionizer | 37. Plastic Cover Rail (x2) |
| 18. Cross Flow Fan | 38. Metal Side Panel |
| 19. Rear Sheet Metal Panel | 39. Plastic Side Panel |
| 20. Rear Plastic Cover | 40. Plastic Top Panel |

BioSmart® Heater Schematic

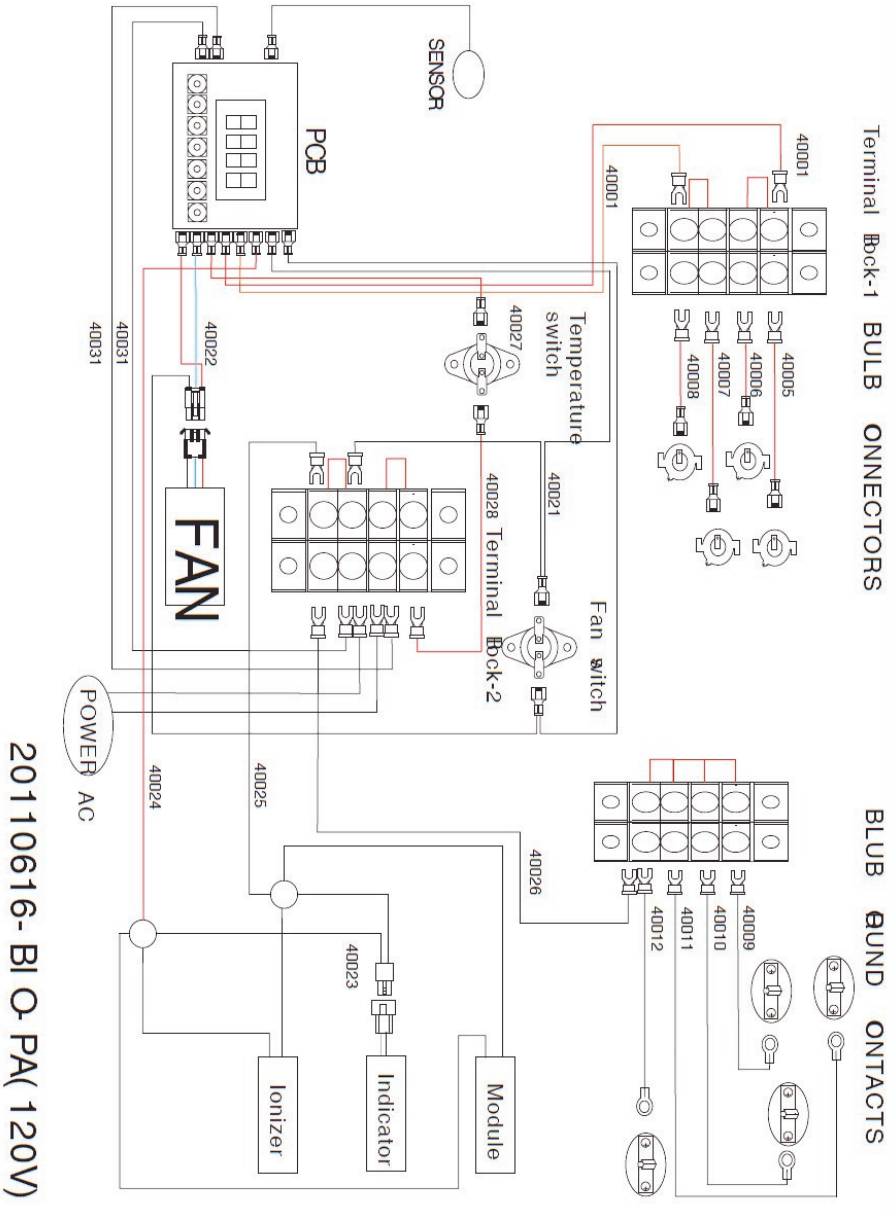

20110616- BI O- PA (120V)

Warranty & Service Information

Three-Year Limited Warranty

BIOSMART TECHNOLOGIES (BT) warrants this product, to the original purchaser or gift recipient, to be free from defects in workmanship and materials under normal use and service, for a period of one year from the date of purchase. BT further warrants the infrared heating elements and fan motors, to the original purchaser or gift recipient, for a period of two additional years from the date of purchase.

Extended Warranty Details: For an additional two-year period, BT shall warrant the infrared elements and fan motors in the heater to be free from defects in workmanship and materials under normal use and service, and shall supply at no cost, excluding shipping, to the original purchaser replacement elements or fans as required to maintain product in good working order.

Shipping: BT or its Dealer shall bear the cost of return shipping and repair, or replacement if, during the first 90 days, there is a defect in workmanship or materials. Thereafter, customer shall bear the cost of return shipping and BT shall repair or replace any defective part including all labor for a period of one full year from the date of purchase.

Limitations

ALL WARRANTIES IMPLIED BY LAW, INCLUDING THE IMPLIED WARRANTIES OF MERCHANTABILITY AND FITNESS FOR A PARTICULAR PURPOSE, ARE EXPRESSLY LIMITED TO THE DURATION OF THE WARRANTY SET FORTH ABOVE.

Some jurisdictions do not allow limitations on the length of the implied warranty, so the above limitation may not apply to you.

IN NO EVENT SHALL BT BE LIABLE FOR ANY INCIDENTAL OR CONSEQUENTIAL DAMAGES, LOSS OF PROFIT, OR MEDICAL EXPENSES CAUSED BY ANY DEFECT, FAILURE, MISUSE, OR MALFUNCTION OF THE PRODUCT.

Note: Some jurisdictions do not allow the exclusion of limitation of incidental or consequential damages, so the above limitation or exclusion may not apply to you.

The Company will not be responsible for the damages or losses, direct or indirect, caused by misuse, abuse, accident, negligence, conditions of transportation or storage, or failure to follow instructions. The Company will not be responsible for any statements that are made or published, written or oral, that are inconsistent with this written warranty, or which are misleading or inconsistent with the facts as published in the literature or specifications by the Company.

Warranty Restriction

This warranty is invalid if the factory-applied serial number has been altered or removed from the product.

Warranty Claim Procedure

To obtain warranty service, you must:

- **Contact the Dealer** you purchased your equipment from for additional instruction.
- **Provide proof of purchase**, if requested, in the form of a Bill of Sale or receipted invoice to show evidence that the unit is within the warranty period.

Bio Smart® Far Infrared Heaters
Green Technology for a Modern World

North American Distribution and Sales

Bio Smart
Technologies

18324 Cook Road, Suite 1
Yelm, Washington 98597
Customer/Warranty Service:
800-595-9605

Bio Smart® Far Infrared Heaters by Bio Smart Technologies