

The Bullard 88VX Series airline respirators, when properly used, provide a continuous flow of air from a remote air source to the respirator wearer. 88VX Series respirators offer protection from airborne contaminants that are not immediately dangerous to life or health (IDLH), or that do not exceed concentrations allowed by applicable OSHA, EPA, NIOSH, ACGIH, or other regulatory standards and recommendations.

88VX Series airline respirators are approved by NIOSH (TC-19C-0293 Type C and CE) to provide respiratory protection in general purpose applications including heavy- and light-duty abrasive blasting, and Type C and CE painting applications. The protective helmet meets ANSI/ISEA Standard Z89.1 Type 1 requirements for protective headwear for industrial workers, and ANSI/ISEA standard Z87.1, Z87+ High-Impact Face Protection. The cape is designed to protect the worker's body from abrasive rebound.

88VX Series respirators are compatible with breathing air sources such as breathing air compressors or Bullard Free-Air Pumps. Bullard offers the appropriate approved breathing tube assembly and air supply hose to connect the 88VX Series respirator to these breathing air sources.

88VX Series respirators are approved by NIOSH for use with optional climate control devices offered by Bullard.

## NOTE

For technical assistance or questions contact Bullard Customer Service at:  
Toll-Free 877-BULLARD (285-5273) or 859-234-6616  
Online at [www.bullard.com](http://www.bullard.com) or e-mail [info@bullard.com](mailto:info@bullard.com)

## Cautions and Limitations

### For 88VX Series Supplied Air Respirators

- A. Not for use in atmospheres containing less than 19.5% oxygen.
- B. Not for use in atmospheres immediately dangerous to life or health (IDLH). IDLH is defined in 29 CFR 1910.134(b).
- C. Do not exceed maximum use concentrations established by regulatory standards.
- D. Airline respirators can be used only when respirators are supplied with respirable air meeting the requirements of CGAG-7.1 Grade D or higher quality.
- E. Use only the pressure ranges and hose lengths specified in this User Manual.

- J. Failure to properly use and maintain this product could result in injury or death.
- M. All approved respirators shall be selected, fitted, used, and maintained in accordance with MSHA, OSHA, and other applicable regulations.
- N. Never substitute, modify, add, or omit parts. Use only exact replacement parts in the configuration as specified by the manufacturer.
- O. Refer to user's instructions, and/or maintenance manuals for information on use and maintenance of these respirators.
- S. Special or Critical User's Instructions and/or specific use limitations apply. Refer to User's Instructions before donning.

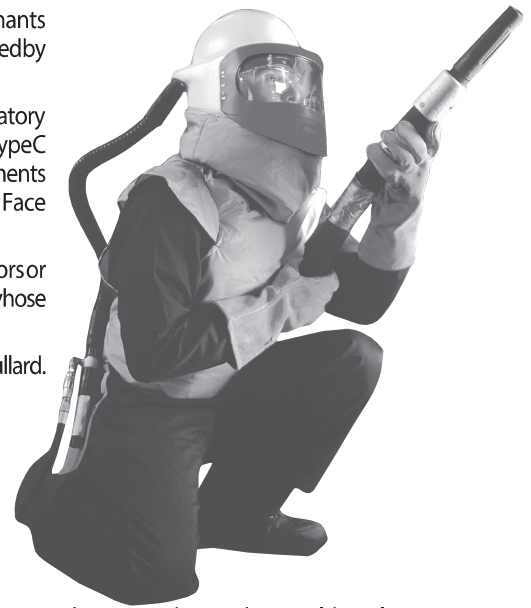

## Table of Contents

Introduction .....	2-3
Approval Label .....	4-5
Component Concept .....	6
Warnings .....	7-8
Cautions/Limitations.....	8
Operations	
Protection .....	8
Breathing Air Requirements .....	8-9
Breathing Air Pressure .....	9
Breathing Air Pressure Tables .....	10
Typical Breathing Air Source and Respirator Configurations ...	11
Respirator Assembly	
Sizing the Headband .....	12
Installing Headband into Inner Shell .....	13
Attaching Cape to Helmet .....	13
Installing Breathing Tube Assembly into Respirator Helmet ...	13
Using Climate Control Devices .....	13
Respirator Use	
Donning .....	14
Doffing .....	14

Inspection, Cleaning, and Storage	
Cape .....	15
Headband and Chin Strap .....	15
Helmet .....	15
Lenses and Window Frame Gasket .....	15
Breathing Tube Assembly .....	16
Air Supply Hoses .....	16
Storage .....	16
Parts and Accessories for 88VX Series	
Airline Respirators .....	17-19
AC1000 Cool Climate Control Tube .....	20
HC2400 Hot/Cold Climate Control Tube .....	21-22
DC50 Series Dual-Cool Climate Control Tube/ DC70 Vest .....	23-24
Frigitron 2000 Cool Climate Control Tube .....	25
V10 Breathing Air Supply Hose and V20 Supply Hose .....	26-27
Warranty .....	28
Return Authorization .....	28

## WARNING

Read all instructions and warnings before using this respirator. Save this manual for future reference. Failure to follow these instructions could result in death or serious injury.



- 
- 1) Read all warnings and instructions prior to using this respirator. Improper respirator use may result in serious injury and/or death. Improper use may also cause certain life-threatening delayed lung diseases such as silicosis, pneumoconiosis, or asbestosis. Respirators shall be selected, fitted, used and maintained in accordance with MSHA, OSHA, NIOSH and other applicable regulations.
  - 2) Do not use this respirator if any of the following conditions exist:
    - The atmosphere is immediately dangerous to life or health (IDLH) as defined in 21 CFR 1910.134(b).
    - You cannot escape without the aid of the respirator
    - The atmosphere contains less than 19.5% oxygen
    - The work area is poorly ventilated
    - Unknown contaminants are present
    - Contaminant concentrations are unknown or in excess of maximum use concentrations for this respirator.
  - 3) Leave the work area immediately if:
    - Any respirator component becomes damaged
    - Airflow into respirator stops or slows down
    - The air pressure, as indicated on the gauge, drops below the minimum specified in the Breathing Air Pressure Table in the 88VX Series User Manual
    - Breathing becomes difficult
    - You become dizzy, nauseous, too hot, too cold, or ill
    - You taste, smell, or see contaminants inside the respirator hood
    - Your vision becomes impaired
  - 4) Always leave the contaminated area before reaching into the helmet or doffing the respirator.
  - 5) It is imperative to know the level of concentration of contaminants for which this respirator, or any respirator, is being used in order to select an appropriate respirator. If this respirator is used in sand blasting, it is necessary to regularly monitor the concentrations outside the respirator during the blasting operations.
  - 6) It is imperative to measure the concentration of the contaminants after the blasting stops before reentering the area. Concentrations may still be high enough to exceed the maximum use concentrations of many respirators, including supplied air respirators.
  - 7) Do not assume that the concentrations you measured at an earlier time or location are the same for a different task or operation. Concentrations may vary significantly depending on factors including, but not limited to, the number of blasters engaged in the operation, whether the blasting is in an enclosed or partially-enclosed structure (confined or semi-confined space), whether ventilation is used, and the type of ventilation.
  - 8) This respirator, when properly fitted and used, in conjunction with adherence to OSHA regulations and industry standards, will provide a reasonable degree of protection to the wearer. The respirator significantly reduces, but may not totally eliminate, the breathing of contaminants depending on the work practices involved. Where concentrations of contaminants exceed the protective rating of this respirator, a higher level of protection such as a self-contained breathing apparatus (SCBA) respirator may be required. Ideally, the employer should measure concentrations inside the breathing zone on a periodic basis to ensure that the wearer is receiving adequate protection.
  - 9) Do not wear this respirator until you have passed a complete medical evaluation (perhaps including a lung x-ray) conducted by qualified medical personnel, and have been trained in the respirator's use, maintenance, and limitations by a qualified individual (appointed by your employer) who has extensive knowledge of Bullard 88VX Series respirators.
  - 10) Do not modify or alter this respirator in any manner. Use only 88VX Series components and replacement parts manufactured by Bullard for use with this respirator. Failure to use Bullard components and replacement parts such as lenses, hoses, flow control devices, capes, and climate control devices, voids NIOSH approval of the entire respirator, invalidates all Bullard warranties, and could cause death, serious injury, lung disease, or exposure to other hazardous or life threatening conditions.

# 88VX Series Airline Respirator User Manual

---

- 11) Inspect all components of this respirator system daily for signs of wear, tear, or damage that might reduce the degree of protection originally provided. Immediately replace worn or damaged components with Bullard 88VX Series components or remove the respirator from service.
- 12) This respirator must be supplied with clean breathable air at all times. The breathing air source at the point-of-attachment must provide at least Grade D breathable air as described in the Compressed Gas Association Commodity Specification CGAG-7.1 and as specified by Federal Law at 42 CFR, Par 84, Subpart J, 84.141(b) and 29 CFR 1910.134(i). The point-of-attachment is the point at which the air supply hose connects to the air source. This respirator does not purify air or filter out contaminants.
- 13) Do not connect the respirator's air supply hose to nitrogen, oxygen, toxic gases, inert gases, or other non-Grade D air sources. To prevent this, use airline couplings that are incompatible with outlets for other gas systems, as required by OSHA regulation 29 CFR 1910.134(i)(8). Check the air source before using the respirator. Failure to connect to the proper air source could result in death or serious injury.
- 14) Use only the hose lengths and pressure ranges specified in the instruction manual. A pressure gauge attached to the air source is used to monitor the amount and adequacy of air provided to the respirator wearer.
- 15) Do not use this respirator in poorly ventilated areas or confined spaces such as tanks, small rooms, tunnels, or vessels unless the confined space is well ventilated and the contaminant concentrations are below the maximum user recommended for this respirator. In addition, follow all procedures for confined space entry, operation and exit as defined in applicable regulations and standards, including 29 CFR 1910.146.
- 16) Historically, the incidence of disease from overexposure to toxic substances almost always occurs because the OSHA regulations and industry standards applicable to the work practices involved are not followed. It is, therefore, imperative that the employer understand and follow all of these standards and regulations.

## REMEMBER:

- Respiratory protection is but one component of safe work practices. To minimize the chances of overexposure, all safety regulations and standards must be followed; and,
- Respiratory protection is the last line of defense to be employed. The employer must first eliminate or minimize the levels of toxic substances in the workplace by accepted engineering control measures. Assuming the employer and the wearer do their part, this respirator should provide the wearer with an adequate degree of protection.



# 88VX Series Airline Respirator User Manual



COMPONENTS		ALTERNATE AIR HOSES	ALTERNATE AIRLINE FITTINGS	ALTERNATE LENSES	ALTERNATE BELTS	ACCESSORIES	CAUTIONS/ LIMITATIONS*
X	HC240031						
X	HC240032						
X	HC240033						
X	HC240034						
X	HC240037						
X	HC240038						
X	54515						
X	54514						
X	54513						
X	54512						
X	54511						
X	54510						
X	5454						
X	5457						
X	5458						
X	46919						
X	46918						
X	46917						
X	46916						
X	46915						
X	46913						
X	4696						
X	469650						
X	4696100						
X	V20505T						
X	V201005T						
X	V11						
X	V12						
X	V13						
X	V14						
X	V18						
X	V19						
X	V198						
X	V37						
X	V38						
X	V17						
X	S19432						
X	S19442						
X	S19443						
X	3902						
X	S19448						
X	771R						
X	771D						
X	771R020						
X	77-1-040						
X	77-1-020						
X	88VX0LG						
X	88VXOLT						
X	88VXLC						
X	7714						
X	36501						
X	4612						
X	GVXCP						
X	20NC						
X	DC70ML						
X	DC70LXXL						
X	DC705X						
X	88CS						
							ABCDEFGHIJMNOS

## Component Concept

The Bullard 88VX Series airline respirators consist of three components (Figure 1): respirator helmet assembly, breathing tube assembly, and air supply hose. All components must be present and properly assembled to constitute a complete NIOSH approved respirator.

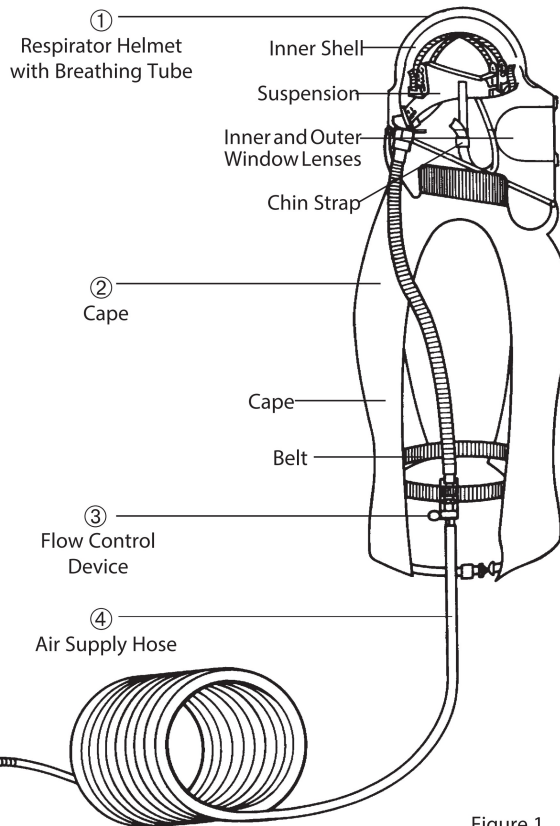

Supplying Grade "D" or Higher Air Quality  
(See Breathing Air Requirements on page 6-7)

Figure 1

**⚠ WARNING**

Failure to use complete Bullard components and replacement parts voids approval of entire assembly. Basic parts are listed on the NIOSH Approval Label on page 4-5. Failure to follow these instructions could result in death or serious injury.

# 88VX Series Airline Respirator User Manual

## WARNING

1. This respirator, when properly fitted and used, in conjunction with adherence to OSHA regulations and industry standards, will provide a reasonable degree of protection to the wearer. The respirator significantly reduces, but may not totally eliminate, the breathing of contaminants depending on the work practices involved. Where concentrations of contaminants are excessive, respirator wearers may obtain a higher level of protection from a valve-operated, pressuredemand airline respirator or a pressuredemand, self-contained breathing apparatus (SCBA) respirator. At this time there are no side-by-side field studies for comparison. However, OSHA does assign higher protection factors to these groups of respirators. Ideally, the employers should measure concentrations inside the breathing zone on a periodic basis to ensure that the wearer is receiving adequate protection.
  2. Before using this respirator, Federal Law requires that the employers shall identify and evaluate the respiratory hazard(s) in the workplace, and that this evaluation shall include a reasonable estimate of employee exposure to respiratory hazard(s) and an identification of the contaminant's chemical state and physical form. Do not exceed maximum use concentrations established by OSHA, EPA, NIOSH, ACGIH, or other regulatory standards.
  3. Improper respirator use may damage your health and/or cause your death. Improper use may also cause certain life-threatening delayed lung diseases such as silicosis, pneumoconiosis, or asbestosis.
  4. DO NOT wear this respirator if any of the following conditions exist:
    - Atmosphere is immediately dangerous to your life or health (IDLH),
    - You CANNOT escape without the aid of the respirator,
    - Atmosphere contains less than 19.5% oxygen,
    - Work area is poorly ventilated,
    - Unknown contaminants are present, or
    - Contaminant concentrations are in excess of regulations or recommendations (as described in item 2 above).
  5. DO NOT wear this respirator until you have passed a complete medical evaluation (perhaps including a lung x-ray) conducted by qualified medical personnel, and have been trained in the respirator's use, maintenance, and limitations by a qualified individual (appointed by your employer) who has extensive knowledge of Bullard 88VX Series respirators.
  6. DO NOT modify or alter this respirator in any manner. Use only 88VX Series components and replacement parts manufactured by Bullard for use with this respirator.

Failure to use Bullard components and replacement parts such as lenses, hoses, flow control devices, capes, and climate control devices, voids NIOSH approval of the entire respirator, invalidates all Bullard warranties, and could cause death, serious injury, lung disease, or exposure to other hazardous or life-threatening conditions.
  7. Inspect all components of this respirator system daily for signs of wear, tear, or damage that might reduce the degree of protection originally provided. Immediately replace worn or damaged components with Bullard 88VX Series components or remove the respirator from service. (See INSPECTION, CLEANING, AND STORAGE section on pages 15-16 for proper maintenance of 88VX Series respirators.)
  8. Be certain your employer has determined that the breathing air source provides at least Grade D breathable air. This respirator must be supplied with clean breathable air at all times.
  9. Do not connect the respirator's air supply hose to nitrogen, oxygen, toxic gases, inert gases, or other unbreathable, non-Grade D air sources. To prevent this, the employers shall use airline couplings used for this respirator that shall be incompatible with outlets for other gas systems, as required by OSHA regulation 29 CFR 1910.134(i)(8). Check the air source before using the respirator. Failure to connect to the proper air source could result in death or serious injury.
  10. Do not use this respirator in poorly ventilated areas or confined spaces such as tanks, small rooms, tunnels, or vessels unless the confined space is well ventilated and the contaminant concentrations are below the upper limit recommended for this respirator. In addition, follow all procedures for confined space entry, operation and exit as defined in applicable regulations and standards, including 29 CFR 1910.146.
  11. If you have any questions concerning the use of this respirator, or if you are not sure whether the atmosphere you are working in is immediately dangerous to life or health (IDLH), ask your employer. All instructions for the use and care of this product must be supplied to you by your employer as recommended by the manufacturer and as required by Federal Law (29 CFR 1910.134).
  12. Do not use this respirator for underwater diving.
  13. Leave work area immediately if:
    - Any respirator component becomes damaged.
    - Airflow into respirator stops or slows down.
    -
- Air pressure gauge drops below the minimum specified in the Breathing Air Pressure Table in the 88VX Series User Manual.
- Breathing becomes difficult.
  - You become dizzy, nauseous, too hot, too cold, or ill.
  - You taste, smell, or see contaminants inside the respirator hood.
  - Your vision becomes impaired.

(Continued on Page 8)

(Continued from Page 7)

**⚠ WARNING**

14. Historically, the incidence of disease from overexposure to toxic substances almost always occurs because the OSHA regulations and industry standards applicable to the work practices involved are not followed. It is, therefore, imperative that the employer acquaint itself with and follow all of these standards and regulations. **REMEMBER:**

- Respiratory protection is but one component of safe work practices. To minimize the chances of overexposure, all safety regulations and standards must be followed; and
- Respiratory protection is the last line of defense to be employed. The employer must first eliminate or minimize the level of toxic substances in the workplace by accepted engineering control measures. Assuming that the employer and the wearer do their part, this respirator should provide the wearer with an adequate degree of protection.

## Cautions and Limitations

- A. Not for use in atmospheres containing less than 19.5 percent oxygen.
  - B. Not for use in atmospheres immediately dangerous to life or health.
  - C. Do not exceed maximum use concentrations established by regulatory standards.
  - D. Airline respirators can be used only when respirators are supplied with respirable air meeting the requirements of CGAG-7.1 Grade D or higher quality.
  - E. Use only the pressure ranges and hose lengths specified in the instruction manual.
  - J. Failure to properly use and maintain this product could result in death or serious injury.
  - M. All approved respirators shall be selected, fitted, used, and maintained in accordance with MSHA, OSHA, and other applicable regulations.
  - N. Never substitute, modify, add, or omit parts. Use only exact replacement parts in the configuration as specified by the manufacturer.
  - O. Refer to users instructions, and/or maintenance manuals for information on use and maintenance of these respirators.
  - S. Special or critical User's Instruction and/or specific use limitations apply. Refer to User's Instructions before donning.
- For technical assistance call or write:

Bullard  
 1898 Safety Way  
 Cynthiana, KY 41031-9303  
 Toll free: 877-BULLARD (285-5273)  
 Phone: 859-234-6616  
 Fax: 859-234-8987

## Operations Protection

**Respiratory**  
 This respirator is NIOSH approved (TC-19C-0293) as a Type C and CE respirator. It can be worn for general purpose applications, including heavy and light-duty abrasive blasting, and spray painting.

This respirator is not approved for use in any atmosphere immediately dangerous to life or health (IDLH), or from which the wearer cannot escape without the aid of the respirator.

**Head**  
 88VX Series respirators meet ANSI Standard Z89.1 Type 1 Class C requirements for protective headwear for industrial workers. The helmet is designed to provide limited head protection by reducing the force of falling objects striking the top of the helmet.

### Face

The tandem use of the respirator's inner and outer windows meet ANSI Z87.1 (High impact plus Z87 + Face Protection) requirements for face protection. The use of both windows provide limited face protection from flying particles or spray of hazardous liquids, but is not shatterproof. There is no need to apply Anti-Fog to these lenses.

### Eyes

88VX Series respirators **DONOT** provide eye protection. Wear approved safety glasses or goggles at all times.

### Ears

88VX Series respirators **DONOT** provide hearing protection. Use properly fitted ear muffs, earplugs or other protection when exposed to high noise levels.

## Breathing Air Requirements

### Air Quality

Respirable, breathing air must be supplied to the point-of-attachment of the approved Bullard air supply hose. The point-of-attachment is the point at which the air supply hose connects to the air source. A pressure gauge attached to the air source is used to monitor the pressure of air provided to the respirator wearer (Figure 2, Page 8, and Figure 3, Page 11).

**⚠ WARNING**

This respirator **MUST** be supplied with clean, breathable air, Grade D or better, at all times. This respirator does **NOT** purify air or filter out contaminants. Failure to follow these instructions could result in death or serious injury.

Supplied breathing air must **AT LEAST** meet the requirements for Type 1 gaseous air as described in the Compressed Gas Association Commodity Specification G-7.1 (Grade D or higher quality), and as specified by Federal Law 42 CFR, Part 84, Subpart J, 84.141 (b) and 29 CFR 1910.134(i).

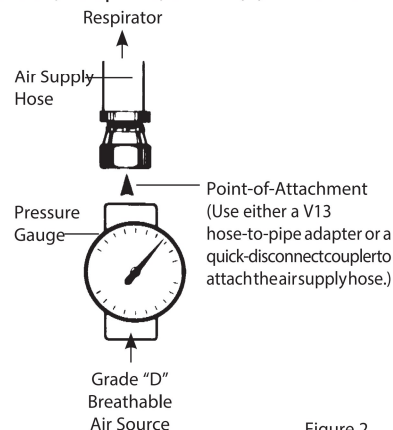

Figure 2

# 88VX Series Airline Respirator User Manual

The requirements for Grade D breathable air include:

- Oxygen ..... 19.5-23.5%
- Hydrocarbons (condensed)  
in mg/m3 ..... 5 mg/m3 max.
- Carbon monoxide ..... 10 ppm max.
- Carbon dioxide..... 1,000 ppm max.
- Odor .....Lack of noticeable odor
- No toxic contaminants at levels that make the air unsafe to breathe.

Contact the Compressed Gas Association (1725 Jefferson Davis Hwy, Arlington, VA 22202) for completed detail on Commodity Specification G-7.1.

## Air Source

Locate the source of supplied air whether it is an air compressor or an ambient air pump, such as a Bullard Free-Air pump, in a clean air environment. Locate the air source far enough from your work site to ensure the air remains contaminant-free. Always use an inlet filter on your air source.

Use suitable after-cooler/dryers, filters, carbon monoxide monitors and alarms, like the Bullard Clean Air Box (CAB) Series, as necessary to assure clean, breathable air at all times.

The air should be regularly sampled to be sure that it meets Grade D requirements.

## Breathing Air Pressure

Air pressure must be continually monitored at the point-of-attachment while operating this respirator. A reliable air pressure gauge must be present to permit you to continually monitor the pressure during actual respirator operation.

### WARNING

Failure to supply the minimum required pressure at the point-of-attachment for your hose length and type will reduce air flow and could result in death or serious injury.

The Breathing Air Pressure Table (page 10) defines the air pressure ranges necessary to provide 88VX Series respirators with a volume of air that falls within the required range of 6-15 cfm or 170-425 lpm (Ref. 42 CFR, Part 84, Subpart J, Table 8).

Make sure you understand the information in the Breathing Air Pressure Table before using this respirator.

1. Determine the type of air source you are using, then find your flow control valve/climate control device (columns 1, 2, 3, and 4).
2. Be sure your Bullard air supply hose(s) (columns 5 through 12) is approved for use with your flow control valve/climate control device.
3. Determine that your Bullard air supply hose is within the approved length (columns 5 through 12).
4. Make sure you have not exceeded the maximum number of hose sections (columns 5 through 12).
5. Set the air pressure at the point-of-attachment within the required pressure range (columns 5 through 12) for your flow control valve/climate control device, and air supply hose type and length. Accurate pressure readings can only be attained when air is flowing into the respirator.

Bullard air supply hose(s) MUST be used between the breathing tube connection fitting on the wearer's belt and the point-of-attachment to the air supply (Figure 3, Page 11).

Bullard quick-disconnect fittings MUST be used to connect V20 hose lengths together. When connecting lengths of V10 hose, only use Bullard V11 hose-to-hose adapters. Secure connection(s) until wrench tight and leak free. Total connected hose length and number of hoses MUST be within the ranges specified on the Breathing Air Pressure Table (Page 10) and the respirator's NIOSH approval label (Page 4-5).

The breathing tube connection fitting MUST be secured to the belt that is supplied with this respirator. Securing the air entry connection fitting helps prevent the air supply hose from snagging, disconnecting or pulling the respirator helmet off your head.



### Special or Critical User's Instructions

The 88VX Series Breathing Air Pressure Table defines the air pressure ranges necessary to provide 88VX Series respirators with a volume of air that falls within the required range of 6-15 cfm or 170-425 lpm (42 CFR, Part 84, Subpart J, 84.150).

**⚠ WARNING**

Failure to supply the minimum required pressure at the point-of-attachment for your hose length and 88VX respirator type will reduce airflow and could result in death or serious injury.

To use the table and identify the proper air flow range; 1) select the air source (Compressed Air), 2) the use mode, 3) the exact part number of the flow control device; and 4) the length of the air supply hose. Note the maximum hose segments that are approved. Only use or select a configuration that is specified and has a pressure range provided.

## 88VX Series Respirator Breathing Air Pressure Table

		V10 Hose										
Air Source	Usage	Flow Control Device Part Number	Coupling Design	25' Max 1 Hose Length	50' Max 2 Hose Lengths	75' Max 3 Hose Lengths	100' Max 3 Hose Lengths	150' Max 3 Hose Lengths	200' Max 5 Hose Lengths	250' Max 5 Hose Lengths	300' Max 5 Hose Lengths	
Compressed Air	Constant Flow	F30/F30B/F30S	Ind. Interchange	19-25	22-28	24-31	26-33	31-38	34-46	39-47	42-55	
		F31	Schrader	16-22	20-25	22-28	24-30	29-36	32-44	37-43	40-53	
		F32/F33/F34*	Snap-Tite	14-19	18-22	21-26	22-28	27-34	31-42	36-41	39-52	
		F37	CEJN	9-12	14-16	18-21	19-24	25-30	29-40	35-39	38-49	
		F38	Bayonet	23-31	25-32	28-35	29-37	34-42	37-50	42-49	45-58	
	Adjustable Flow	F40/F40B/F40S	Ind. Interchange	29-30	32-33	33-36	35-38	39-43	42-50	46-50	48-58	
		F41	Schrader	26-30	29-32	31-35	32-37	36-42	39-49	43-48	46-57	
		F42/F43/F44	Snap-Tite	26-26	29-29	32-32	33-35	36-39	39-47	43-47	47-56	
		F47	CEJN	21-21	24-24	27-28	29-31	33-36	36-44	41-44	44-54	
		F48	Bayonet	29-36	32-38	34-41	34-43	39-47	41-54	46-54	50-62	
	Cooling Mode	AC100030/AC100030B/AC100030S	Ind. Interchange	65-67	68-69	69-71	71-72	74-75	76-80	81-81	83-86	
		AC100031	Schrader	67-69	69-71	71-72	73-74	76-77	78-82	82-82	85-88	
		AC100032/AC100033/AC100034	Snap-Tite	66-68	69-70	71-71	72-74	75-76	77-82	82-82	85-88	
		AC100037	CEJN	64-66	65-67	69-70	70-71	75-75	76-80	80-80	84-86	
		AC100038	Bayonet	68-69	68-70	72-72	72-73	76-76	78-82	83-83	86-88	
		DC5040/DC5040B/DC5040S	Ind. Interchange	70-70	74-74	78-78	84-84	92-92	99-101	110-110	115-115	
		DC5041	Schrader	67-67	74-74	78-78	81-81	90-90	97-100	106-106	114-114	
		DC5042/DC5043/DC5044	Snap-Tite	61-61	68-76	73-82	76-86	84-96	91-111	102-111	108-125	
		DC5047	CEJN	52-55	60-61	68-68	71-72	81-82	89-97	100-100	107-114	
		DC5048	Bayonet	77-77	73-80	87-87	89-89	99-99	104-107	114-114	121-121	
		HC240030/HC240030B/HC240030S	Ind. Interchange	71-71	73-73	75-75	77-77	81-81	84-87	90-90	94-96	
		HC240031	Schrader	66-67	70-70	71-72	74-74	79-79	81-85	87-87	90-93	
		HC240032/HC240033/HC340034	Snap-Tite	67-68	71-71	73-73	75-75	79-79	82-86	87-87	91-95	
		HC240037	CEJN	62-63	65-65	69-69	71-71	76-76	78-82	85-85	88-91	
		HC240038	Bayonet	72-73	75-75	76-77	78-78	82-83	86-89	91-91	95-99	
	Heating Mode	HC240030/HC240030B/HC240030S	Ind. Interchange	78-78	79-80	80-82	83-84	87-88	91-95	97-97	99-102	
		HC240031	Schrader	73-75	76-77	77-79	80-81	85-86	87-92	94-94	97-100	
		HC240032/HC240033/HC340034	Snap-Tite	72-75	77-79	79-80	81-83	85-86	88-93	93-93	98-102	
		HC240037	CEJN	67-71	70-73	74-76	75-78	81-83	85-90	90-90	94-98	
			HC240038	Bayonet	78-81	79-82	83-85	83-86	89-91	92-97	98-98	102-106

		V20 Hose									
Air Source	Usage	Part Number		25' Hose Length	50' Max 1 Hose Length	75' Hose Length	100' Max 1 Hose Length	150' Hose Length	200' Max 2 Hose Lengths	250' Hose Length	300' Max 3 Hose Lengths
Compressed Air	Constant Flow	F35/F35B/F35S	Industrial Interchange	Not Applicable	7-9	Not Applicable	9-12	Not Applicable	13-17	Not Applicable	16-21
	Cooling	FRIGITRON2000/ FRIGITRON2000B/FRIGITRON2000S	Industrial Interchange	Not Applicable	21-23	Not Applicable	23-25	Not Applicable	27-28	Not Applicable	30-31

# 88VX Series Airline Respirator User Manual

## Typical Breathing Air Source and Respirator Configurations (Figure 3)

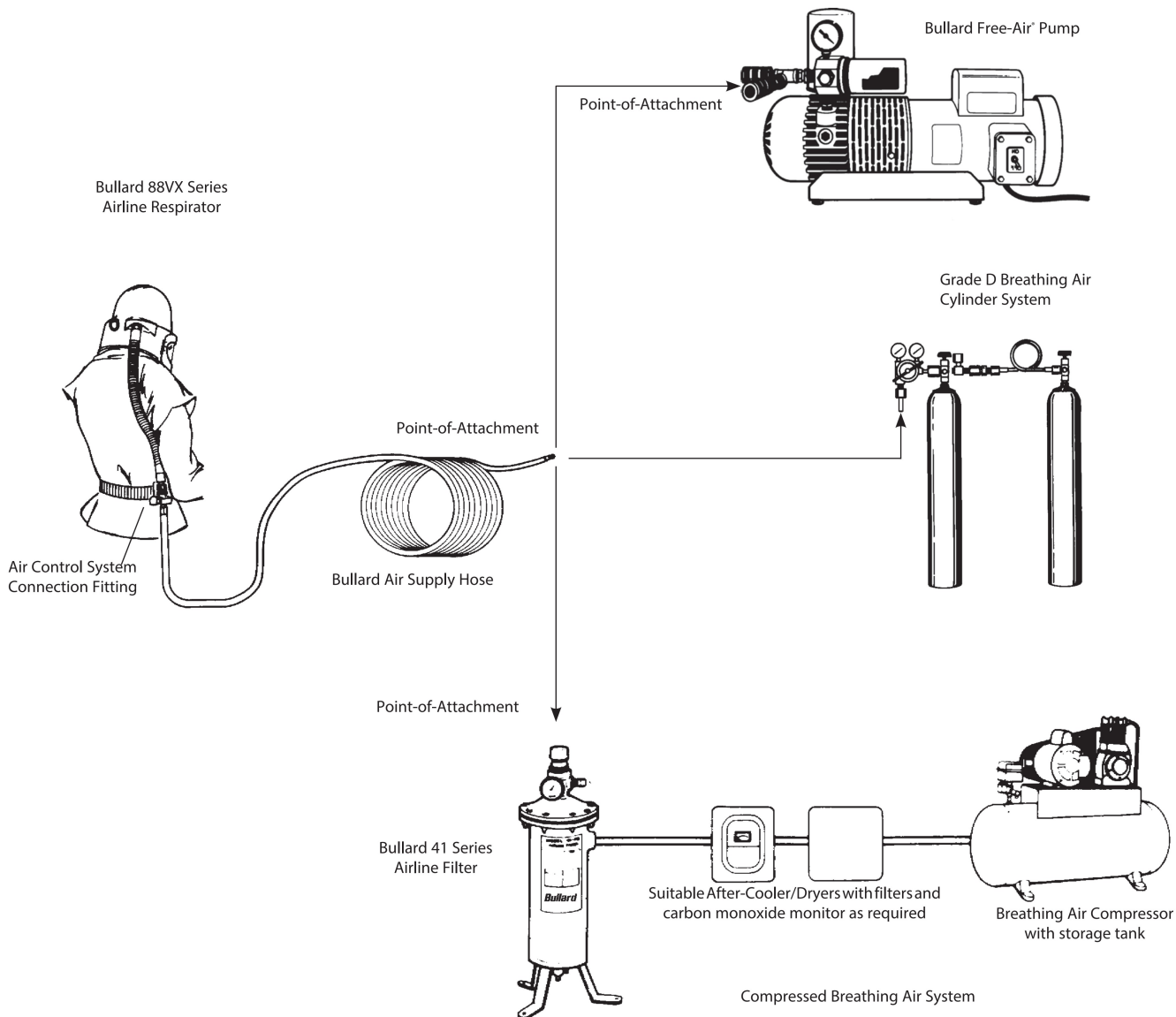

**Point-of-Attachment**  
The point-of-attachment is the point at which the air supply hose connects to the air source. A pressure gauge attached to the air source is used to monitor the pressure of air provided to the respirator wearer.

## Respirator Assembly

Before assembling this respirator, read the warning labels on the inside of the respirator cape and the helmet shell and this manual in full.

Remove and read the warning card inserted between the respirator's two lenses.

### Sizing the Headband

Before you can size the headband suspension, the cape and headband must be removed from the helmet using the following steps:

1. Open hinged window frame by lifting up on window latch.
2. Remove cape from helmet by lifting up on clamp and disengaging cape from helmet groove (Figure 4).
3. Turn helmet upside down. To remove inner shell from helmet, hook index finger into loop on back of inner shell. Press thumb against helmet rim and pull loop toward front of helmet, then pull up and away from helmet (Figure 5). This releases inner shell.
4. To change the headband size, first determine whether you have a pinlock or ratchet headband.

For pinlock headbands, unlock the four pins from the sizing holes. Place the headband on your head. Pull down, allowing headband to expand until it feels comfortable. The headband will automatically adjust to your size. Lock into place by pushing the four pins into the sizing holes (Figure 6a).

To size a ratchet headband, turn ratchet knob until headband is at its largest size. Place suspension on your head and adjust ratchet knob to a comfortable fit (Figure 6b). An optional chin strap is available for additional comfort and stability.

5. Remove headband from your head.

### Adjust Crown Straps for Vertical Fit

To improve suspension comfort, adjust crown straps vertically by repositioning the crown strap posts in the crown straps. Vertical adjustment makes the headband ride higher or lower on the wearer's head. To adjust, push crown strap post from slot, move to new slot, and snap in to secure. Move key to desired vertical position. Repeat for other crown strap post (Figure 7).

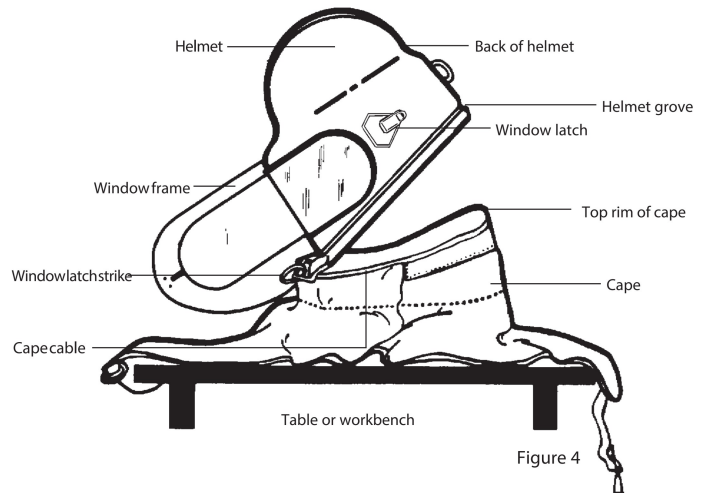

Figure 4

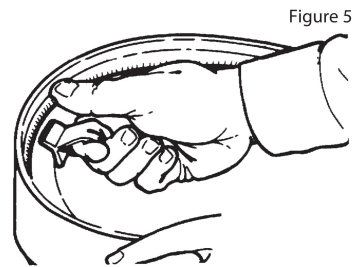

Figure 5

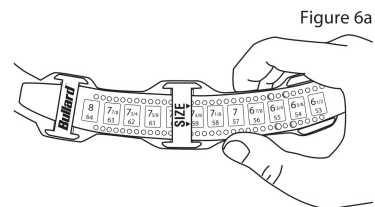

Figure 6a

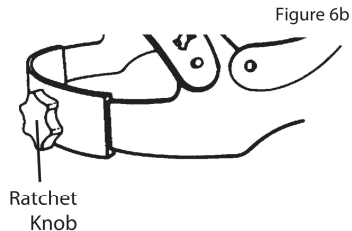

Figure 6b

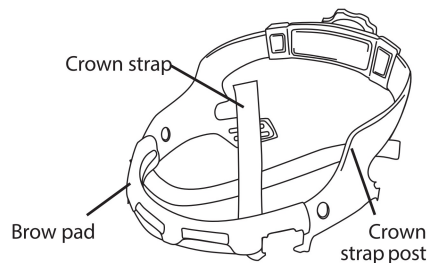

Figure 7

# 88VX Series Airline Respirator User Manual

## Installing Headband into Inner Shell

1. Turn inner shell and headband suspension upside down.
2. Place headband inside shell with brow pad facing front of shell.
3. Insert keys into respective key slots. Push firmly until keys snap into place (Figure 8).

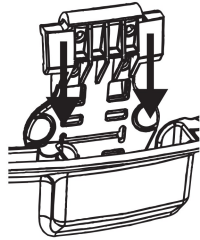

Figure 8

4. Insert inner shell into helmet with front of shell tilted down. Align round hole located at front of shell with washer at inside front of helmet. Press back of shell into helmet until it snaps in place.

### Using the 20NC Chin Strap or 88CS

1. Attach chin strap to inner shell by sliding chin strap keyway slot over plastic head on button inside the inner shell. Refer to 20NC chin strap installation instructions.
2. Put helmet on your head. Adjust chin strap length with the plastic slide.

### Optional Lens Covers

1. If desired, apply optional lens covers designed to protect the respirator's plastic lens. Apply 2-3 lens covers at a time.
2. When lens becomes soiled, remove by pulling tab at edge of lens cover to clear your vision.

## Attaching Cape to Helmet

1. Place cape on table or workbench. (Figure 4, page 12)
2. With window frame open, place helmet on top of cape.
3. Line up the clampon the cape with the front center of the helmet (Figure 4, page 12).

### NOTE

Installation is easiest when started at the front of cape and helmet.

4. Ease caperim completely into the groove along helmet edge, working your way to the back. Be certain cape is completely in place at every point along helmet's bottom edge.
5. Snap the clampto tightencable and hold capes snugly on helmet, while ensuring the cape stays in the groove.
6. Close and latch window frame.

## Installing Breathing Tube Assembly onto Respirator Helmet

1. Connect breathing tube assembly to helmet by screwing plastic hose connector to fitting located on the side of the helmet. Turn clockwise to tighten (Figure 9).

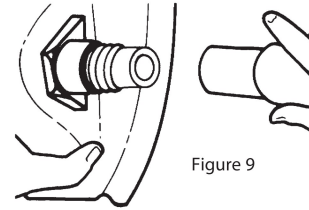

Figure 9

### NOTE

Do not remove foam from inside the breathing tube. The foam helps reduce the noise level of the incoming air.

## Using Climate Control Devices

88VX Series respirators are approved by NIOSH for use with four (4) optional Bullard climate control devices: AC1000 Series, DC50 Series, HC2400 Series and Frigitron 2000 Series.

1. Follow the instructions supplied with your climate control device.
2. Be sure to use only the 88VXBT with your climate control device.
3. Screw hose connector on end of breathing tube to hose thread on climate control device.
4. Firmly tighten hose connector by hand (Figure 10).
5. Lace belts supplied with respirator through belt loop bracket on climate control device.

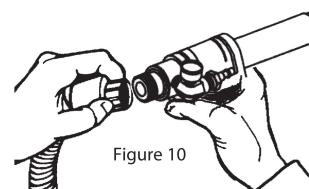

Figure 10

### WARNING

Only use climate control devices manufactured by Bullard. Substituting other climate control devices will void the NIOSH approval and could result in death or serious injury.

## 88VX Respirator Use

### ⚠ WARNING

Do not put on or remove this respirator in a hazardous atmosphere. Do not remove this respirator in a hazardous atmosphere except for emergency escape purposes. Failure to follow these instructions could result in death or serious injury.

### Donning

Before using your 88VX Series respirator, complete the assembly instructions given on pages 12-13. Before putting on respirator, make sure there is no dirt, dust, or contaminants inside the helmet.

1. Connect the Bullard air supply hose that is part of the NIOSH approved system to the air source supplying Grade D breathing air. Turn on the breathing air source.
2. With air flowing, connect breathing tube assembly to air supply hose. Connect quick-disconnect fitting on breathing tube assembly to quick-disconnect coupler on air supply hose. Once fitting is secured, release couplings sleeve to lock fittings together. Pull on both hoses to make sure they are attached securely.
3. Adjust air pressure at point-of-attachment (Figure 2, Page 8) to within the approved pressure range on the Breathing Air Pressure Table (Page 10) for approved pressure ranges.
4. With air still flowing, lower 88VX Series respirator helmet onto your head for a comfortable fit.
5. Position headband for a comfortable fit. See instructions on pages 12 and 13 for proper headband sizing.
6. Pull elastic chin strap under your chin and adjust for a secure and comfortable fit. The chin strap will help balance the helmet and should be worn at all times.
7. Be sure that the knitted inner neck cuff fits snugly around your neck to help provide a barrier to airborne contaminants.
8. With breathing tube assembly attached to the helmet, fasten belt around waist or hips and adjust for comfort.
9. Pull respirator cape around your body and secure sides by connecting the snap hooks. If using the Golden Gate cape, first secure the ties that connect in back, then in front. If using the Hibernia parka, tighten belt at waist.
10. Recheck air pressure and adjust if necessary.
11. With air still flowing into your respirator, you are now ready to enter work area.

ⓘ NOTE  
OSHA respirator regulations do not require fitting of loose fitting air hoods and helmets.

### Doffing

When finished working, leave work area wearing respirator and with air still flowing. Once outside contaminated area, remove respirator and then disconnect the air supply hose using the quick-disconnect fittings.

### ⓘ NOTE

If using V20 Series (1/2" I.D.) air supply hose, the quick-disconnect coupler does not have a shut-off valve. Therefore, air will continue to flow freely after disconnecting hose from respirator.

### ⚠ WARNING

Leave work immediately if:

- Any respirator component becomes damaged.
- Airflow into respirator helmet stops or slows down.
- Air pressure gauge drops below the minimum specified in the Breathing Air Pressure Table (page 10).
- Breathing becomes difficult.
- You become dizzy, nauseous, too hot, too cold or ill.
- You taste, smell or see contaminants inside respirator helmet.
- Vision becomes impaired.

Failure to follow these instructions could result in death or serious injury.

### ⚠ WARNING

Do not leave respirator in work area. Respirable dust contaminants can remain suspended in the air for more than one hour after work activity ceases, even though you may not see them. Proper work practice requires you to wear the respirator until you are outside the contaminated area. Failure to don, doff and store the respirator outside of contaminated area could result in exposure to contaminants. Failure to follow these instructions could result in death or serious injury.



Adjust neck cuff

Always wear respirator in work area

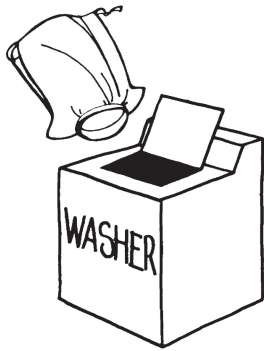

Your respirator cape may be machine washed

## Inspection, Cleaning and Storage

Bullard's 88VX Series respirators have a limited service life. Therefore, a regular inspection and replacement program must be conducted. Certain parts such as capes and lenses must be replaced frequently.

The 88VX Series respirator and all component parts and assemblies should be inspected for damage or excessive wear, before and after each use, to ensure proper functioning. Immediately remove the respirator from service and replace parts or assemblies that show any sign of failure or excessive wear that might reduce the degree of protection originally provided.

Use only complete Bullard 88VX Series components and replacement parts on this respirator. Refer to parts list (Pages 16-19) for correct part numbers.

Since respirator use and the quality of maintenance performed vary with each job site, it is impossible to provide a specific time frame for respirator replacement. As a general guideline, the 88VX Series respirator should be replaced after two years of service or less.

This respirator should be cleaned and sanitized at least weekly, or more often if subjected to heavy use. Respirators used by more than one person must be cleaned, inspected and sanitized after each use. If not cleaned, contamination may cause illness or disease.

**REMEMBER, THE AIR YOU BREATHE WILL NOT BE CLEAN UNLESS THE RESPIRATOR YOU WEAR IS CLEAN.**

### Cape

#### Inspection

Remove the cape from the respirator helmet and inspect it for rips, tears or damage from excessive wear that might reduce the degree of protection originally provided. Inspect the inner neck cuff for elasticity.

If you detect any of these signs, replace your cape immediately or remove the respirator from service.

#### **⚠ WARNING**

Do not substitute any capes other than those manufactured by Bullard. Substituting other capes will void the NIOSH approval and could result in death or serious injury.

#### Cleaning

Machine wash the cape in cold or warm water using a gentle cycle. Use a mild laundry detergent. Air-dry only. After cleaning, carefully inspect the cape once again for signs of damage.

Do not use volatile solvents to clean this respirator or any parts and assemblies. Strong cleaning and disinfecting agents, and many solvents, can damage the plastic parts.

## Headband and Chin Strap

#### Inspection

Remove the headband suspension and chin strap from the inner shell. Inspect the headband for cracks, frayed or cut crown straps, torn headband or size adjustment slots, loss of pliability or other signs of excessive wear. Check the chin strap for loss of elasticity, cuts and cracked hanger clips.

If damage is detected, replace parts immediately with Bullard replacement parts or remove the respirator from service.

#### Cleaning

The headband suspension and chin strap should be hand-sponged with warm water and mild detergent, rinsed and air-dried. After cleaning and before reassembling, once again carefully inspect the parts for signs of damage.

## Helmet

#### Inspection

Inspect the helmet and inner shell for nicks, gouges, cracks, holes and any damage due to impact, rough treatment or wear.

If damage is detected, replace parts immediately with Bullard replacement parts or remove the respirator from service.

#### Cleaning

The helmet, inner shell, and window frame should be hand-sponged with warm water and mild detergent, rinsed and air-dried.

After cleaning and before reassembling, once again carefully inspect the helmet and parts for signs of damage.

## Lenses and Window Frame Gasket

#### Inspection

Besure the plastic inner lens fits securely in the window frame gasket. Remove any grit or dust from the gasket. Besure the plastic outer lens is installed underneath the clamps on the back of the outer window frame. Inspect the window frame gasket closely for cuts, wear or damage that will prevent a proper seal against the inner face shield lens or the helmet window frame.

If damage is detected, replace parts immediately with Bullard replacement parts or remove the respirator from service.

#### Cleaning

To clean the lenses, hand-sponge with warm water and mild detergent, rinse and air-dry.

#### **⚠ WARNING**

Do not use lenses other than those listed on the next page. Substituting other lenses voids the NIOSH approval. Use of non-Bullard lenses may allow contaminants to enter the respirator and could result in death or serious injury.

**NOTE**  
All Bullard lenses are stamped with the appropriate Bullard part number described below.

Bullard Lens Description	Part No.
Inner lens for 88VX Series Respirators (oval)	P771B
Outer lenses for 88VX Series Respirators (oval)	B771040
Outer lenses for 88VX Series Respirators (rectangular)	B771R

## Breathing Tube Assembly

### Inspection

Inspect the breathing tube for tears, cracks, holes, or excessive wear that might reduce the degree of protection originally provided. If any signs of excessive wear are present, replace the breathing tube immediately or remove the respirator from service.

### Cleaning

To clean the breathing tube, hand-sponge with warm water and mild detergent, being careful not to get water inside. Rinse and air-dry. After cleaning, once again carefully inspect breathing tube for signs of damage.

### CAUTION

Do not cut or remove foam that is inside the breathing tube. The foam helps reduce the noise level of the incoming air supply. It does not filter or purify your breathing air. NIOSH has approved this respirator with the foam in place. Failure to observe these instructions may result in minor or moderate injury.

## Air Supply Hose

### Inspection

The starter and extension hose(s) should be inspected closely for abrasions, corrosion, cuts, cracks and blistering. Be sure the hose fittings are crimped tightly to the hose so that air cannot escape. Make sure the hose has not been kinked or crushed by any equipment that may have rolled over it.

If any of the above signs are present or any other signs of excessive wear are detected, replace the air supply hose(s) immediately or remove the respirator from service.

### Cleaning

The air supply hose(s) should be hand-sponged with warm water and mild detergent, rinsed and air-dried. Do not get water inside the air supply hose. After cleaning, once again carefully inspect air supply hose(s) for signs of damage.

### WARNING

Only use hoses that are approved for use with this respirator. Other hoses could reduce airflow and protection, and expose the wearer to life-threatening conditions. Failure to follow these instructions could result in death or serious injury.

## Storage

After reusable respirator components have been cleaned, dried and inspected, place them in a plastic bag or an airtight container.

Store the respirator and parts where they will be protected from contamination, distortion and damage from elements such as dust, direct sunlight, heat, extreme cold, excessive moisture and harmful chemicals.



Store in a clean place away from contaminants

# 88VX Series Airline Respirator User Manual

## Parts and Accessories for 88VX Series Airline Respirators

88VX Series supplied-air respirators consist of four components: 1.) respirator helmet assembly with breathing tube, 2.) cape, 3.) flow control device, and 4.) air supply hose. There are options for some components to fit customer specifications. All components must be present and properly assembled, including a Bullard air supply hose, to constitute a complete NIOSH approved respirator (Approval No. TC-19C-0293, Type C and CE).

CATALOG NUMBER	DESCRIPTION	CATALOG NUMBER	DESCRIPTION
<b>Parts for 88VX Series Respirators</b>		DC5040	DUAL-COOL tube - 1/4" Industrial Interchange (steel) quick disconnect fitting. Order DUAL-COOL vest separately
88VXTGP	4-point headband suspension with sizing posts and poly brow pad	<b>Dual-Cool Vest</b>	
88VXRTP	4-point headband suspension with Flex-Gear ratchet sizing knob and poly brow pad	DC70ML	DUAL-COOL vest. Size: M/L. Order DUAL-COOL tube separately.
20NC	Elastic Chin Strap	DC70LXXL	DUAL-COOL vest. Size: XL/XXL. Order DUAL-COOL tube separately.
88CK	Breathing tube connector kit	DC705X	DUAL-COOL vest. Size 5X. Order DUAL-COOL tube separately.
88VXAK	Oval door/Gasket/Latch Kit Assembly	CH60	Connector hose for use with DUAL-COOL
BFW	Box Front Adapter Kit, complete (for 88 and 88VX Series only)	<b>Replacement Parts for Breathing Tube Assemblies</b>	
77GLT	Tempered Glass Lens for BFW	88VXBT	Breathing tube only, with threaded hose connectors
77LG	Box Front Lens Gasket	4612	Belt, nylon webbing
G7713	88VXR Window Frame Gasket (oval)	F30	Constant flow control valve 1/4" Industrial Interchange (steel)
88CS	Elastic Chin strap	F35	Constant flow control valve, 1/2" Industrial Interchange (steel)
88VXCP	Cheek pads	F40	Adjustable flow control valve, 1/4" Industrial Interchange (steel)
<b>Lenses and Mylar Covers</b>		<b>Air Supply Hose Kits</b>	
<b>Lenses for 88VX Series (oval)</b>		V10 Series Hoses (3/8" I.D.) for use with breathing air compressors	
P771B	Inner Tritan Lens, .040" thick (25/pkg)	4696	25-foot Starter hose with 1/4" Industrial Interchange Q.D. coupler and male nipple
B771B	Inner Tritan Lens, .040" thick (200/bx)	46913	25-foot Starter hose with 1/4" Schrader Q.D. coupler
<b>Lenses for 88VX Series</b>		46915	25-foot Starter hose with 1/4" Snap-Tite Q.D. coupler
7714	Clear Rectangular Mylar Lens Cover, Adhesive Backed (25/pkg)	5454	25-foot Extension hose
88VXLC	Clear Oval Mylar Lens Cover, Perforated-Edges with pull tab (25/pkg)	5457	50-foot Extension hose
88VXOLG	Outer Lens, Tinted Green, .042" thick (25/pkg)	5458	100-foot Extension hose
88VXOLT	Outer Lens, Tinted Smoke, .030" thick (25/pkg)	<b>V20 Series Hoses (1/2" I.D.) for use with breathing air compressors, and Free-Air Pumps</b>	
<b>Capes</b>		V2050ST	50-foot Starter/Extension hose with 1/2" Industrial Interchange Q.D. coupler
46VX	Tan Nylon Cape - 28" length	V20100ST	100-foot Starter/Extension hose with 1/2" Industrial Interchange Q.D. coupler
13VX	Tan Nylon Cape - 38" length		
21821	Tan Nylon Cape, Golden Gate Style - 38" length		
36VX	Hibernia Parka - Tan Nylon Parka with sleeves - 38" length		
36XLVX	Hibernia Parka - Tan Nylon Parka with sleeves - 38" length, extra-large		
<b>Flow Control Devices (Includes Belt)</b>			
<b>Adjustable Flow</b>			
AC100030	Air Conditioner - 1/4" Industrial Interchange (steel) quick-disconnect fitting		
Frigitron 2000	Air Conditioner - 1/2" Industrial Interchange (steel) quick-disconnect fitting, (for use with Bullard EDP30 Free-Air pump)		
HC240030	Hot/Cold tube - 1/4" Industrial Interchange (steel) quick-disconnect fitting		

CATALOG NUMBER DESCRIPTION

**Quick-Disconnect Nipples**

- 1/4" Industrial Interchange
- V17 With 3/8" Female NPT
- 1/4" Schrader
- S19432 With 1/4" Female NPT
- 1/4" Snap-Tite
- S19442 With 1/4" Female NPT

**Quick-Disconnect Couplers (Shut-off Type)**

- 1/4" Industrial Interchange
- V14 With 1/4" Female NPT
- 1/4" Schrader
- V18 With 1/4" Female NPT
- 1/4" Snap-Tite
- V19 With 1/4" Female NPT

CATALOG NUMBER DESCRIPTION

**Quick-Disconnect Hose Adapters**

- V11 Hose-to-hose, 3/8" hose to 3/8" hose
- V12 Hose-to-pipe, 3/8" hose to 1/4" pipe
- V13 Hose-to-pipe, 3/8" hose to 3/8" pipe

To order replacement parts, contact your local Bullard distributor or the Bullard Customer Service Department.

Bullard  
1898 Safety Way  
Cynthiana, KY 41031-9303  
Toll Free: 877-BULLARD (285-5273)  
Phone: 859-234-6616  
Facsimile: 859-234-8987

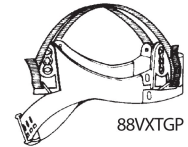
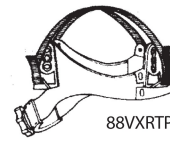
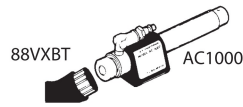
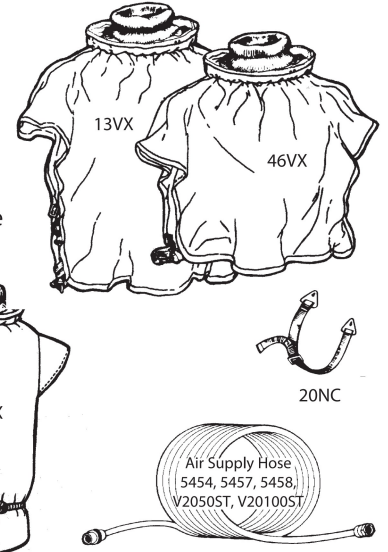

**Other Available Flow Control Assemblies (Without Breathing Tube)**

CATALOG NUMBER DESCRIPTION

**Adjustable Flow**

- F40B 1/4" Industrial Interchange (brass)
- F40S 1/4" Industrial Interchange (stainless steel)
- F41 1/4" Schrader
- F42 1/4" Snap-Tite (steel)
- F43 1/4" Snap-Tite (brass)
- F44 1/4" Snap-Tite (stainless steel)
- F47 1/4" Cejn
- F48 1/4" Bayonet

**Constant Flow**

- F30B 1/4" Industrial Interchange (brass)
- F30S 1/4" Industrial Interchange (stainless steel)
- F31 1/4" Schrader
- F32 1/4" Snap-Tite (steel)
- F33 1/4" Snap-Tite (brass)
- F34 1/4" Snap-Tite (stainless steel)
- F37 1/4" Cejn
- F38 1/4" Bayonet
- F35B 1/2" Industrial Interchange (brass)
- F35S 1/2" Industrial Interchange (stainless steel)

**Adjustable Climate Control Tubes**

Cold Only	Hot/Cold	Dual-Cool	Coupling Type
AC100030(S)(B)		HC240030(S)(B)	DC5040(S)(B) 1/4" Industrial Interchange
AC100031	HC240031	DC5041	1/4" Schrader
AC100032	HC240032	DC5042	1/4" Snap-Tite (steel)
AC100033	HC240033	DC5043	1/4" Snap-Tite (brass)
AC100034	HC240034	DC5044	1/4" Snap-Tite (stainless steel)
AC100037	HC240037	DC5047	1/4" CEJN
AC100038	HC240038	DC5048	1/4" Bayonet

# 88VX Series Airline Respirator User Manual

## 88VX Series Respirator Replacement Parts

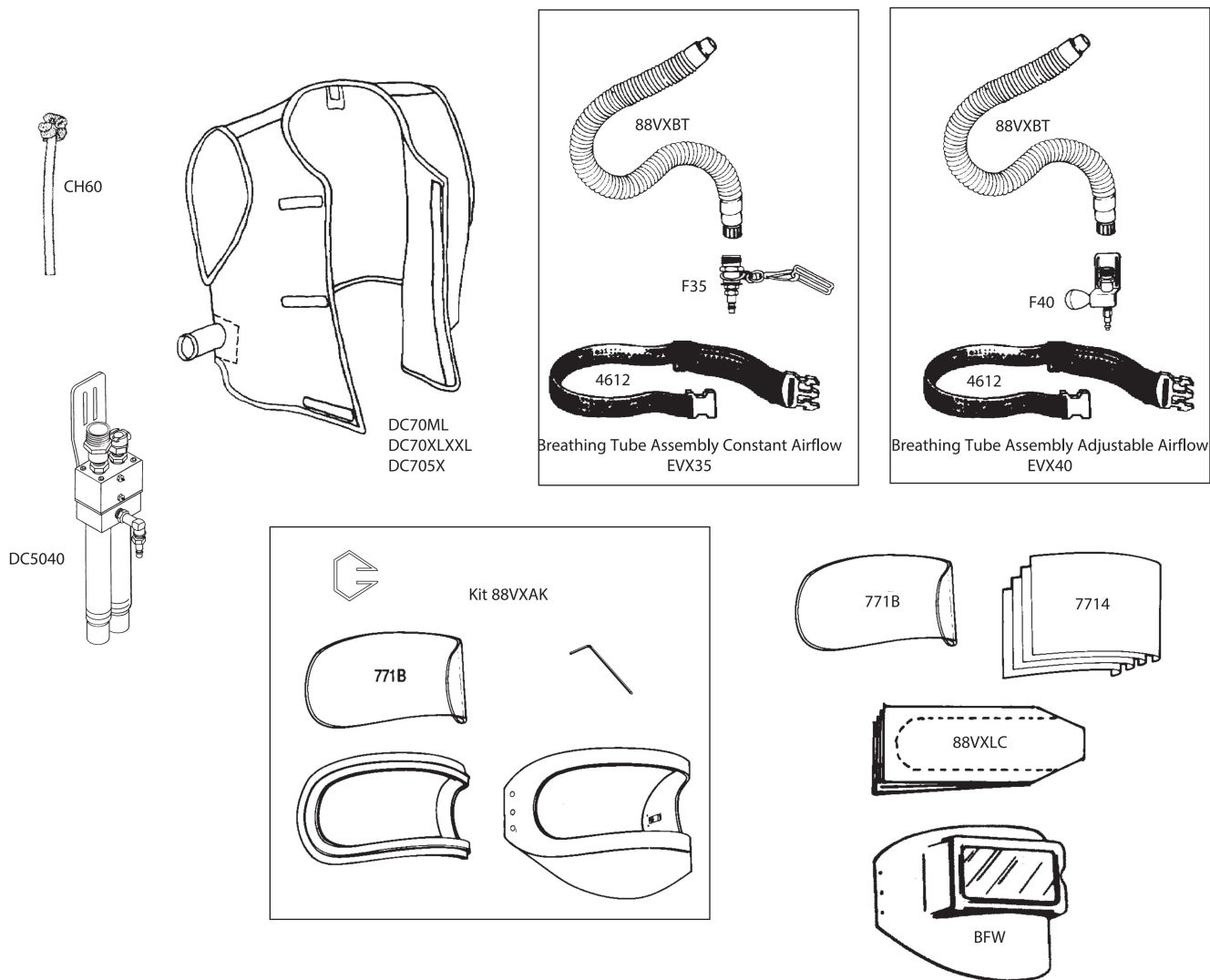

## For optional use with Bullard Airline Respirators

Includes: AC1000 Cool Tube, belt bracket, nylon belt and heat shield.

Function: The AC1000 is designed to supply a continuous flow of cool air to certain Bullard supplied air respirators.

### WARNING

This climate control system is not recommended for cooling the air supply when the air temperature is less than 70°F (21°C). Since the system may cool the incoming air by more than 30°F (17°C), it is possible for ice to form in the breathing tube and reduce the airflow. Failure to observe this warning could result in death or serious injury.

## Air Pressure

Continually monitor the air pressure at the point-of-attachment while operating the respirator. A reliable air pressure gauge must be present to monitor the pressure.

### WARNING

Failure to supply the minimum required pressure at the point-of-attachment for your hose length will reduce airflow and could result in death or serious injury.

It is important to operate the Bullard climate control device in the prescribed pressure range for the particular Bullard respirator you are using. Refer to the user manuals' Breathing Air Pressure Table to determine the correct pressure that should be used with the climate control device.

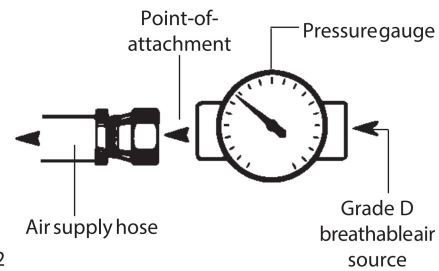
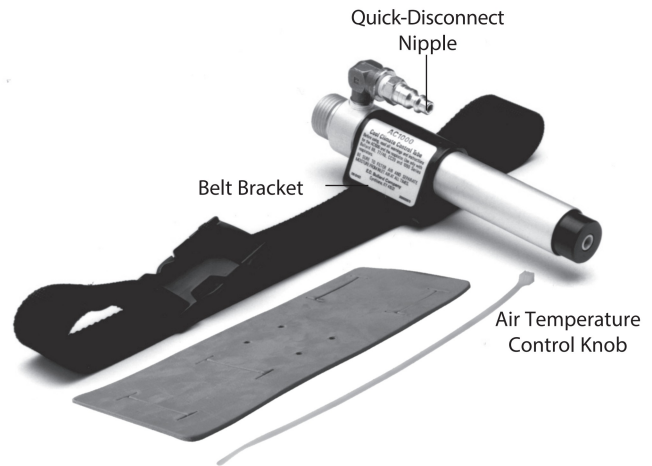

Figure 2

## Preparation and Use of the AC1000

1. In an uncontaminated atmosphere screw the hose connector fitting on the end of the breathing tube to the fitting on the AC1000. Tighten hose connectors firmly (Figure 1).
2. Lace the belt supplied with the Cool Tube through the belt bracket. Slots are provided for wearing the tube either vertically or horizontally on the waist. See Heat Shield instructions.
3. With the approved Bullard air supply hose connected to the air source and with air flowing into the hose, connect the quick-disconnect coupler on the air supply hose to the quick-disconnect nipple on the AC1000 Cool Tube.

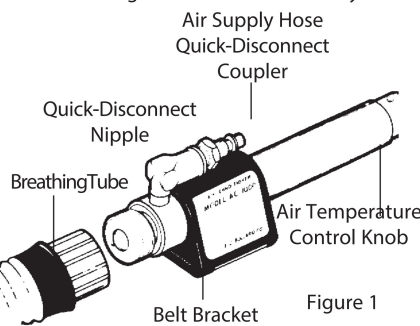

Figure 1

4. Adjust the air pressure at the point-of-attachment to within the approved pressure range (Figure 2). Refer to the user manuals' Breathing Air Pressure Table to determine the correct pressure that should be used with the climate control device.
5. Don the respirator by following the directions in your respirator instruction manual.
6. To obtain cooler air, turn the air temperature control knob counter-clockwise (Figure 1). Maximum cooling is attained when knob is fully open and when there is maximum airflow out of the AC1000 exhaust port.  
To obtain air that is closer to ambient temperature, turn air temperature control knob clockwise. If knob is fully closed, your respirator will receive air at ambient temperature.
7. When finished working, leave the work area wearing the respirator. With the air still flowing into the hood, remove the hood and then disconnect the air supply hose using the quick-disconnect coupler attached to the AC1000 Cool Tube.

## Heat Shield Instructions

### Assembly

1. Determine whether the climate control device will be worn vertically or horizontally on the waist.
2. If the device will be worn in the horizontal position, align the tube on the heat shield as shown in Figure 3. If the tube will be worn in the vertical position, align the tube on the heat shield as shown in Figure 4.
3. Lace the belts supplied with your climate control device through both the heat shield slots and the climate control belt bracket slots.
4. Use plastic zip tie to secure the climate control unit to the heat shield.

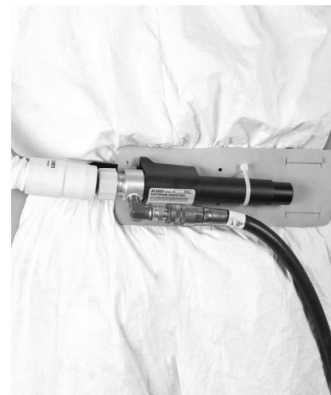

Figure 3



Figure 4

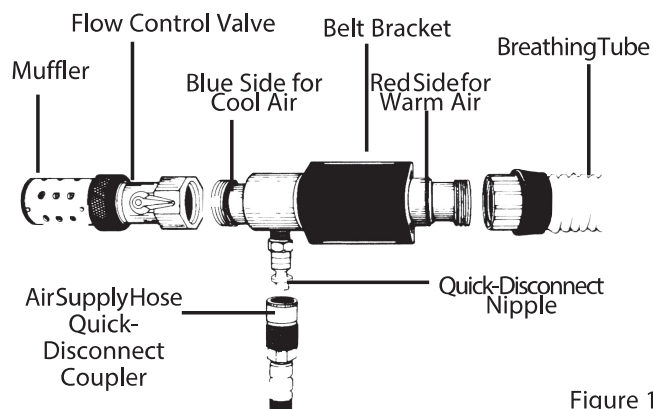

Figure 1

## For optional use with Bullard Airline Respirators

Includes: Hot/Cold Tube, Flow Control Valve, Belt Bracket, Belt and Heat Shield

### Function

The HC2400 is designed to supply a continuous flow of warm or cool air to certain Bullard Supplied-Air Respirators.

### NOTE

HC2400 cannot be used with a low pressure air source such as an ambient air pump.

### WARNING

This climate control system is not recommended for cooling the air supply when the air temperature is less than 70°F (21°C). Since the system may cool the incoming air by more than 30°F (17°C), it is possible for ice to form in the breathing tube and reduce the airflow. Failure to follow these instructions could result in death or serious injury.

### Air Pressure

Continually monitor the air pressure at the point-of-attachment while operating the respirator. A reliable air pressure gauge must be present to monitor the pressure.

### WARNING

Failure to supply the minimum required pressure at the point-of-attachment for your hose length will reduce airflow and could result in death or serious injury.

It is important to operate the Bullard climate control device in the prescribed pressure range for the particular Bullard respirator you are using. Operating the correct pressure range will insure that the correct air flow is delivered to the respirator and will maintain the NIOSH approval. Refer to the user manuals' Breathing Air Pressure Table to determine the correct pressure that should be used with the climate control device.

## Preparation and Use of the HC2400

### 1. For Warm Air:

- (a) In an uncontaminated atmosphere, screw the hose connector on the end of the breathing tube onto the RED side of the HC2400 Tube.
- (b) Screw the flow control valve and muffler onto the blue side of the HC2400 Tube (Figure 1). Tighten both connections firmly.

### For Cool Air:

- (a) In an uncontaminated atmosphere, screw the hose connector on the end of the breathing tube on to the BLUE side of the HC2400 Tube.
- (b) Screw the flow control valve and muffler to the RED side. Tighten firmly.

#### ⚠ WARNING

For adequate airflow, attach the muffler and flow control valve to the end of the hot/cold tube that is opposite the breathing tube end.

Failure to observe this warning could result in death or serious injury.

DO NOT USE THE HC2400 WITHOUT THE MUFFLER AND FLOW CONTROL VALVE.

2. Lace the belts supplied with the HC2400 through the belt bracket. Slots are provided for wearing the tube either vertically or horizontally on the waist. See Heat Shield instructions below.
3. With the approved Bullard air supply hose connected to the air source and with air flowing into the hose, connect the quick-disconnect coupler on the air supply hose to the quick-disconnect nipple on the Hot/Cold Tube.
4. Adjust the air pressure at the point-of-attachment (Figure 2) to within the approved pressure range. See the Respirator Breathing Air Pressure table in the respirator user manual.
5. Put the hood on by following the directions in your respirator instruction manual. If you do not have instructions, contact Bullard Customer Service at the address or phone numbers below.
6. Turn flow control valve to adjust the flow and temperature of incoming air (Figure 1).

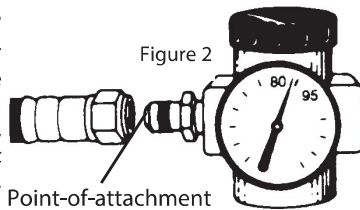

Figure 2

Maximum cooling or warming is attained when knob is fully open and when there is maximum airflow out of the HC2400 exhaust port. To obtain air that is closer to ambient temperature, turn air temperature control knob to the fully closed position. If knob is fully closed, your respirator will receive air at ambient temperature.

7. When finished working, leave the work area wearing the respirator. With the air still flowing into the hood, remove the hood and then disconnect the air supply hose using the quick-disconnect coupler attached to the Hot/Cold Tube.

## Heat Shield Instructions

### Assembly

1. Determine whether the climate control device will be worn vertically or horizontally on the waist.
2. If the device will be worn in the horizontal position, align the tube on the heat shield as shown in Figure 3. If the tube will be worn in the vertical position, align the tube on the heat shield as shown in Figure 4.
3. Lace the belts supplied with your climate control device through both the heat shield slots and the climate control belt bracket slots.

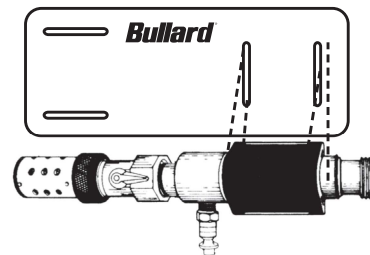

Figure 3

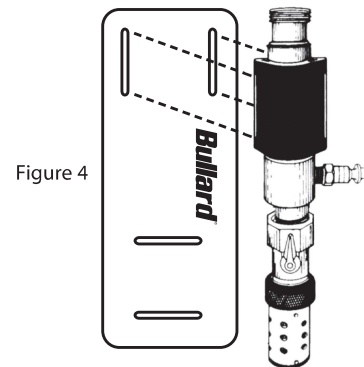

Figure 4

For optional use with Bullard Airline Respirators



The DC50 Dual-Cool tube is designed to supply a continuous flow of cool air to certain Bullard supplied air respirators and body vests. The DC50 Dual-Cool tube cannot be used with a low pressure air source such as an ambient air pump.

### Air Pressure

Breathing air pressure must be continually monitored at the point-of-attachment while operating the respirator. A reliable air pressure gauge must be present to monitor the pressure during respirator operation.

**WARNING**  
 Failure to supply the minimum required pressure at the point-of-attachment for your hose length and type will reduce airflow and could result in death or serious injury.

The Breathing Air Pressure Table in the user manual defines the air pressure ranges necessary to provide the respirator with a volume of air that falls within the required range of 6-15 cubic feet per minute (cfm) or 170-425 liters per minute (lpm). (See 42 CFR, Part 84, Subpart J, 84.150)

**WARNING**  
 The DC50 Dual-Cool climate control system is not recommended for cooling the air supply when the air temperature is less than 70°F (21°C). Because the DC50 Dual-Cool may cool the incoming air by more than 30°F (17°C), it is possible for ice to form in the breathing tube and reduce the airflow. Failure to observe these warnings could result in death or serious injury.

### Assembly and Use

Assembly must be conducted in an uncontaminated atmosphere.

#### Assembling the Cooling Vest

1. Insert the muffler end of the cooling vest connector hose well into the air entry sleeve of the vest (Figure 1).
2. Secure the cooling vest hose using the clamp (Figure 2) around the entry sleeve of the vest.

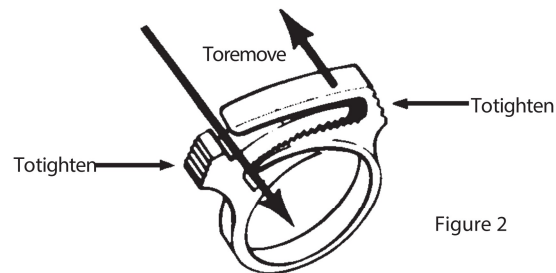
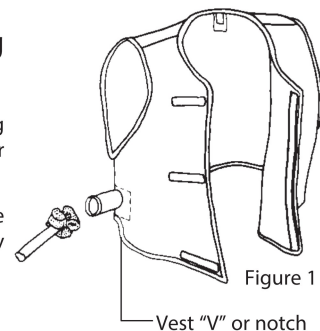

## Head Shield Assembly Instructions

The HSDC climate control heat shield is designed to work with the Bullard DC50 Dual-Cool climate control device.

### Assembly

1. Lace the belts supplied with your climate control device through both the heat shield slots and the climate control belt bracket slots.
2. Use plastic zip ties (2 included) to secure the climate control to the heat shield. (Figure 3)

## Donning the Dual-Cool Tube and Cooling Vest

1. Screw the hose connector that is on the end of the breathing tube to threaded connector on Dual-Cool. Lace the belt through the slots in the belt bracket (Figure 3).

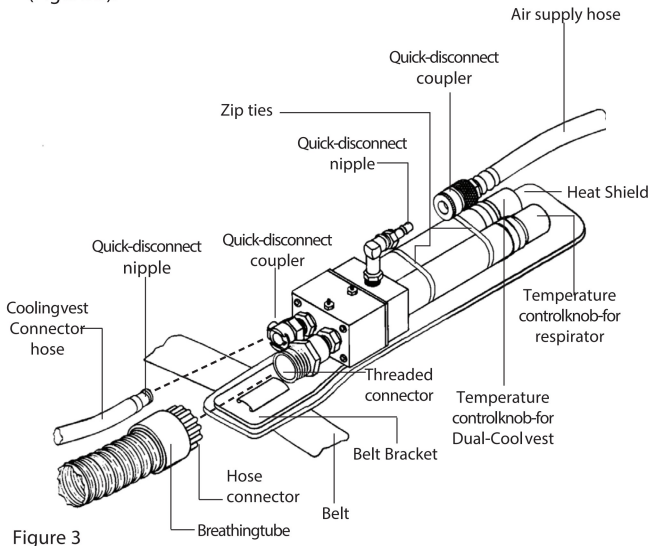

Figure 3

2. Don the belt, belt bracket, and Dual-Cool. Adjust belt comfortably, but loosely, around your waist, insuring that the Dual-Cool assembly is on your right-hand side.
3. Don the vest. Use the Velcro® closure strips to adjust loosely for size.

### NOTE

The vest should mount over the belt with the Dual-Cool unit positioned in the "V" of the vest found on the right-hand side (Figure 1).

4. Snap the quick-disconnect nipple found on the end of the cooling vest connector hose into the quick-disconnect coupler on the Dual-Cool (Figure 3).
5. Don the respirator by following the directions in your respirator instruction manual. If you do not have instructions, contact Bullard Customer Service at the address or phone number given below.
6. With the approved Bullard air supply hose connected to the breathing air source, and with air flowing into the hose, connect the quick-disconnect coupler on the air supply hose to the quick-disconnect nipple on the Dual-Cool (Figure 3).
7. Adjust the air pressure at the point-of-attachment to within the approved pressure range found in the respirator user manual (Figure 4).

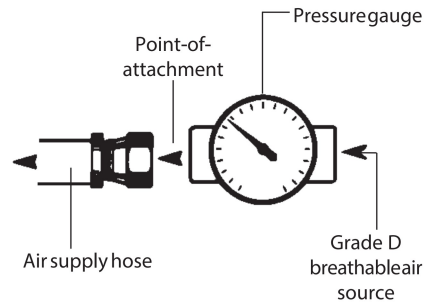

Figure 4

## Operating the Dual-Cool Tube

1. To obtain cooler air, turn the air temperature control knobs counterclockwise (Figure 3). Maximum cooling is obtained when knobs are open completely and when there is maximum airflow out of the Dual-Cool tube's exhaust ports. To obtain air that is closer to ambient temperature, turn air temperature control knobs clockwise. If knobs are closed completely, your respirator will receive air that is essentially at ambient temperature.

### NOTE

There are separate controls to adjust the temperature of the air that is distributed to the vest and the breathing zone. The one knob controls the air temperature to the respirator; the other knob controls the air temperature to the cooling vest (Figure 3).

2. When finished working, leave the work area wearing the respirator. With the air still flowing, remove the hood, and then disconnect the air supply hose using the quick-disconnect coupler attached to the Dual-Cool.

## Cleaning

Machine wash the vest in warm water using a gentle cycle. Use a mild laundry detergent. Air-dry only. After cleaning, carefully inspect the vest for any signs of damage. If any damage is detected, remove the vest from service.

For optional use with Bullard Airline Respirators

INCLUDES: Frigitron 2000 and Belt

FUNCTION: The Frigitron 2000 is designed to supply a continuous flow of cool air as part of certain Bullard supplied air respirator systems.

**NOTE:**  
Frigitron 2000 CAN be used with a low pressure air source, such as Bullard ambient air pump Models ADP20, and ICEPUMP11.

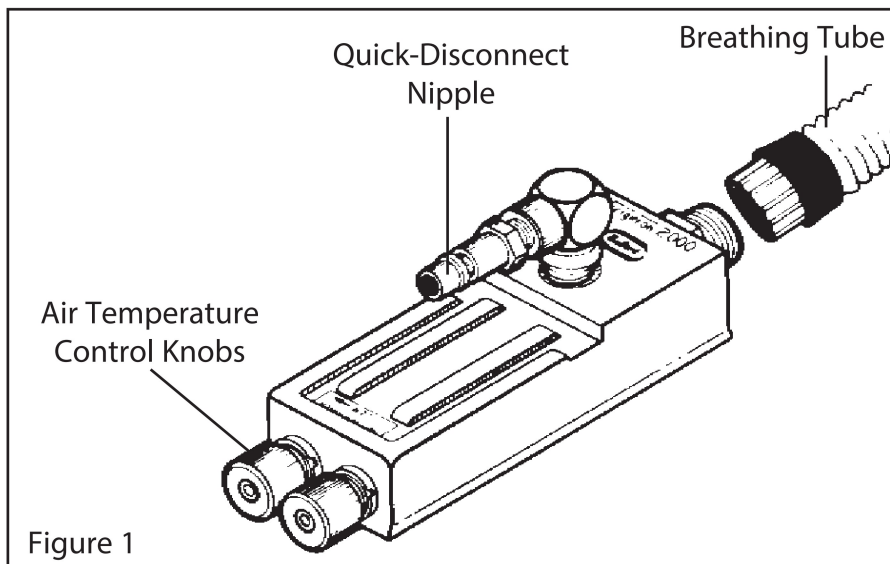

Figure 1

## Air Pressure

Continually monitor the air pressure at the point-of-attachment while operating the respirator. A reliable air pressure gauge must be present to monitor the pressure.

<b>▲ WARNING</b>
Failure to supply the minimum required pressure at the point-of-attachment for your hose length will reduce air flow and may expose you to life threatening conditions, diseases or death.

The BREATHING AIR PRESSURE TABLE in the user manual defines the air pressure ranges necessary to provide the respirator with a volume of air that falls within the required range of 6-15 cubic feet per minute (cfm) or 170-425 liters per minute (lpm).

## Preparation and Use of the Frigitron 2000

1. In an uncontaminated atmosphere, screw the end of the breathing tube to the fitting on the climate control device. Tighten hose connectors firmly.
2. Lace the belt supplied with the Cool Tube through the belt bracket.
3. With the approved Bullard V20 air supply hose connected to the air source and with air flowing into the hose, connect the quick-disconnect coupler on the air supply hose to the quick-disconnect nipple on the Frigitron 2000.
4. Adjust the air pressure at the point-of-attachment to within the approved pressure range (Figure 2).
5. Put the hood on by following the directions in your respirator instruction manual. If you do not have instructions, contact Bullard Customer Service at the address or phone numbers given below.
6. To obtain cooler air, turn either or both of the air temperature control knobs counter clockwise (Figure 1).

Maximum cooling is attained when either or both knobs are fully open and when there is maximum airflow out of the Frigitron exhaust ports.

To obtain air that is closer to ambient temperature, turn either or both air temperature control knob clockwise. If both knobs are fully closed, your respirator will receive air at ambient temperature.

7. When finished working, leave the work area wearing the respirator. With the air still flowing into the hood, remove the hood and then disconnect the air supply hose using the quick-disconnect coupler attached to the Frigitron 2000.

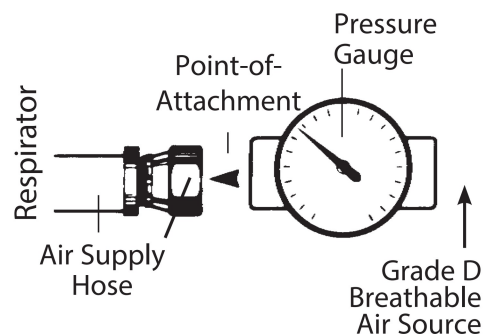

Figure 2

## V10 Starter Hose Instructions

Starter hoses include female quick-disconnect coupler crimped on one end and V13 hose-to-pipe (3/8" NPT) adapter.

1. If the air source has a threaded attachment, use the supplied V13 hose-to-pipe (3/8" NPT) adapter to connect the threaded female fitting on the hose to the air source.
2. If the air source has a coupling attachment, refer to matching QD nipple specification and use either a V12 (1/4") or V13 (3/8") to connect the nipple to the hose (nipple and adapter may be included with certain part numbers). Attach QD nipple to QD coupling on the air source.
3. Connect the respirator's breathing tube fitting to the female quick-disconnect coupler on the V10 hose.

### ⚠ NOTE:

Threaded seal tapes should be used on all threaded attachments. Beveled end of adapters are for hose side of connections.

## V10 Extension Hose Instructions

Extension hoses allow you to add Bullard breathing air supply hose to your Bullard respirator's starter hose or another length of extension hose. For more information on maximum permissible hose lengths, configurations and necessary air pressure operating ranges, please refer to the User Manual Breathing Air Pressure Table. Extension hoses include V11 hose-to-hose adapter and V13 hose-to-pipe (3/8" NPT) adapter.

1. Remove any quick-disconnect nipple or adapter from the air source end of the starter hose and replace it with the V11 hose-to-hose adapter.
2. Connect one end of extension hose to the open end of the V11 adapter just inserted in the starter hose.
3. If the air source has a threaded attachment, use the supplied V13 hose-to-pipe (3/8" NPT) adapter to connect the threaded female fitting on the hose to the air source.

4. If the air source has a coupling attachment, refer to matching QD nipple specification and use either a V12 (1/4") or V13 (3/8") to connect the nipple to the hose. Attach QD nipple to QD coupling on the air source.

### ⚠ NOTE:

Threaded seal tapes should be used on all threaded attachments. Beveled end of adapters are for hose side of connections.

## Respirable Breathing Air

Respirable breathing air must be supplied to the point-of-attachment of the approved breathing air supply hose. Government regulations require that all breathing air meet the specifications for Grade D breathing air as described in Compressed Gas Association Commodity Specification G-7.1-1989 and specified by federal Law 30 CFR, Part II, Subpart J, 11.121(b).

### ⚠ WARNING

DO NOT connect your Bullard breathing air supply hose to nitrogen, toxic gases, inert gases, or other non-breathable, non-grade D air sources. Breathing air hose connection fittings must be incompatible with fittings for other industrial gases as described by the Compressed Gas Association.

## Point-of-attachment

Air pressure at the point-of-attachment must be regulated with the ranges specified in your user manuals' Breathing Air Pressure Table.

### ⚠ NOTE:

You can repeat the extension hose connection steps using Bullard V10 hoses. However, do not exceed the lengths specified in the instruction manual for your specific respirator.

# V10 (3/8") & V20 (1/2") Breathing Air Supply Hose Installation Instructions

# 88VX Series Airline Respirator User Manual

## V10 Breathing Air Supply Hose and V10 Extension Hose Kit Assembly

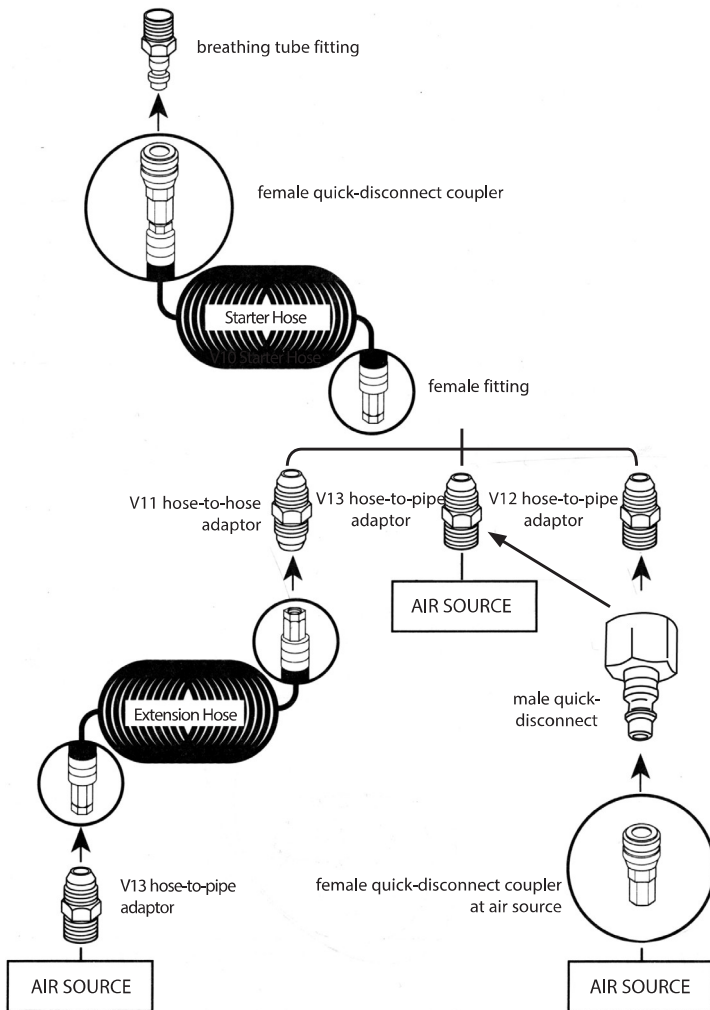

## Bullard V20 Hose Kits

include one V20 rubber starter hose with female quick-disconnect coupler on one end and quick-disconnect nipple on the other.

## Installation Instructions

1. Connect the respirator's breathing tube fitting to the female quick-disconnect coupler on the V20 hose.
2. Connect the quick-disconnect nipple on the hose to the point-of-attachment on your breathing air source.

## Respirable Breathing Air

Respirable breathing air must be supplied to the point-of-attachment of the approved breathing air supply hose. Government regulations require that all breathing air meet the specifications for Grade D breathing air as described in Compressed Gas Association Commodity Specification G-7.1-1989 and specified by Federal Law 30 CFR, Part II Subpart J, 11.121(b).

## Point-of-Attachment

Air pressure at the point-of-attachment must be regulated within the ranges specified in your user manuals' Breathing Air Pressure Table.

## V20 Breathing Air Supply Hose Assembly

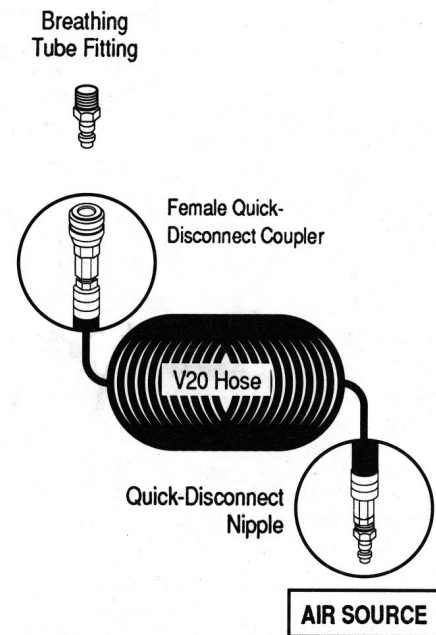

## ⚠ WARNING

Do not connect your Bullard breathing air supply hose to nitrogen, toxic gases, inert gases, or other non-breathable, non-grade D air sources. Breathing air hose connection fittings must be incompatible with fittings for other industrial gases as described by the Compressed Gas Association. Failure to observe this warning may result in death or serious injury.



## One Year Limited Warranty

Bullard warrants to the original purchaser that the 88VX Respirator will be free of defects in material and workmanship under normal use and service for a period of one (1) year from the date of purchase. Bullard's obligation under this warranty is limited to repairing or replacing, at its option, articles that are returned within the warranty period and that are, after examination, shown to Bullard's satisfaction to be defective, subject to the following limitations;

- a) 88VX Respirator must be returned to the Bullard factory with shipping charges prepaid.
- b) 88VX Respirator must not be altered from its original factory configuration.
- c) 88VX Respirator must not have been misused, subjected to negligent use, or damaged in transport.
- d) The date of purchase is within the one year warranty period. (A copy of the purchaser's original invoices showing the date of purchase is required to validate warranty coverage.)

In no event shall Bullard be responsible for damages for loss of use or other indirect, incidental, consequential or special costs, expenses or damages incurred by the purchaser, notwithstanding that Bullard has been advised of the possibility of such damages.

ANY IMPLIED WARRANTIES, INCLUDING WARRANTIES OF MERCHANTABILITY AND FITNESS FOR A PARTICULAR PURPOSE, ARE LIMITED IN DURATION TO ONE (1) YEAR FROM THE DATE OF PURCHASE OF THIS PRODUCT.

Some states do not allow the exclusion or limitation of incidental or consequential damages, or allow limitations on how long an implied warranty lasts, so the above limitations or exclusion may not apply to you. This warranty gives you specific legal rights, and you may have other rights which vary from state to state.

## Return Authorization

The following steps must be completed before Bullard will accept any returned goods. Please read carefully.

Follow the steps outlined below to return goods to Bullard for repair or replacement under warranty or for paid repairs:

1. Contact Bullard Sales Support by telephone or in writing at:

Bullard  
 1898 Safety Way  
 Cynthiana, KY 41031-9303  
 Toll-free: 877-BULLARD (285-5273)  
 Phone: 859-234-6616

In your correspondence or conversation with Sales Support, describe the problem as completely as possible. For your convenience, your sales support specialist will try to help you correct the problem over the phone.

2. Verify with your sales support specialist that the products should be returned to Bullard. Sales Support will provide you with written permission and a return authorization number as well as the labels you will need to return the product.
3. Before returning the product, decontaminate and clean it to remove any hazardous materials which may have settled on the product during use. Laws and/or regulations prohibit the shipment of hazardous or contaminated materials. Products suspected to be contaminated will be professionally discarded at the customer's expense.
4. Ship products to be returned, including those under warranty, with all transportation charges pre-paid. Bullard cannot accept returned goods on a freight collect basis.
5. Returned products will be inspected upon return to the Bullard facility. Bullard Sales Support will telephone you with a quote for required repair work which is not covered by warranty. If the cost of repairs exceeds stated quote by more than 20%, your sales support specialist will call you for authorization to complete repairs. After repairs are completed and the goods have been returned to you, Bullard will invoice you for actual work performed.

<b>California Proposition 65  WARNING</b> Cancer and Reproductive Harm - <a href="http://www.P65Warnings.ca.gov">www.P65Warnings.ca.gov</a>
---



©2021 Bullard. All rights reserved.  
Free-Air and Sure-Lock are registered trademarks of Bullard.

6080885603J (1221)

Bullard Center  
 2421 Fortune Drive  
 Lexington, KY 40509 • USA  
 877-BULLARD (285-5273)  
 Tel: +1-859-234-6616  
 Fax: +1-859-246-0243

Americas Operations  
 1898 Safety Way  
 Cynthiana, KY 41031 • USA  
 877-BULLARD (285-5273)  
 Tel: +1-859-234-6616  
 Fax: +1-859-234-8987

Bullard GmbH  
 Dieselstrasse 8a  
 53424 Remagen • Germany  
 Tel: +49-2642 999980  
 Fax: +49-2642 9999829

Bullard Asia-Pacific Pte. Ltd.  
 LHK Building  
 701, Sims Drive, #04-03  
 Singapore 387383  
 Tel: +65-6745-0556  
 Fax: +65-6745-5176