

# KLUTCH

## MIG/Stick/TIG MP140Si 120 Volt 140 Amp Multi-Process Welder

### Owner's Manual



**⚠ WARNING:** Read carefully and understand all ASSEMBLY AND OPERATION INSTRUCTIONS before operating. Failure to follow the safety rules and other basic safety precautions may result in serious personal injury.

Item #62502

**READ & SAVE THESE INSTRUCTIONS**

Thank you very much for choosing a Klutch® product!

For future reference, please complete the owner's record below:

Serial Number/Lot Date Code: \_\_\_\_\_

Purchase Date: \_\_\_\_\_

Save the receipt, warranty, and this manual. It is important that you read the entire manual to become familiar with this product before you begin using it.

This welder is designed for certain applications only. Northern Tool & Equipment is not responsible for issues arising from modification or improper use of this product such as an application for which it was not designed. We strongly recommend that this product not be modified and/or used for any application other than that for which it was designed.

For technical questions, please call **1-800-222-5381**.

## Table of Contents

Intended Use.....	4
Packaging Contents.....	4
Technical Specifications .....	4
Important Safety Information .....	5
Specific Operation Warnings .....	6
Main Parts of MP140Si.....	11
Setting Up Equipment.....	12
Assembly Instructions.....	18
Before Each Use.....	21
Operating Instructions.....	21
After Each Use.....	34
Maintenance .....	34
Troubleshooting .....	35
Parts Diagram.....	38
Parts List.....	38
Replacement Parts .....	39
Limited Warranty.....	40

## Intended Use

The KLUTCH MIG/Stick/TIG MP140Si is a portable DC inverter wire feed welder capable of welding with solid wire (with shielding gas) or with flux core wire. It comes ready to accept item #44453 Optional Spool Gun for welding aluminum. This machine also has smooth DC stick capabilities and the ability to perform lift start DC TIG welding on steel and stainless steel materials with item #44445, the optional TIG Torch.

Welding with flux core wire gives the operator the flexibility to use this wire feed welder for mobile applications, including outdoor applications. Flux core wire does not require the use of a separate shielding gas which can be blown away by the wind in outdoor applications. Since flux core welding does not use shielding gas, the operator will not have to have shielding gas bottles, or use the regulator and gas hose.

Welding with a MIG wire does require the use a bottle of shielding gas. See the Set-Up guide inside the wire compartment door for recommendations on shielding gas based on the material you are welding. MIG welding is limited to indoor applications, or applications where the influence of wind can be controlled to prevent shielding gas from blowing away. MIG welding allows you to weld thinner materials without burn through. It also creates a much cleaner weld with less spatter and no slag. This results in little post-weld cleaning of the weld joint.

The scratch start TIG function is limited to TIG welding steel and stainless steel. The amperage is controlled by the amperage control on the front of the machine. This machine can be used successfully for repair type TIG welding when needed.

This unit is intended to be used on a 20 amp 120V AC circuit without the use of an extension cord. If an extension cord is necessary for your application, please use the appropriate size and length of extension cord that will handle 20 amps the entire length of the extension. We highly recommend talking with a qualified electrician for cord size recommendations.

## Packaging Contents

- MP140Si
- MIG Torch
- Ground Cable & Clamp
- Regulator/Flow Gauge
- Stick Electrode Holder & Weld Cable
- Gas Hose
- Gas Hose
- Owner's Manual

## Technical Specifications

Property	Specification
Power Supply	120V, 20A, 50/60 Hz, Single Phase
No-Load Voltage	68V DC
Output Range - MIG	30 to 90A DC (140 Peak)
Output Range – STICK/TIG	30 to 70A DC
Duty Cycle	30% @ 90A
Suggested Wire	Steel, Stainless Steel, Aluminum
Suggested Wire Diameter	.023, .030, .035
Suggested Electrodes	E6013, E7014, E7018, Stainless Steel
Electrode Diameter	1/16" to 3/32"
Dimensions	19-3/4" x 8-5/8" x 15"
Weight	28 lb.

## Important Safety Information

### **⚠️WARNING**

- Read and understand all instructions. Failure to follow all instructions may result in serious injury or property damage.
- The warnings, cautions, and instructions in this manual cannot cover all possible conditions or situations that could occur. Exercise common sense and caution when using this tool. Always be aware of the environment and ensure that the tool is used in a safe and responsible manner.
- Do not allow persons to operate or assemble the product until they have read this manual and have developed a thorough understanding of how it works.
- Do not modify this product in any way. Unauthorized modification may impair the function and/or safety and could affect the life of the product. There are specific applications for which the product was designed.
- Use the right tool for the job. DO NOT attempt to force small equipment to do the work of larger industrial equipment. There are certain applications for which this equipment was designed. It will be a safer experience and do the job better at the capacity for which it was intended. DO NOT use this equipment for a purpose for which it was not intended.
- Industrial or commercial applications must follow OSHA requirements.

### **⚠️WARNING**

#### **WORK AREA SAFETY**

- Inspect the work area before each use. Keep work area clean, dry, free of clutter, and well-lit. Cluttered, wet, or dark work areas can result in injury. Using the product in confined work areas may put you dangerously close to cutting tools and rotating parts.
- Do not use the product where there is a risk of causing a fire or an explosion; e.g., in the presence of flammable liquids, gases, or dust. The product can create sparks, which may ignite the flammable liquids, gases, or dust.
- Do not allow the product to come into contact with an electrical source. The tool is not insulated and contact will cause electrical shock.
- Keep children and bystanders away from the work area while operating the tool. Do not allow children to handle the product.
- Be aware of all power lines, electrical circuits, water pipes, and other mechanical hazards in your work area. Some of these hazards may be hidden from your view and may cause personal injury and/or property damage if contacted.

### **⚠️WARNING**

#### **PERSONAL SAFETY**

- Stay alert, watch what you are doing, and use common sense when operating the tool. Do not use the tool while you are tired or under the influence of drugs, alcohol, or medication. A moment of

inattention while operating the tool may result in serious personal injury.

- Dress properly. Do not wear loose clothing, dangling objects, or jewelry. Keep your hair, clothing and gloves away from moving parts. Loose clothes, jewelry, or long hair can be caught in moving parts. Air vents on the tool often cover moving parts and should be avoided.
- Wear the proper personal protective equipment when necessary. Use ANSI Z87.1 compliant safety goggles (not safety glasses) with side shields, or when needed, a face shield. Use a dust mask in dusty work conditions. Also use non-skid safety shoes, hardhat, gloves, dust collection systems, and hearing protection when appropriate. This applies to all persons in the work area.
- Do not overreach. Keep proper footing and balance at all times.

## **⚠CAUTION**

### **WELDER USE AND CARE**

- Do not force the welder. Products are safer and do a better job when used in the manner for which they are designed. Plan your work, and use the correct product for the job.
- Check for damaged parts before each use. Carefully check that the product will operate properly and perform its intended function. Replace damaged or worn parts immediately. Never operate the product with a damaged part.
- Store the product when it is not in use. Store it in a dry, secure place out of the reach of children. Inspect the tool for good working condition prior to storage and before re-use.
- Use only accessories that are recommended by the manufacturer for use with your product. Accessories that may be suitable for one product may create a risk of injury when used with another tool. Never use an accessory that has a lower operating speed or operating pressure than the tool itself.
- Keep guards in place and in working order. Never operate the product without the guards in place.

## **Specific Operation Warnings**

### **⚠WARNING**

#### **Your Welding Environment**

- Keep the environment you will be welding in free from flammable materials.
- Always keep a fire extinguisher accessible to your welding environment.
- Always have a qualified person install and operate this equipment.
- Make sure the area is clean, dry, and ventilated. Do not operate the welder in humid, wet, or poorly ventilated areas.
- Always have your welder maintained by a qualified technician in accordance with local, state and national codes.
- Always be aware of your work environment. Be sure to keep other people, especially children, away from you while welding.
- Keep harmful arc rays shielded from the view of others.

- Mount the welder on a secure bench or cart that will keep the welder secure and prevent it from tipping over or falling.

## ⚠WARNING

### WELDER'S CONDITION

- Check the ground cable, power cord, and welding cable to be sure the insulation is not damaged. Always replace or repair damaged components before using the welder.
- Check all components to ensure they are clean and in good operating condition before use.

## ⚠CAUTION

### During Operation

**Do not operate the welder if the output cable, electrode, torch, or any accessories are wet.** Do not immerse them in water. These components and the welder must be completely dry before attempting to use them.

- Follow the instructions in this manual.
- Keep the welder in the OFF position when not in use.
- Connect ground lead as close to the area being welded as possible to ensure a good ground.
- Do not allow any body part to come in contact with the welding electrode if you are in contact with the material being welded, ground, or electrode from another welder.
- Do not weld if you are in an awkward position. Always have a secure stance while welding to prevent accidents. Wear a safety harness if working above ground.
- Do not drape cables over or around your body.
- Wear a full coverage helmet with appropriate shade (see ANSI Z87.1 safety standard) and safety glasses while welding.
- Wear proper gloves and protective clothing to prevent your skin from being exposed to hot metals, UV, and IR rays.
- Do not overuse or overheat your welder. Allow proper cooling time between duty cycles.
- Keep hands and fingers away from moving parts.
- Do not point the torch at a body part of yours or anyone else's.
- Always use this welder in the rated duty cycle to prevent excessive heat and failure.

## ⚠WARNING

### ELECTRICAL SHOCK

**Electric arc welders can produce a shock** that can cause injury or death. Touching electrically live parts can cause fatal shocks and severe burns. While welding, all metal components connected to the wire are electrically hot. Poor ground connections are a hazard, so secure the ground lead before

welding.

- Wear dry protective apparel: coat, shirt, gloves and insulated footwear.
- Insulate yourself from the work piece. Avoid contacting the work piece or ground.
- Do not attempt to repair or maintain the welder while the power is on.
- Inspect all cables and cords for any exposed wire and replace immediately if found.
- Use only recommended replacement cables and cords.
- Always attach the ground clamp to the work piece or work table as close to the weld area as possible.
- Do not touch the welding wire and the ground or grounded work piece at the same time.
- Do not use a welder to thaw frozen pipes.

## **⚠WARNING**

### **FUMES AND GASES**

- Do not use plasma cutter in the presence of gasoline, diesel, propane, or other flammable liquids. Sparks created from the cutter may ignite liquids or fumes, causing an explosion and serious injury or death.
- Fumes emitted from the welding process displace clean air and can result in injury or death.
- Do not breathe in fumes emitted by the welding process. Make sure your breathing air is clean and safe.
- Work only in a well-ventilated area or use a ventilation device to remove welding fumes from the environment where you will be working.
- Do not weld on coated materials (galvanized, cadmium plated or containing zinc, mercury, or barium). They will emit harmful fumes that are dangerous to breathe. If necessary use a ventilator, respirator with air supply, or remove the coating from the material in the weld area.
- The fumes emitted from some metals when heated are extremely toxic. Refer to the material safety data sheet for the manufacturer's instructions.
- Do not weld near materials that will emit toxic fumes when heated. Vapors from cleaners, sprays, and degreasers can be highly toxic when heated.

## **⚠WARNING**

### **UV AND IR ARC RAYS**

**The welding arc produces ultraviolet (UV) and infrared (IR) rays that can cause injury to your eyes and skin.** Do not look at the welding arc without proper eye protection.

- Always use a helmet that covers your full face from the neck to top of head and to the back of each ear.
- Use a lens that meets ANSI standards and safety glasses. For welders under 160 amps output, use a shade 10 lens; for above 160 amps, use a shade 12. Refer to the ANSI standard Z87.1 for



more information.

- Cover all bare skin areas exposed to the arc with protective clothing and shoes. Flame-retardant cloth or leather shirts, coats, pants, or coveralls are available for protection.
- Use screens or other barriers to protect other people from the arc rays emitted from your welding.
- Warn people in your welding area when you are going to strike an arc so they can protect themselves.

## **⚠WARNING**

### **FIRE HAZARDS**

**Do not weld on containers or pipes that contain or have had flammable, gaseous, or liquid combustibles in them. Welding creates sparks and heat that can ignite flammable and explosive materials.**

- Do not operate any electric arc welder in areas where flammable or explosive materials are present.
- Remove all flammable materials within 35 feet of the welding arc.
- Take precautions to ensure that flying sparks do not cause fires or explosions in hidden areas, cracks, or areas you cannot see.
- Keep a fire extinguisher close in the case of fire.
- Wear garments that are oil-free with no pockets or cuffs that will collect sparks.
- Do not have on your person any items that are combustible, such as lighters or matches.
- Keep work lead connected as close to the weld area as possible to prevent any unknown, unintended paths of electrical current from causing electrical shock and fire hazards.
- To prevent any unintended arcs, cut the wire back to ¼" stick out after welding.

## **⚠CAUTION**

**Hot Materials** - Welded materials are hot and can cause severe burns if handled improperly.

- Do not touch welded materials with bare hands.
- Do not touch the torch nozzle after welding until it has had time to cool down.

## **⚠CAUTION**

### **Electromagnetic Field**

- Electromagnetic fields can interfere with various electrical and electronic devices such as pacemakers.
- Consult your doctor before using any electric arc welder or cutting device.
- Keep people with pacemakers away from your welding area when welding.

- Do not wrap cable around your body while welding.
- Wrap the torch and ground cable together whenever possible.
- Keep the torch and ground cables on the same side of your body.

#### **H.F. RADIATION can cause interference!**

- High-frequency (H.F.) can interfere with radio navigation, safety services, computers, and communications equipment.
- Have only qualified persons familiar with electronic equipment perform this installation.
- The user is responsible for having a qualified electrician promptly correct any interference problem resulting from the installation.
- If notified by the FCC about interference, stop using the equipment at once.
- Have the installation regularly checked and maintained.
- Keep high-frequency source doors and panels tightly shut, keep spark gaps at correct setting, and use grounding and shielding to minimize the possibility of interference.

#### **ARC welding can cause interference!**

- Electromagnetic energy can interfere with sensitive electronic equipment such as computers and computer-driven equipment such as robots.
- Be sure all equipment in the welding area is electromagnetically compatible.
- To reduce possible interference, keep weld cables as short as possible, close together, and down low, such as on the floor.
- Locate welding operation 100 yards from any sensitive electronic equipment.
- Be sure this welding machine is grounded.
- If interference still occurs, the user must take extra measures such as moving the welding machine, using shielded cables, using line filters, or shielding the work area.

## **⚠WARNING**

### **SHIELDING GAS CYLINDERS CAN EXPLODE**

**High pressure cylinders can explode if damaged; treat them carefully.**

- Never expose cylinders to high heat, sparks, open flames, mechanical shocks or arcs.
- Do not touch the cylinder with the MIG gun.
- Do not weld on the cylinder.
- Always secure cylinder upright to a cart or stationary object.
- Keep cylinders away from welding or electrical circuits.
- Use the proper regulators, gas hose, and fittings for the specific application.
- Do not look into the valve when opening it.
- Use a protective cylinder cap whenever possible.

## ⚠ CAUTION

### Proper Care, Maintenance, and Repair

- Always have the power disconnected when working on internal components.
- Do not touch or handle the PC board without being properly grounded with a wrist strap. Put the PC board in a static proof bag to move or ship.
- Do not put hands or fingers near moving parts such as the drive rolls of the fan.

## Main Parts of MP140Si



Figure 1

Reference	Subassembly
1	Digital Voltage and Amperage Meters
2	Voltage Control
3	MP140Si
4	Spool Gun/MIG Torch/Stick Welding Selector
5	Stop Timer On/Off Switch
6	Spot Time Control
7	Ground Cable & Clamp
8	MIG Torch

Reference	Subassembly
9	Gas Hose with Regulator/Flow Gauge
10	Electrode Holder & Cable
11	Wire Speed & Amperage Control

## Setting Up Equipment

### ⚠ WARNING

#### **ELECTRIC SHOCK CAN KILL!**

- High voltage danger from power source! Consult a qualified electrician for proper installation of receptacle. This welder must be grounded while in use to protect the operator from electrical shock.
- Do not remove the grounding prong or alter the plug in any way. Use only the supplied adapter between the welder's power cord and the power source receptacle. Make sure the POWER switch is OFF when connecting your welder's power cord directly to a properly grounded 120V, 20 amp input power supply.

1. **POWER REQUIREMENT 120V - AC** single phase 120V (110-130V) 50/60 HZ fused with a 20 amp time delayed fuse or circuit breaker is required. **DO NOT OPERATE THIS UNIT** if the **ACTUAL** power source voltage is less than 110 volts AC or greater than 130 volts AC.
2. **EXTENSION CORD** - We do not recommend an extension cord because of the voltage drop produced. This drop in voltage can affect the performance of the welder. If you need to use an extension cord, check with a qualified electrician and your local electrical codes for your specific area.
3. **INSTALL THE WIRE ROLLER** - The wire roller has been factory installed. However, check to make certain the correct wire groove is in place to accommodate the size of wire you are using. Open the wire feed compartment. Adjust the drive roller according to the following steps. See Figure 2 regarding the wire feeder structure:

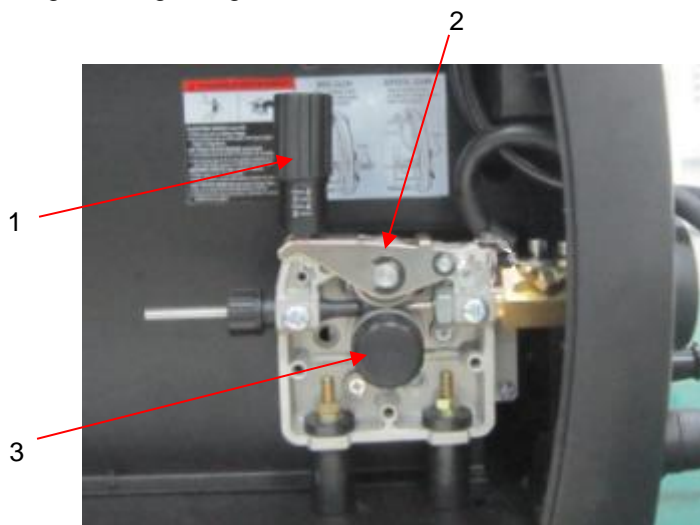

Figure 2

- a. Open the door to the welder drive compartment.

- b. Remove the drive tension by loosening the Drive Tension Adjuster (1) and moving the Drive Tension Adjuster away from the Drive Tension Arm (2). Lift the Drive Tension Arm away from the Drive Roller (3).
  - c. If there is wire already installed in the welder, roll it back onto the wire spool by hand-turning the spool clockwise. Be careful not to let all the wire come out of the rear end of the inlet guide tube. Hold onto it or the wire spool will unspool itself. Put the end of the wire into the hole on the outside edge of the wire spool and bend it over to hold the wire in place. Remove the spool of wire from the drive compartment of the welder.
  - d. Remove the drive roller by turning the drive roll knob (3) counter-clockwise. Carefully slide the drive roll assembly off of the drive shaft. This drive roll assembly consists of three pieces. The outer drive roll, inner drive roll, and a key. Be careful not to misplace the key.
  - e. Based on the wire diameter, select the correct groove. When installing the drive roller, the number stamped on the drive roller for the wire size you are using should be facing you. Push the Drive Roller onto the Drive Roller Shaft.
  - f. Reinstall the Drive Roller knob and tighten clockwise.
  - g. Close the door to the welder drive compartment.
4. INSTALL THE WIRE - We recommend the usage of .023 and .030 MIG wire, or .030 and .035 flux core wire, on this unit.
- a. Select welding wire - Both four-inch or eight-inch wire spools of .023, .030, or .035 wire can be used on this welder.
- NOTE:** Burn-through can occur if you attempt to weld mild or stainless steel thinner than 24 gauge.
- NOTE:** Remove all rusted wire from your wire spool. If the whole spool is rusty, discard it.
- b. Installing the wire.

## ⚠WARNING

### ELECTRIC SHOCK CAN KILL!

Always turn the power switch OFF and unplug the power cord from the AC power source before installing wire.

**NOTE:** Before installing, make sure that you have removed any old wire from the torch assembly. This will help to prevent the possibility of the wire jamming inside the gun liner.

**NOTE:** Be very careful when removing the welding nozzle. The contact tip on this welder is live whenever the torch trigger is pulled. Make certain power is turned OFF.

- i. Remove the nozzle and contact tip from the end of the torch assembly. See Figure 3.
- ii. Make sure the proper groove on the drive roller is in place for the wire installed. If not, change the drive roller as described in INSTALL THE WIRE ROLLER above.
- iii. Remove the packaging from the spool of wire and then identify the leading end of the wire secured on the edge of the spool. **DO NOT UNHOOK IT AT THIS TIME.**

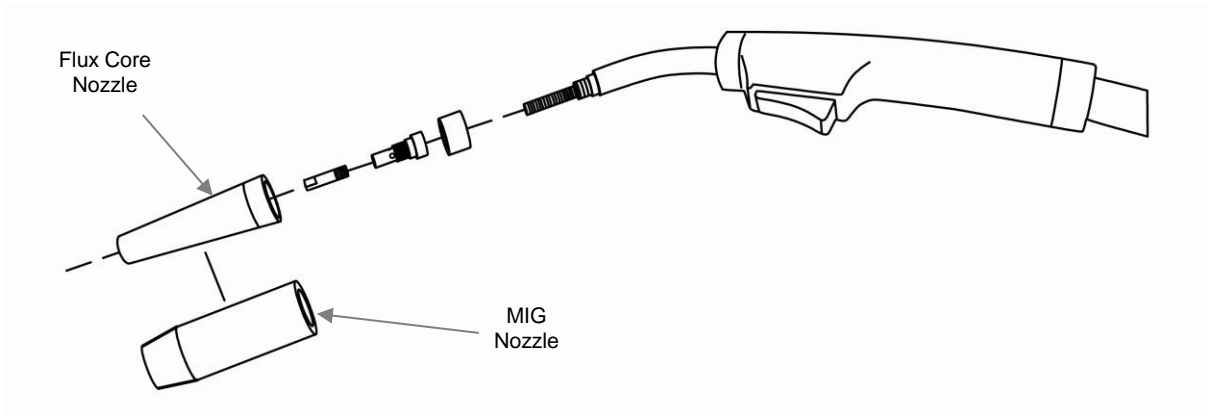

Figure 3

- iv. Place the spool on the spool hub so the wire will pull off the bottom of the spool. The welding wire should always come off the bottom of the spool into the drive mechanism. See Figure 4.

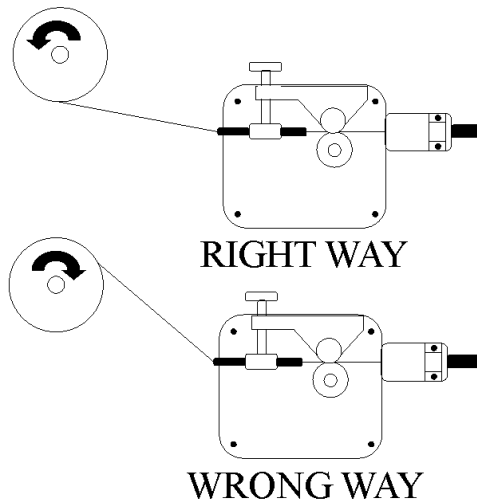

Figure 4

- v. The welder can use either 4 inch or 8 inch spools. See the following illustration for additional reference. The wing nut controls the tension on the spool.

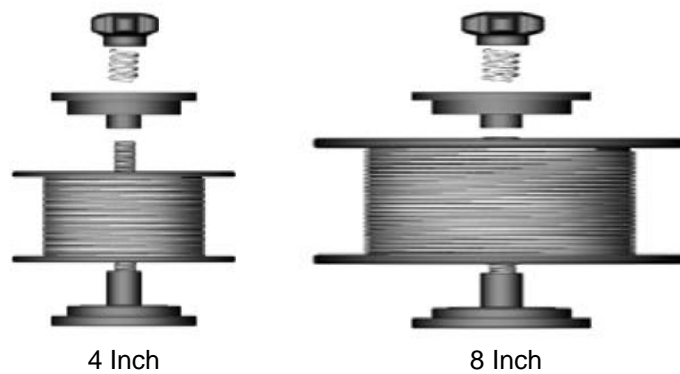

Figure 5

- vi. Setting the wire spool tension. a) Turn the spool of wire with one hand. b) Increase the spool tension by tightening (turn clockwise) the wing nut while turning the spool. Turn the spool while tightening the wing nut until the spool slows down and you feel a slight drag. Stop tightening the wing nut; you may need to repeat these steps until proper spool tension is achieved.
- vii. If TOO MUCH tension is applied to the wire spool, the wire will slip on the drive roller or will not be able to feed at all. If TOO LITTLE tension is applied, the spool of wire will want to unspool itself when the trigger is released. Readjust the spool tension using the wing nut as necessary to correct for either problem.
- viii. With the welder disconnected from the power source, remove the leading end of the wire from the spool. **Hold on to it securely**, so as not to allow unspooling or tangling of the wire as it will result in tangled wire and feeding problems.
- ix. Cut off any bent portion of the wire using a wire cutter.
- x. Loosen the tension adjusting knob holding the drive tension arm in place and lift the tension arm up off the drive roller.
- xi. Insert the wire into the inlet guide tube and feed it across the drive roller and into the torch assembly about six inches.

**⚠CAUTION**

- Make certain that the welding wire is actually going into the torch liner. If not, the wire will jam up in the mechanism.

- xii. Line the wire up with the correct groove in the drive roller. Place the drive tension arm back above the drive roller.
- xiii. Place the drive tension adjustment arm back in place.
- xiv. Tighten (turn clockwise) the drive tension adjusting knob until the tension roller is applying enough force on the wire to prevent it from slipping in the drive rollers. **DO NOT OVER TIGHTEN.**
- xv. **NOW YOU CAN LET GO OF THE WIRE.**
- xvi. Plug in the welder power cord and turn the welder ON. Set the voltage switch to the voltage setting recommended for the gauge metal that is to be welded. Refer to the set-up chart on the back side of the drive compartment door.

**⚠CAUTION**

- The welding wire is electrically hot when the power is on and the torch trigger is activated.

- xvii. Set the WIRE SPEED control to the middle of the wire speed range.
- xviii. Straighten the MIG torch cable and pull the trigger in the gun handle to feed the wire through the torch assembly. When at least one inch of the wire sticks out past the end of the torch, release the trigger.
- xix. Turn the power switch to the OFF position.
- xx. Select a contact tip stamped with the same diameter as the wire being used. **NOTE:** Due to inherent variances in flux core welding wire, it may be

necessary to use a contact tip one size larger than your flux core wire, if wire jams occur.

- xxi. Slide the contact tip over the wire (protruding from the end of the torch). Thread the contact tip into the end of the torch and hand-tighten securely.
- xxii. Install the nozzle on the torch assembly.
- xxiii. Cut off excess wire that extends past the end of the nozzle more than 1/4 inch.
- xxiv. Turn the welder ON.

## 5. SETTING THE DRIVE ROLL TENSION

### **⚠WARNING**

- Arc flash can injure eyes! To reduce the risk of arc flash, make certain that the wire coming out of the end of the torch does not come in contact with the work piece, ground clamp, or any grounded material during the drive tension setting process or arcing will occur.

- a. Press the trigger on the torch.
- b. Turn the drive tension adjustment knob clockwise until the wire seems to feed smoothly without slipping.

## 6. GAS INSTALLATION

### **⚠WARNING**

**Shielding gas cylinders and high pressure cylinders can explode if damaged, so treat them carefully.**

- Never expose cylinders to high heat, sparks, open flames, mechanical shocks, or arcs.
  - Do not weld on the cylinder.
  - Always secure the cylinder upright to a cart or stationary object.
  - Keep cylinders away from welding or electrical circuits.
  - Use the proper regulators, gas hoses, and fittings for the specific application.
- a. Polarity Changing - When MIG wire is used, shielding gas is required and the polarity on this unit needs to be electrode positive.
    - i. Electrode Positive for MIG Welding - The Weld Power Cable (see Figure 8) should be connected to the positive (+) weld output connection on the front of the machine. The ground cable would then be connected to the negative (-) weld output connection.
    - ii. Electrode Negative for Flux Core Welding - The Weld Power Cable should be connected to the negative (-) weld output connection on the front of the machine. The ground cable would then be connected to the positive (+) weld output connection. Refer to the polarity setting label inside the wire compartment.
    - iii. Connect one end of the gas hose to the gas hose connection on the back of the welder. Use a wrench to snug up the connection.



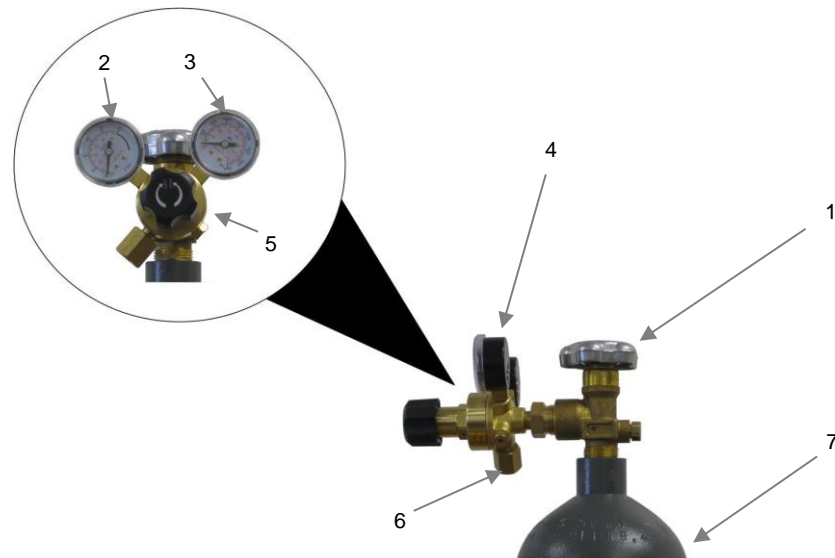

Reference	Subassembly
1	Gas Bottle Valve
2	Gas Flow Gauge (Set at 20 CFH)
3	Gas Pressure Gauge
4	Regulator
5	Gas Flow Adjuster
6	Gas Hose Connection
7	Gas Cylinder

Figure 6

- iv. Connect the other end of the gas hose to the gas hose connection on the supplied regulator/flow gauge. Use a wrench to snug up the connection.
- v. Before installing the regulator, it is good practice to make certain no debris is in the gas bottle connection. Rotate the bottle so the gas connection is not pointing toward you or any other person. Turn the valve on the gas bottle clockwise and quickly close. This quick thrust of gas will clear any debris in the connection. Connect the regulator to the gas bottle connection. Use a wrench to snug up the connection.
- vi. Open the Gas Bottle Valve on the cylinder of gas.
- vii. Turn the Gas Flow Adjuster on the regulator so that the gas flow rate is set at approximately 20 CFH. Make certain you are reading the correct scale on the gauge.

**NOTE:** Slowly open the cylinder valve by turning it counter-clockwise until the cylinder pressure gauge registers on the first gauge of the regulator. Turn the adjustment knob clockwise (right) slowly to increase gas flow to 20 CFH. To reduce the gas flow, turn the adjustment counter-clockwise (left). The gas valve is located on the back panel of the welder and activated by the trigger. Gas flow should be heard when the trigger is activated. No gas flow will result in a harsh arc with excessive spatter; a smooth weld bead will be difficult to obtain. Avoid unnecessary gas loss by closing the tank valve when finished welding.

viii. Gas Selection

Different materials require different shielding gases when MIG welding. (Refer to the set up chart inside the wire feed compartment.)

**Mild Steel:** Use 75% Argon and 25% CO2 for reduced spatter and reduced penetration for thinner materials. DO NOT USE Argon gas concentrations higher than 75% on steel. The result will be extremely poor penetration,

porosity, and brittleness of weld.

**Mild Steel:** Use CO<sub>2</sub> for deeper penetration but increased spatter. (A CO<sub>2</sub> regulator adapter will be needed.)

**Stainless Steel:** Use a mixed gas consisting of Helium, Argon, and CO<sub>2</sub>.

**Aluminum or Bronze:** Use 100% Argon.

## Assembly Instructions

### ⚠ WARNING

#### ELECTRIC SHOCK CAN KILL!

- Always turn the power switch OFF and unplug the power cord from the AC power source before installing wire.

#### MIG TORCH ASSEMBLY

1. Locate the wing nut retaining bolt inside the front panel on the Drive System (Figure 1). Loosen the retaining bolt.

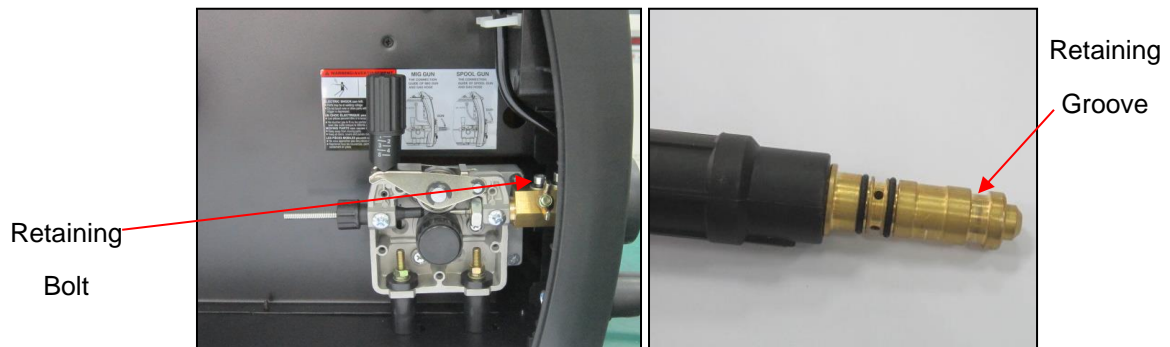

Figure 7

2. Make note of the retaining groove on the back end of the MIG torch (Figure 7).



Figure 8

3. Insert the back end of the MIG torch into the MIG socket on the front of your machine (Figure 8). Make certain to completely slide the torch all the way in. Slightly twist to assist with pushing the torch to the back of the receptacle. The retaining bolt can then be tightened,

- making certain the bolt sets down into the retaining groove on the back of the MIG torch.
4. Connect the 5-Pin trigger connection on the MIG torch to the 5-Pin trigger receptacle on the front panel (Figure 8).
  5. Connect the ground cable to the negative (-) weld output connection for MIG welding. If welding with self-shielded flux core, connect the ground cable to the positive (+) weld output connection and move the Weld Power Cable to the negative (-) weld output connection.
  6. Make certain the SPOOL GUN/MIG TORCH/STICK SELECTOR on the front panel is switched into the MIG TORCH position (see Figure 1).

#### OPTIONAL SPOOL GUN ASSEMBLY

1. This unit is set-up to accept the Quick Draw Spool gun only.
2. The Quick Draw Spool Gun has three connection points at the back of the spool gun (Figure 9).
  - 1) The gas connection is a slide-on quick connector.
  - 2) The weld power connection has a round ring connection.
  - 3) The trigger connection is the 5-Pin snap-on connector.



Figure 9

3. We recommend removing the MIG torch when the Spool Gun is connected to avoid accidental arcing. Loosen the wing nut retaining bolt and slide the MIG torch out of the front of the machine. Disconnect the 5-Pin trigger connection on the front of the machine.
4. Carefully slide the gas connector and the weld power connection through the weld cable access opening in the front of the machine (Figure 10).

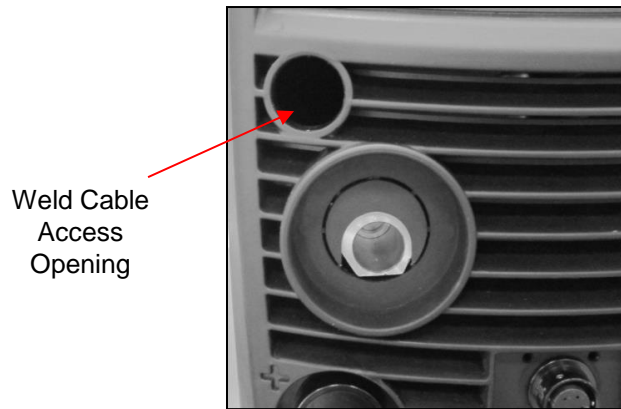

Figure 10

5. Open the wire compartment door.
6. Connect the gas connection quick connector to the gas connector (1) on the back panel of the wire compartment.
7. Connect the weld power connection to the bolt on the top of the MIG connector (2).
8. Connect the 5-Pin trigger connector to the 5-Pin receptacle on the front of the machine (3).
9. Make certain the SPOOL GUN/MIG TORCH/STICK SELECTOR on the front panel is switched into the SPOOL GUN position (Figure 8).

#### DC STICK WELDING ASSEMBLY

##### ⚠ CAUTION

Be aware that the ELECTRODE HOLDER will be electrically HOT when the Input Power Switch on the welder is turned ON.

1. Install the ground cable quick connector to the negative (-) Weld Output Connector (Figure 3).
2. Secure the ground clamp to the work piece.
3. Install the electrode cable quick connector to the positive (+) Weld Output Connector.
4. Make certain the SPOOL GUN/MIG TORCH/STICK SELECTOR on the front panel is switched into the STICK position (Figure 8).

#### OPTIONAL TIG TORCH ASSEMBLY

##### ⚠ CAUTION

Be aware that the TIG TORCH will be electrically HOT when the Input Power Switch on the welder is turned ON.

1. Remove the ground cable and the electrode holder from the weld output connections. Install the ground cable to the positive (+) weld output connection (Figure 8).
2. Secure the ground clamp to the work piece
3. Connect a regulator to a bottle of ARGON gas. Then connect the gas connection from the TIG torch to the regulator.
4. Connect the TIG torch weld cable to the negative (-) weld output connection.

5. Set the desired amperage on the amperage control knob on the front panel of the welder.
6. Turn on the input power switch on the welder.
7. Turn on the regulator on the bottle of shielding gas and adjust the regulator to approximately 20 CFH. Open the shielding gas valve on the torch to start the flow of shielding gas.

## Before Each Use

### **⚠WARNING**

#### **ELECTRIC SHOCK CAN KILL!**

- Touching live electrical parts can cause fatal shocks or severe burns. Do not touch live electrical parts.
- Wear dry, hole-free insulating gloves and body protection.
- Disconnect input power before installing, maintaining or servicing this equipment. Lockout/tag out input power according to OSHA 29 CFR 1910.147.

1. Review the contents of this manual and follow all safety warnings and cautions.
2. Inspect all cords and power cables. Replace any cords or power cables that are damaged or cracked.
3. Make certain your equipment is in good working order.
4. Make sure the area is clean, dry, and ventilated. Do not operate the welder in humid, wet, or poorly ventilated areas.
5. Always be aware of your work environment. Be sure to keep other people, especially children, away from you while welding.

## Operating Instructions

### **⚠WARNING**

#### **High voltage danger from power source!**

- Consult a qualified electrician for proper installation of receptacle at the power source. This welder must be grounded while in use to protect the operator from electrical shock. If you are not sure if your outlet is properly grounded, have it checked by a qualified electrician. Do not cut off the grounding prong or alter the plug in any way and do not use any adapter, other than the supplied adapter, between the welder's power cord and the power source receptacle. Make sure the power switch is OFF, then connect your welder's power cord to a properly grounded 120 VAC (110V - 130V), 60 HZ, single phase, 20 amp power source.

#### **MIG OPERATION**

1. **POWER SWITCH** - The power switch supplies electrical current to the welder. Whenever the power switch is in the ON position, the welding circuit is activated. ALWAYS turn the power switch to the OFF position and unplug the welder before performing any maintenance.
2. **VOLTAGE SELECTOR** - The voltage selector controls the welding voltage/heat. This unit has an infinite voltage control. Refer to the label inside the welder side door for recommended voltage selector settings for your welding job.
3. **WIRE SPEED CONTROL** - The wire speed control adjusts the speed at which the wire is fed out of the welding torch. The wire speed needs to be closely matched (tuned-in) to the rate at

which it is being melted off. Some things that affect wire speed selection are the type and diameter of the wire being used, the heat setting selected, and the welding position to be used. Refer to the label inside the welder side door for recommended wire speed settings for your welding job.

**NOTE:** The wire will feed faster without an arc. When an arc is being drawn, the wire speed will slow down.

4. **HOLDING THE TORCH** - The best way to hold the welding torch is the way it feels most comfortable to you. While practicing to use your new welder, experiment holding the torch in different positions until you find the one that seems to work best for you.
5. **POSITION OF THE TORCH TO THE WORK PIECE** - There are two angles of the torch nozzle in relation to the work piece that must be consider when welding.
  - a. Angle A can be varied, but in most cases the optimum angle will be 60 degrees, the point at which the torch angle is parallel to the work piece. If angle A is increased, penetration will increase. If angle A is decreased, penetration will decrease also.
  - b. Angle B can be varied for two reasons: to improve the availability to see the arc in relation to the weld puddle and to direct the force of the arc.

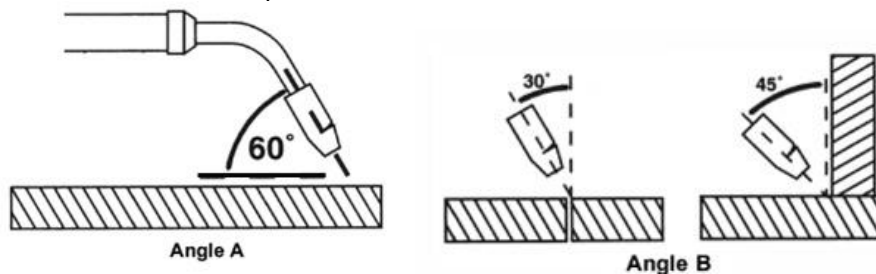

- c. **DISTANCE FROM THE WORK PIECE** - If the nozzle is held off the work piece, the distance between the nozzle and the work piece should be kept constant and should not exceed 1/4 inch or the arc may begin sputtering, signaling a loss in welding performance.
- d. **TUNING IN THE WIRE SPEED** - **This is one of the most important parts of wire welder operation and must be done before starting each welding job or whenever the voltage setting or wire diameter is changed.**

### **⚠WARNING**

#### **EXPOSURE TO A WELDING ARC IS EXTREMELY HARMFUL TO THE EYES AND SKIN!**

- Prolonged exposure to the welding arc can cause blindness and burns. Never strike an arc or begin welding until you are adequately protected. Wear flame-proof welding gloves, a heavy long sleeved shirt, trousers without cuffs, high topped shoes, and an ANSI approved welding helmet.

- e. Connect the Ground Clamp to a scrap piece of the same type of material which you will be welding. It should be equal to or greater than the thickness of the actual work piece, and free of oil, paint, rust, etc.
- f. Select a heat setting.
- g. Hold the torch in one hand. Hold the wire just off the work piece. (See **HOLDING THE TORCH** in a previous section if you are uncertain of the angle at which you will be welding.)
- h. Set the wire feed speed based on the thickness of material and the set-up chart on the back side of the wire feeder door.
- i. Lower your welding helmet and pull the trigger on the torch and let the wire feed into the work piece to start an arc, and then begin to drag the torch toward you.
- j. **LISTEN!** If the arc is sputtering, increase the wire speed slightly and try again. Continue increasing the wire speed adjustment until you achieve a smooth buzzing sound. If the wire seems to "pound" into the work piece, decrease wire speed slightly and try again. Use the wire speed control to slightly increase or decrease the heat and penetration for a given voltage setting by increasing or decreasing the wire speed

slightly. Repeat this tune-in procedure if you select a new voltage setting, a different wire diameter, or a different roll of wire.

## 6. WELDING TECHNIQUES

### ⚠WARNING

#### EXPOSURE TO A WELDING ARC IS EXTREMELY HARMFUL TO THE EYES AND SKIN!

- Prolonged exposure to the welding arc can cause blindness and burns. Never strike an arc or begin welding until you are adequately protected. Wear flame-proof welding gloves, a heavy long sleeved shirt, trousers without cuffs, high topped shoes, and an ANSI approved welding helmet.

### ⚠WARNING

#### ELECTRIC SHOCK CAN KILL!

- To prevent ELECTRIC SHOCK, do not perform any welding while standing, kneeling, or lying directly on the grounded workpiece.

- Moving the Torch** - Torch travel refers to the movement of the torch along the weld joint and is broken into two elements: direction and speed. A solid weld bead requires that the welding torch be moved steadily and at the right speed along the weld joint. Moving the torch too fast, too slow, or erratically will prevent proper fusion or create a lumpy, uneven bead.

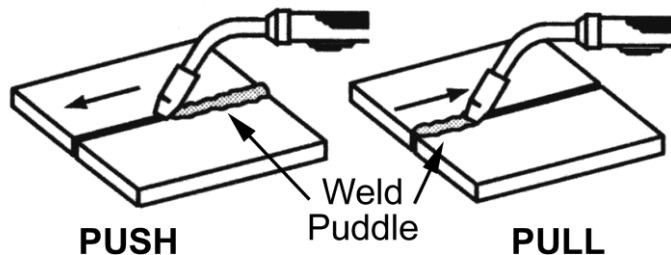

**Travel direction** is the direction the torch is moved along the weld joint in relation to the weld puddle. The torch is either PUSHED into the weld puddle or PULLED away from the weld puddle.

For most welding jobs you will pull the torch along the weld joint to take advantage of the greater weld puddle visibility.

**Travel speed** is the rate at which the torch is being pushed or pulled along the weld joint. For a fixed heat setting, the faster the travel speed, the lower the penetration and the lower and narrower the finished weld bead. Likewise, the slower the travel speed the deeper the penetration and the higher and wider the finished weld bead.

- Types of Welding Beads** - As you become more familiar with your new welder and better at laying some simple weld beads, you can begin to try some different weld bead types.

The STRINGER BEAD is formed by traveling with the torch in a straight line while keeping the wire and nozzle centered over the weld joint. See following illustration.

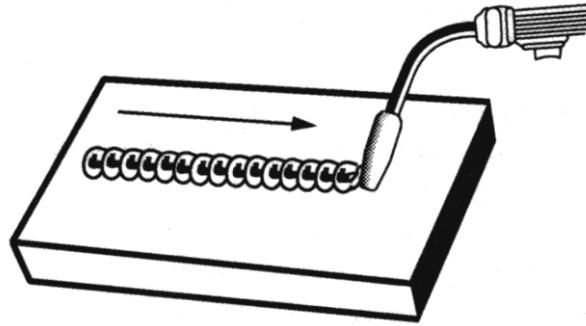

The WEAVE BEAD is used when you want to deposit metal over a wider space than would be possible with a stringer bead. It is made by weaving from side to side while moving with the torch. It is best to hesitate momentarily at each side before weaving back the other way. See the following illustration.

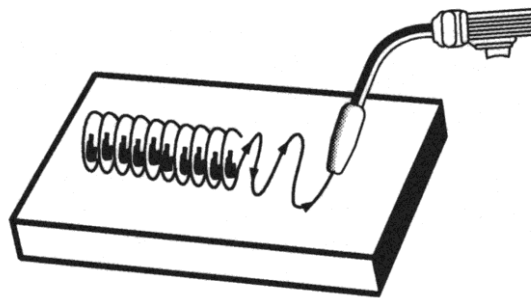

c. **Welding Positions**

The FLAT POSITION is the easiest of the welding positions and is most commonly used. It is best if you can weld in the flat position, if at all possible, as good results are easier to achieve in this position.

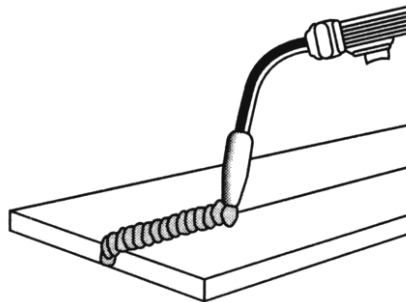

The HORIZONTAL POSITION is performed very much the same as the flat weld except that angle B (see HOLDING THE TORCH) is such that the wire, directed more toward the metal above the weld joint, is to help prevent the weld puddle from running downward while still allowing slow enough travel speed. A good starting point for angle B is about 30 degrees DOWN from being perpendicular to the work piece.

VERTICAL POSITION It is easier for many people to pull the torch from top to bottom. It can be difficult to prevent the puddle from running downward. Pushing the torch from bottom to top may provide better puddle control and allow slower rates of travel speed to achieve deeper penetration. When vertical welding, angle B (see HOLDING THE TORCH) is usually always kept at zero, but angle A will generally range from 45 to 60 degrees to provide better puddle control.





The OVERHEAD POSITION is the most difficult welding position. Angle A (see HOLDING THE TORCH) should be maintained at 60 degrees. Maintaining this angle will reduce the chances of molten metal falling into the nozzle. Angle B should be held at zero degrees so that the wire is aiming directly into the weld joint. If you experience excessive dripping of the weld puddle, select a lower heat setting. Also, the weave bead tends to work better than the stringer.

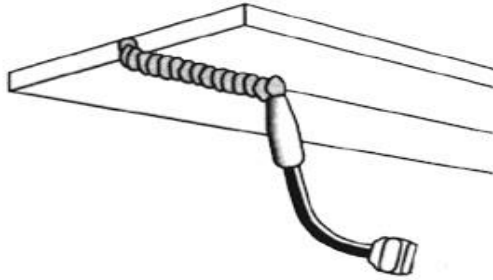

## Multiple Pass Welding

**Butt Weld Joints** When butt welding thicker materials, you will need to prepare the edges of the material to be joined by grinding a bevel on the edge of one or both pieces of the metal being joined. When this is done, a “V” is created between the two pieces of metal that will have to be welded closed. In most cases more than one pass or bead will need to be laid into the joint to close the “V”.

Laying more than one bead into the same weld joint is known as a multiple-pass weld.

The illustration below shows the sequence for laying multiple pass beads into a single “V” butt joint.

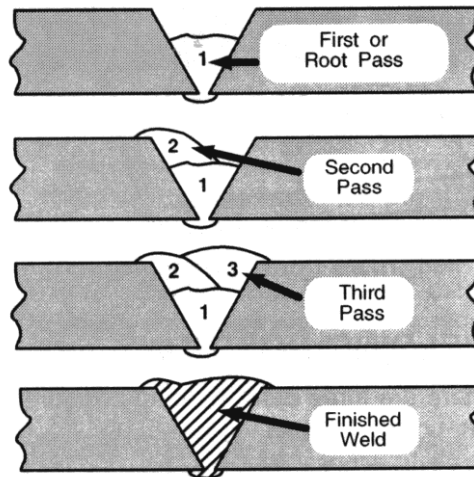

**NOTE:** WHEN USING SELF-SHIELDING FLUX-CORE WIRE it is very important to thoroughly chip and brush the slag off each completed weld bead before making another pass or the next pass will be of poor quality.

**Fillet Weld Joints** Most fillet weld joints, on metals of moderate to heavy thickness, will require multiple pass welds to produce strong joint. The following illustration will show the sequence of laying multiple pass beads into a T fillet joint and a lap fillet joint.

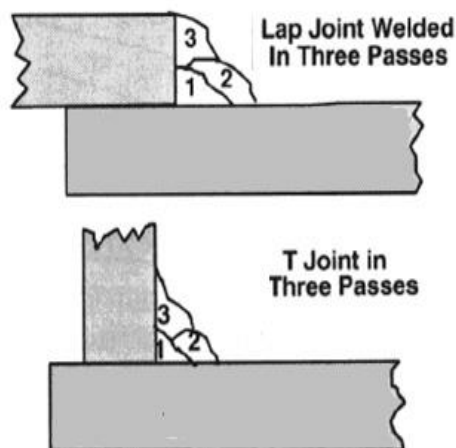

d. **Spot Welding**

There are three methods of spot welding: Burn-Through, Punch and Fill, and Lap. Each has advantages and disadvantages depending on the specific application as well as personal preference.



- i. The BURN-THROUGH METHOD welds two overlapped pieces of metal together by burning through the top piece and into the bottom piece. With the burn-through method, larger wire diameters tend to work better than smaller diameters. Wire diameters that tend to work best, with the burn-through method are 0.035 inch self-shielding flux-core wire. Do not use 0.030 inch self-shielding flux core wires when using the burn-through method unless the metal is VERY thin or excessive filler metal build-up and minimal penetration is acceptable. Always select the HIGH heat setting with the burn-through method and tune in the wire speed prior to making a spot weld.
- ii. The PUNCH AND FILL METHOD produces a weld with the most finished appearance of the three spot weld methods. In this method, a hole is punched or drilled into the top piece of metal and the arc is directed through the hole to penetrate into the bottom piece. The puddle is allowed to fill up the hole leaving a spot weld that is smooth and flush with the surface of the top piece. Select the wire diameter, heat setting, and tune in the wire speed as if you were welding the same thickness material with a continuous bead.
- iii. The LAP SPOT METHOD directs the welding arc to penetrate the bottom and top pieces, at the same time, right along each side of the lap joint seam. Select the wire diameter, heat setting, and tune in the wire speed as if you were welding the same thickness material with a continuous bead.

7. SPOT WELDING INSTRUCTIONS

- a. Select the wire diameter and heat setting recommended above for the method of spot welding you intend to use.
- b. Tune in the wire speed as if you were going to make a continuous weld.
- c. Hold the nozzle piece completely perpendicular to and about 1/4 inch off the work piece.
- d. Pull the trigger on the torch and release it when it appears that the desired penetration has been achieved.
- e. Make practice spot welds on scrap metal, varying the length of time you hold the trigger, until a desired spot weld is made.
- f. Make spot welds on the actual work piece at desired locations.

## DC STICK OPERATION

### ⚠ WARNING

#### High voltage danger from power source!

- Consult a qualified electrician for proper installation of receptacle at the power source. This welder must be grounded while in use to protect the operator from electrical shock. If you are not sure if your outlet is properly grounded, have it checked by a qualified electrician. Do not cut off the grounding prong or alter the plug in any way and do not use any adapter, other than the supplied adapter, between the welder's power cord and the power source receptacle. Make sure the power switch is OFF, then connect your welder's power cord to a properly grounded 120 VAC (110V - 130V), 60 HZ, single phase, 20 amp power source.

#### 1. SETTING UP THE WORK PIECE

- Welding positions - There are two basic positions, for welding: Flat and Horizontal. Flat welding is generally easier, faster, and allows for better penetration. If possible, the work piece should be positioned so that the bead will run on a flat surface.
- Preparing the joint- Before welding, the surface of work piece needs to be free of dirt, rust, scale, oil, or paint or it will create brittle and porous welds. If the base metal pieces to be joined are thick or heavy, it may be necessary to bevel the edges with a metal grinder, the correct bevel should be around 60 degree. See the following illustration:

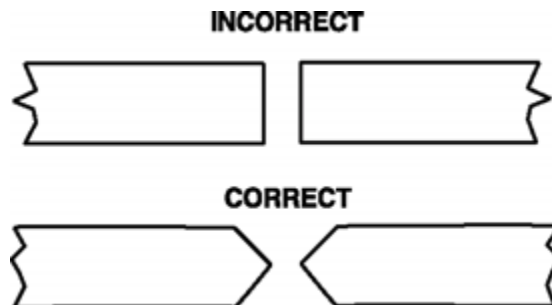

Based on different welding positions, there are different welding joints. See the following illustration for more information.

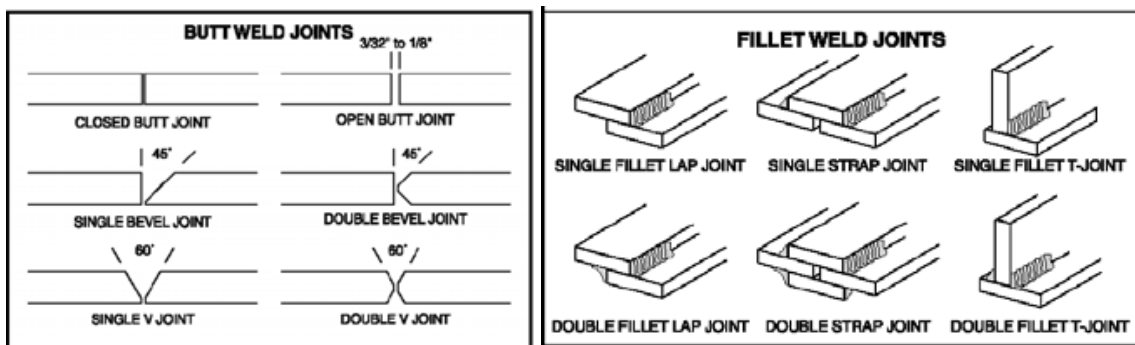

## 2. GROUND CLAMP CONNECTION

Clear any dirt, rust, scale, oil, or paint on the ground clamp. Make certain you have a good solid ground connection. A poor connection at the ground clamp will waste power and heat. Make sure the ground clamp touches the metal.

## 3. ELECTRODE

The welding electrode is a rod coated with a layer of flux. When welding, electrical current flows between the electrode (rod) and the grounded metal work piece. The intense heat of the arc between the rod and the grounded metal melts the electrode and the flux.

## 4. SELECTING THE PROPER ELECTRODE

There is no golden rule that determines the exact rod or heat setting required for every situation. The type and thickness of metal and the position of the work piece determine the electrode type and the amount of heat needed in the welding process. Heavier and thicker metals require more amperage. It is best to practice your welds on scrap metals which match the metal you intend to work with to determine correct heat setting and electrode choice. See the following trouble shooting tips to determine if you are using a correct electrode.

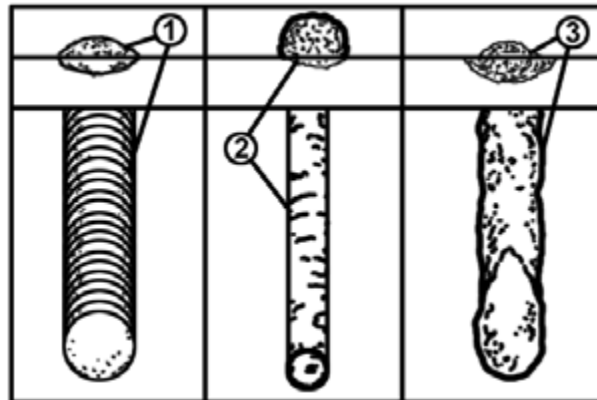

- a. When the proper rod is used:
  - i. The bead will lay smoothly over the work without ragged edges.
  - ii. The base metal puddle will be as deep as the bead that rises above it.
  - iii. The welding operation will make a crackling sound similar to the sound of eggs frying.
- b. When a rod is too small is used:
  - i. The bead will be high and irregular.
  - ii. The arc will be difficult to maintain.
- c. When the rod is too large:
  - i. The arc will burn through light metals.
  - ii. The bead will undercut the work.
  - iii. The bead will be flat and porous.
  - iv. The rod may be freeze or stick to the work piece.

**Note:** The rate of travel over the work also affects the weld. To ensure proper penetration and enough deposit of rod, the arc must be moved slowly and evenly along the weld seam.

## 5. SETTING THE AMPERAGE CONTROL

The welder has an infinite current control. It is capable of welding with electrodes up to 3/32" diameter. It is best to practice your welds on scrap metals which match the metals you intend to work with to determine correct setting for your job. The electrode type and the thickness of

the work piece metal determine the amount of heat needed in the welding process. Heavier and thicker metals require more voltage (amperage), whereas lighter and thinner metals require less voltage (amperage). Consult the welding electrode packaging for recommended welding amperage range.

## 6. WELDING TECHNIQUES

The best way to teach yourself how to weld is with short periods of practice at regular intervals. All practice welds should be done on scrap metal that can be discarded. Do not attempt to make any repairs on valuable equipment until you have satisfied yourself that your practice welds are of good appearance and free of slag or gas inclusions.

### a. Holding the electrode

The best way to grip the electrode holder is the way that feels most comfortable to you. Position the electrode to the work piece when striking the initial arc it may be necessary to hold the electrode perpendicular to the work piece. Once the arc is started the angle of the electrode in relation to the work piece should be between 10 and 30 degrees. This will allow for good penetration, with minimal spatter.

## ⚠WARNING

### EXPOSURE TO A WELDING ARC IS EXTREMELY HARMFUL TO THE EYES AND SKIN!

- Prolonged exposure to the welding arc can cause blindness and burns. Never strike an arc or begin welding until you are adequately protected. Wear flame-proof welding gloves, a heavy long sleeved shirt, trousers without cuffs, high topped shoes, and an ANSI approved welding helmet.

### b. Striking the arc

Scratch the work piece with the end of electrode to start arc and then raise it quickly about 1/8 inch gap between the rod and the work piece, see following illustration:

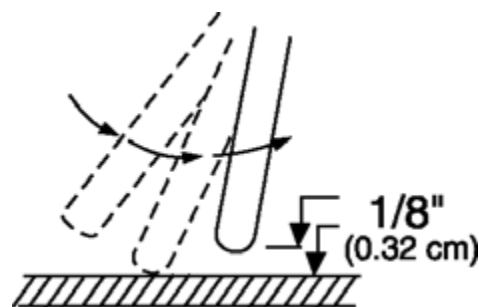

It is important that the gap be maintained during the welding process and it shouldn't be too wide or too narrow. If it's too narrow, the rod will stick to the work piece. If it's too wide, the arc will be extinguished. It needs much practice to maintain the gap. Beginners may get sticker or arc extinguishing. When the rod is stuck to the work piece, gently rock it back and forth to separate them. If not, a short circuit will occur and it will break the welder. A good arc is accompanied by a crisp, cracking sound (eggs frying). To lay a weld bead, only two movements are required: downward (as the electrode is consumed) and in the direction the weld is to be laid, as in the following illustration:

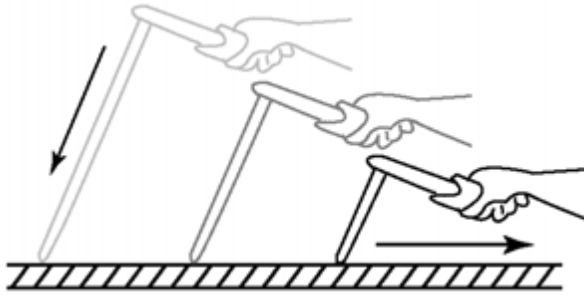

c. Types of weld bead

The following paragraphs discuss the most commonly used arc welding beads. The stringer bead is formed by traveling with the electrode in a straight line while keeping the electrode centered over the weld joint.

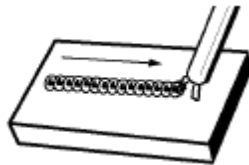

Stringer Bead

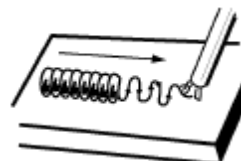

Weave Bead

The weave bead is used when you want to deposit metal over a wider space than would be possible with a stringer bead. It is made by weaving from side to side while moving with the electrode. It is best to hesitate momentarily at each side before weaving back the other way.

d. Welding position

Flat position is the easiest of the welding positions and is most commonly used. It is best if you can weld in the flat position if at all possible as good results are easier to achieve in this position.



Flat Position

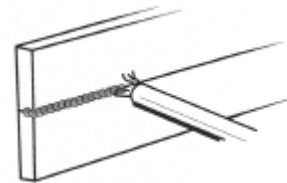

Horizontal Position

The horizontal position is performed very much the same as the flat weld except that the angle is different such that the electrode, and therefore the arc force, is directed more toward the metal above the weld joint. This more direct angle helps prevent the weld puddle from running downward while still allowing slow enough travel speed to achieve good penetration. A good starting point for your electrode angle is about 30 degrees DOWN from being perpendicular to the work piece.

e. Judge the good weld bead

When the trick of establishing and holding an arc has been learned, the next step is learning how to run a good bead. The first attempts in practice will probably fall short of acceptable weld beads. Too long of an arc will be held or the travel speed will vary from slow to fast. See the following illustration:

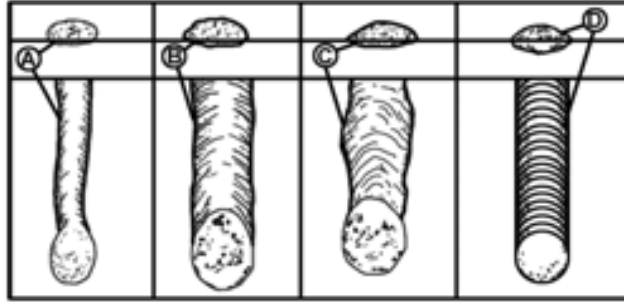

- A. Weld speed is too fast.
- B. Weld speed is too slow.
- C. Arc is too long.
- D. Ideal weld.

A solid weld bead requires that the electrode be moved slowly and steadily along the weld seam. Moving the electrode rapidly or erratically will prevent proper fusion or create a lumpy, uneven bead.

### ⚠WARNING

#### **ELECTRIC SHOCK CAN KILL!**

To prevent ELECTRIC SHOCK, do not perform any welding while standing, kneeling, or lying directly on the grounded workpiece.

f. Finish the bead

As the coating on the outside of the electrode burns off, it forms an envelope of protective gases around the weld. This prevents air from reaching the molten metal and creating an undesirable chemical reaction. The burning coating, however, forms slag. The slag formation appears as an accumulation of dirty metal scale on the finished weld. Slag should be removed by using a chipping hammer.

### ⚠WARNING

#### **PEENING THE SLAG FROM A WELD JOINT CAUSES SMALL CHIPS OF METAL TO FLY THROUGH THE AIR!**

- Metallic chips flying through the air can cause eye injury or injury to other parts of the head, hands or exposed portions of the body. Wear goggles or safety glasses with side shields and protect the hands and other exposed parts of the body with protective garments, or if possible, work with a shield between the body and the work piece.

Strain is created in the metal due to the intense heat the arc produces while welding. Peening the weld not only removes the scale left behind in the welding but relieves the internal strains developed by the heating and cooling process.



## DC TIG OPERATION

### ⚠WARNING

#### High voltage danger from power source!

- Consult a qualified electrician for proper installation of receptacle at the power source. This welder must be grounded while in use to protect the operator from electrical shock. If you are not sure if your outlet is properly grounded, have it checked by a qualified electrician. Do not cut off the grounding prong or alter the plug in any way and do not use any adapter, other than the supplied adapter, between the welder's power cord and the power source receptacle. Make sure the power switch is OFF, then connect your welder's power cord to a properly grounded 120 VAC (110V - 130V), 60 HZ, single phase, 20 amp power source.

### WARNING

#### EXPOSURE TO A WELDING ARC IS EXTREMELY HARMFUL TO THE EYES AND SKIN!

- Prolonged exposure to the welding arc can cause blindness and burns. Never strike an arc or begin welding until you are adequately protected. Wear flame-proof welding gloves, a heavy long sleeved shirt, trousers without cuffs, high topped shoes, and an ANSI approved welding helmet.

### ⚠CAUTION

Be aware that the TIG torch will be electrically HOT when the Input Power Switch on the welder is turned on.

1. Remove the ground cable and the electrode holder from the weld output connections. Install the ground cable to the Positive (+) weld output connection.
2. Secure the ground clamp to the work piece.
3. Connect a regulator to a bottle of ARGON gas. Then connect the gas connection from the TIG torch to the regulator.
4. Connect the TIG torch weld cable to the Negative (-) weld output connection.
5. Set desired amperage on the amperage control knob on the front panel of the welder.
6. Turn on the input power switch on the welder.
7. Turn on the regulator on the bottle of shielding gas and adjust the regulator to approximately 20 CFH. Then open the shielding gas valve on the torch to start the flow of shielding gas.
8. Follow these steps for striking an arc while TIG welding.
  - a) Open the shielding gas valve on the torch handle to begin gas flow.
  - b) Rest the TIG torch nozzle on the work piece taking care to not touch the installed tungsten electrode.

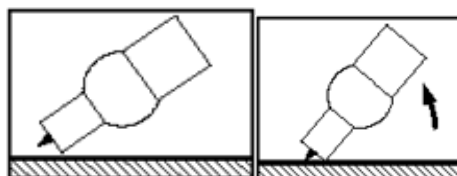

- c) Twist the torch to make contact between the work piece and the tungsten.

- d) Lift torch away from the work piece about 1/8 inch.

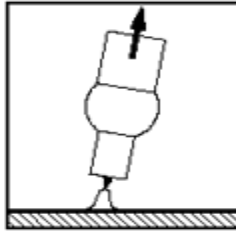

- e) Move down the joint to be welded by pushing the torch.  
f) Insert filler metal in the leading edge of the weld puddle as needed.

### After Each Use

#### ⚠CAUTION

**Hot Materials** - Welded materials are hot and can cause severe burns if handled improperly.

- Do not touch welded materials with bare hands.
- Do not touch the torch nozzle after welding until it has had time to cool down.

1. Turn Off the power switch when not using the equipment.
2. Turn Off any shielding gases you may have used during the operation of this equipment.
3. Inspect all cords and power cables. Replace any cords or power cables that are damaged or cracked.
4. Disconnect and organize welding cables so they are protected while not in use.

### Maintenance

#### ⚠CAUTION

#### Proper Care, Maintenance, and Repair

- Always have the power disconnected when working on internal components.
- Do not touch or handle the PC board without being properly grounded with a wrist strap. Put the PC board in a static proof bag to move or ship.
- Do not put hands or fingers near moving parts such as the drive rolls of the fan.

#### ⚠WARNING

#### ELECTRIC SHOCK CAN KILL!

- Touching live electrical parts can cause fatal shocks or severe burns. Do not touch live electrical parts.
- Wear dry, hole-free insulating gloves and body protection.

- Disconnect input power before installing, maintaining or servicing this equipment. Lockout/tag out input power according to OSHA 29 CFR 1910.147.

Maintain the product by adopting a program of conscientious repair and maintenance in accordance with the following recommended procedures. It is recommended that the general condition of any tool be examined before it is used. Keep your tool in good repair. Keep all cutting tools sharp and clean. Properly maintained cutting tools with sharp cutting edges are less likely to bind and are easier to control. Keep handles dry, clean, and free from oil and grease. The following chart is based on a normal operation schedule.

Maintenance Interval	Maintenance Point
Before Each Use	Inspect all cords and power cables. Replace any cords or power cables that are damaged or cracked.
Every 3 Months	Inspect all warning and caution labels affixed to this unit. If they are worn, torn or otherwise unreadable, then replace the warning labels.
	Inspect and clean and tighten all weld power connections.
Every 6 months	Unplug the welder and blow out or vacuum the inside.

## Troubleshooting

### ⚠WARNING

#### ELECTRIC SHOCK CAN KILL!

- Touching live electrical parts can cause fatal shocks or severe burns. Do not touch live electrical parts.
- Wear dry, hole-free insulating gloves and body protection.
- Disconnect input power before installing, maintaining or servicing this equipment.
- Lockout/tag out input power according to OSHA 29 CFR 1910.147.

### ⚠CAUTION

Be aware that the Electrode will be electrically HOT when the Input Power Switch on the welder is turned on.

Failure	Possible Cause	Corrective Action
Unit Does Not Power Up.	Unit is not plugged in.	Plug in unit.

<b>Failure</b>	<b>Possible Cause</b>	<b>Corrective Action</b>
	Input power circuit breaker not on.	Reset input power circuit breaker.
	The main power switch is not working.	Replace main power switch.
Protection Indicator Is On.	The internal temperature is too high.	Leave power on and let the fan cool the unit. Output will continue when the unit has cooled.
	Input power voltage is too high or too low.	Meter input power voltage. This unit must be used with input voltage that ranges from 230V AC plus or minus 15%.
	Cooling fan is damaged.	Replace the cooling fan.
Wire Drive Motor Does Not Turn.	Wire feed speed control at zero.	Increase wire feed speed control.
	Trigger is not mashed.	Wire will feed only when trigger is mashed.
	Wire drive motor is damaged.	Replace wire drive motor.
	Feed roller is not correctly installed.	See installation section to correctly install the drive roller.
Wire Feeds Inconsistently.	Torch liner is plugged.	Clear or replace torch liner.
	Wire diameter may vary on spool of wire causing the wire to catch in the contact tip.	Increase the contact tip one size.
	Too much or too little wire tension.	See Installing The Wire section.
	Too much or too little drive roll tension.	See Setting Drive Roll Tension section.
	Drive roll is worn.	Replace drive roll.
Cannot Create An Arc.	Work piece is painted or rusty.	Remove all paint and rust.
	Ground clamp is connected where there is paint or rust.	Remove all paint and rust so ground clamp is connected to bare metal.
	Ground clamp is not electrically connected to the work piece.	Make certain the ground clamp is connected to the work piece.
	Trigger is not mashed.	When in the MIG mode, this unit is not electrically hot until you mash the torch trigger.
	Stick or TIG welding and machine is set for MIG welding.	Make certain the SPOOL GUN/MIG TORCH/STICK WELDING selector switch is in the STICK position.
Welding Arc is Unstable Creating Excessive	The contact tip is too large.	Make certain the correct contact tip is installed.

Failure	Possible Cause	Corrective Action
Spatter.	Torch liner is plugged.	Clear or replace torch liner.
	No shielding gas.	Connect shielding gas supply and turn shielding gas on.
	MIG torch is not correctly installed and shielding gas is not transferring to the arc.	Remove and reconnect the MIG torch to make certain it is completely installed into the MIG connector.
	Wire speed setting is incorrect.	Refer to the label inside the wire compartment door for wire speed setting recommendations.
	Voltage setting is incorrect.	Refer to the label inside the wire compartment door for voltage setting recommendations.
For Assistance, Contact The Welder Help Line at 877-304-0294		

## Parts Diagram

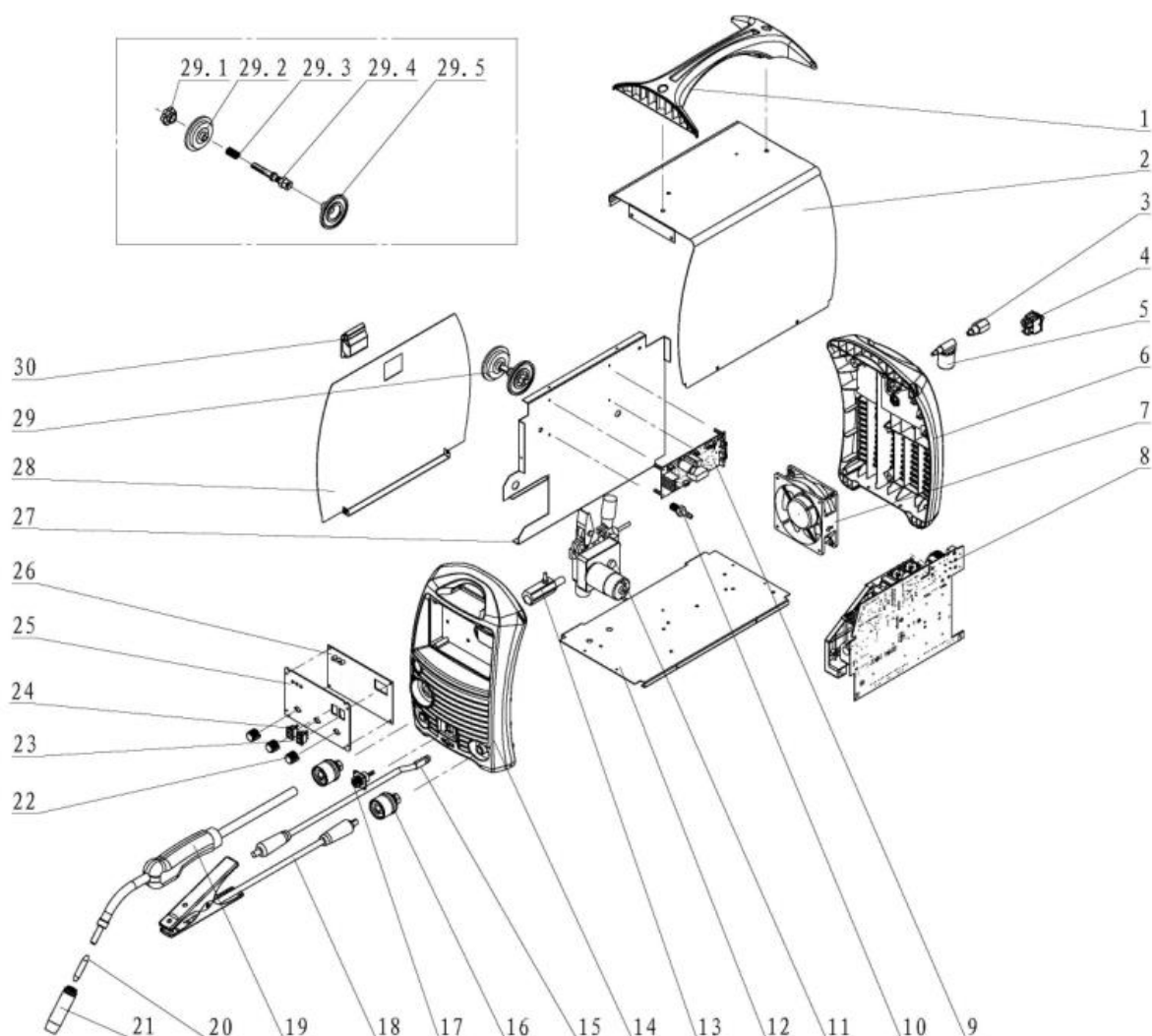

## Parts List

Reference	Part Number	Part Description	Quantity
1	105200044	HANDLE	1
2	125200060	ENCLOSURE	1
**	125400006	WELDER HELP LABEL	1
**	105200041	MIG WARNING LABEL	1
3	105200045	GAS CONNECTOR	1
4	105200050	POWER SWITCH	1
5	105200047	GAS VALVE	1
6	105200048	BACK BEZEL	1
7	105200231	FAN	1
8	105200272	MAIN PC BOARD	1
9	105200273	CONTROL PC BOARD	1
10	105200052	GAS QUICK CONNECT	1
11	105200053	WIRE FEEDER	1
**	105200071	DRIVE ROLL .023V/.030V	1
**	105200072	DRIVE ROLL .030VK/.035V	1
**	105200083	DRIVE ROLL SECUREMENT KNOB	1

Reference	Part Number	Part Description	Quantity
**	105200084	INLET GUIDE	1
**	105200086	QUICK CONNECTOR WITH GAS HOSE	1
12	105200254	BOTTOM	1
13	105200055	MIG CONNECTOR	1
14	105200056	PLASTIC FRONT PANEL BEZEL	1
**	125200060	FRONT PANEL DECAL MP140Si	1
15	105200057	WELD POWER CABLE	1
16	105200058	WELD POWER CONNECTOR	2
17	105200277	TRIGGER RECEPTACLE	1
18	105200060	GROUND CABLE AND CLAMP	1
**	105200069	GROUND CLAMP ONLY	1
19	105200061	MIG TORCH	1
**	105200070	CONTACT TIP ADAPTER	1
20	105200043	CONTACT TIP	1
21	105200062	MIG NOZZLE	1
22	105200063	POTENTIOMETER KNOB	3
23	105200064	SPOT WELD ON/OFF SWITCH	1
24	105200065	WELD GUN SELECTOR SWITCH	1
25	165200066	FRONT PANEL	1
26	105200275	FRONT PANEL PC BOARD	1
27	105200276	MIDDLE BOARD	1
**	105200085	MIG/SPOOLGUN CONNECTION LABEL	1
28	125200061	DOOR	1
**	125200062	SET-UP LABEL MP140Si	1
29	105200009	SPOOL HOLDER	1
29.1	105200010	ADJUSTING NUT	1
29.2	105200012	HOLDER END, LOOSE	1
29.3	105200011	SPRING	1
29.4	105200013	BOLT	1
29.5	105200014	HOLDER END, FIXED	1
30	105200080	LATCH	1
**	125200063	OPERATOR'S MANUAL MP140Si	1
**	105200081	GAS HOSE TO REGULATOR	1
**	105200082	INERT GAS REGULATOR	1
**	105200087	ELECTRODE HOLDER WITH CABLE	1

\*Not Pictured

## Replacement Parts

- For replacement parts and technical questions, please call Customer Service at **1-800-222-5381**.
- Not all product components are available for replacement. The illustrations provided are a convenient reference to the location and position of parts in the assembly sequence.
- When ordering parts, the following information will be required: item description, item model number, item serial number/item lot date code, and the replacement part reference number.
- The distributor reserves the rights to make design changes and improvements to product lines and manuals without notice.

## Limited Warranty

Northern Tool and Equipment Company, Inc. ("We" or "Us") warrants to the original purchaser only ("You" or "Your") that the Klutch product purchased will be free from material defects in both materials and workmanship, normal wear and tear excepted, for a period of **3 years** from date of purchase. The foregoing warranty is valid only if the installation and use of the product is strictly in accordance with product instructions. There are no other warranties, express or implied, including the warranty of merchantability or fitness for a particular purpose. If the product does not comply with this limited warranty, Your sole and exclusive remedy is that We will, at our sole option and within a commercially reasonable time, either replace the product or product component without charge to You or refund the purchase price (less shipping). This limited warranty is not transferable.

### Limitations on the Warranty

This limited warranty does not cover: (a) normal wear and tear; (b) damage through abuse, neglect, misuse, or as a result of any accident or in any other manner; (c) damage from misapplication, overloading, or improper installation; (d) improper maintenance and repair; and (e) product alteration in any manner by anyone other than Us, with the sole exception of alterations made pursuant to product instructions and in a workmanlike manner.

### Obligations of Purchaser

You must retain Your product purchase receipt to verify date of purchase and that You are the original purchaser. To make a warranty claim, contact Us at 1-800-222-5381, identify the product by make and model number, and follow the claim instructions that will be provided. The product and the purchase receipt must be provided to Us in order to process Your warranty claim. Any returned product that is replaced or refunded by Us becomes our property. You will be responsible for return shipping costs or costs related to Your return visit to a retail store.

### Remedy Limits

Product replacement or a refund of the purchase price is Your sole remedy under this limited warranty or any other warranty related to the product. We shall not be liable for: service or labor charges or damage to Your property incurred in removing or replacing the product; any damages, including, without limitation, damages to tangible personal property or personal injury, related to Your improper use, installation, or maintenance of the product or product component; or any indirect, incidental or consequential damages of any kind for any reason.

### Assumption of Risk

You acknowledge and agree that any use of the product for any purpose other than the specified use(s) stated in the product instructions is at Your own risk.

### Governing Law

This limited warranty gives You specific legal rights, and You also may have other rights which vary from state to state. Some states do not allow limitations or exclusions on implied warranties or incidental or consequential damages, so the above limitations may not apply to You. This limited warranty is governed by the laws of the State of Minnesota, without regard to rules pertaining to conflicts of law. The state courts located in Dakota County, Minnesota shall have exclusive jurisdiction for any disputes relating to this warranty.



# **KLUTCH**

Distributed by:

Northern Tool & Equipment Company, Inc.

Burnsville, Minnesota 55306

[www.northerntool.com](http://www.northerntool.com)

Made in China