



30in.Direct Drive Drum Fan

Owner's Manual



⚠ WARNING: Read carefully and understand all ASSEMBLY AND OPERATION INSTRUCTIONS before operating. Failure to follow the safety rules and other basic safety precautions may result in serious personal injury.

Item #6108952

READ & SAVE THESE INSTRUCTIONS

Thank you very much for choosing a Strongway product!

For future reference, please complete the owner's record below:

Serial Number/Lot Date Code (if applicable): _____

Purchase Date: _____

Save the receipt, warranty, and this manual. It is important that you read the entire manual to become familiar with this product before you begin using it.

This product is designed for certain applications only. Northern Tool and Equipment is not responsible for issues arising from modification or improper use of this product such as an application for which it was not designed. We strongly recommend that this product not be modified and/or used for any application other than that for which it was designed.

For technical questions, please call **1-800-222-5381**.

Table of Contents

Intended Use 4

Packaging Contents 4

Technical Specifications 4

Important Safety Information 4

Specific Operation Warnings 6

Grounding 7

Extension Cords 8

Main Parts of Product 9

Assembly Instructions 9

Before Each Use 10

Operating Instructions 10

After Each Use 10

Maintenance 10

Troubleshooting 11

Parts Diagram 12

Parts List 12

Replacement Parts 12

Limited Warranty 13

Intended Use

The Strongway Open Motor Direct Drive Drum Fan is designed to provide high-velocity cooling, ventilation, and circulation in commercial environments. The direct drive feature provides an ultra-quiet operation and prolonged motor life. This fan is ideal for use in warehouses, gyms, and other areas of broad space.

Packaging Contents

- Drum Fan Body (1)
- Wheels Axle (1)
- Wheels (2)
- Cotter Pin (4)
- Owner's Manual (1)
-
-
-

Technical Specifications

Property	Specification
Size	30in.
Motor	120V / 60Hz / 1/3HP
Max Current Consumption	2.2 Amps
CFM	8000

Important Safety Information

⚠️WARNING

- Read and understand all instructions. Failure to follow all instructions may result in serious injury or property damage.
- The warnings, cautions, and instructions in this manual cannot cover all possible conditions or situations that could occur. Exercise common sense and caution when using this tool. Always be aware of the environment and ensure that the tool is used in a safe and responsible manner.
- Do not allow persons to operate or assemble the product until they have read this manual and have developed a thorough understanding of how it works.
- Do not modify this product in any way. Unauthorized modification may impair the function and/or safety and could affect the life of the product. There are specific applications for which the product was designed.
- Use the right tool for the job. DO NOT attempt to force small equipment to do the work of larger industrial equipment. There are certain applications for which this equipment was designed. This product will be safer and do a better job at the capacity for which it was intended. DO NOT use this equipment for a purpose for which it was not intended.
- Industrial or commercial applications must follow OSHA requirements.

⚠️WARNING

PROP 65

- This product can expose you to chemicals including Di(2-ethylhexyl)phthalate (DEHP), which is [are] known to the State of California to cause cancer and birth defects or other reproductive harm.. For more information, go to www.p65warnings.ca.gov.
- Some dust created by power sanding, sawing, grinding, drilling, and other construction activities contains chemicals known to the state of California to cause cancer, birth defects, or other reproductive harm. Some examples of these chemicals are:
 - - lead from lead-based paints,
 - - crystalline silica from bricks and cement and other masonry products, and
 - - arsenic and chromium from chemically-treated lumber.
- Your risk from these exposures varies depending on how often you do this type of work. To reduce your exposure to these chemicals, work in a well-ventilated area, and work with approved safety equipment, such as dust masks that are specially designed to filter out microscopic particles.
- Handling power cords on corded products may expose you to lead, a chemical known to the state of California to cause cancer and birth defects or other reproductive harm. Wash your hands after handling.

⚠️WARNING

WORK AREA SAFETY

- Inspect the work area before each use. Keep work area clean, dry, free of clutter, and well-lit. Cluttered, wet, or dark work areas can result in injury. Using the product in confined work areas may put you dangerously close to cutting tools and rotating parts.
- Do not use the product where there is a risk of causing a fire or an explosion; e.g., in the presence of flammable liquids, gases, or dust. The product can create sparks, which may ignite the flammable liquids, gases, or dust.
- Do not allow the product to come into contact with an electrical source. The tool is not insulated and contact will cause electrical shock.
- Keep children and bystanders away from the work area while operating the tool. Do not allow children to handle the product.
- Be aware of all power lines, electrical circuits, water pipes, and other mechanical hazards in your work area. Some of these hazards may be hidden from your view and may cause personal injury and/or property damage if contacted.

⚠️WARNING

PERSONAL SAFETY

- Stay alert, watch what you are doing, and use common sense when operating the tool. Do not use the tool while you are tired or under the influence of drugs, alcohol, or medication. A moment of inattention while operating the tool may result in serious personal injury.

- Dress properly. Do not wear loose clothing, dangling objects, or jewelry. Keep your hair, clothing and gloves away from moving parts. Loose clothes, jewelry, or long hair can be caught in moving parts. Air vents on the tool often cover moving parts and should be avoided.
- Wear the proper personal protective equipment when necessary. Use ANSI Z87.1 compliant safety goggles (not safety glasses) with side shields, or when needed, a face shield. Use a dust mask in dusty work conditions. Also use non-skid safety shoes, hardhat, gloves, dust collection systems, and hearing protection when appropriate. This applies to all persons in the work area.
- Do not overreach. Keep proper footing and balance at all times.
- Remove keys or wrenches before connecting the tool to an air supply, power supply, or turning on the tool. A wrench or key that is left attached to a rotating part of the tool may cause personal injury.
- Secure the work with clamps or a vise instead of your hand when practical. This safety precaution allows for proper tool operation using both hands.

⚠CAUTION

PRODUCT USE AND CARE

- Do not force the product. Products are safer and do a better job when used in the manner for which they are designed. Plan your work and use the correct product for the job.
- Check for damaged parts before each use. Carefully check that the product will operate properly and perform its intended function. Replace damaged or worn parts immediately. Never operate the product with a damaged part.
- Do not use a product with a malfunctioning switch. Any power tool that cannot be controlled with the power switch is dangerous and must be repaired by an authorized service representative before using.
- Disconnect the power/air supply from the product and place the switch in the locked or off position before making any adjustments, changing accessories, or storing the tool. Such preventive safety measures reduce the risk of starting the tool accidentally.
- Store the product when it is not in use. Store it in a dry, secure place out of the reach of children. Inspect the tool for good working condition prior to storage and before re-use.
- Use only accessories that are recommended by the manufacturer for use with your product. Accessories that may be suitable for one product may create a risk of injury when used with another tool. Never use an accessory that has a lower operating speed or operating pressure than the tool itself.
- Keep guards in place and in working order. Never operate the product without the guards in place.
- Do not leave the tool running unattended.

Specific Operation Warnings

⚠WARNING

- Do not operate any fan with a damaged cord or plug.

- Discard fan or return to an authorized service facility for examination and/or repair.
- Do not run under carpeting.
- Do not cover with throw rugs, runners, or similar coverings.
- Do not route cord under furniture or appliances.
- Arrange cord away from traffic area where it will not be tripped over.
- To reduce the risk of electric shock, do not expose to water/rain or use in damp locations.

Grounding

⚠WARNING

- This machine must be grounded while in use to protect the operator from electrical shock. This unit is equipped with an electrical cord that has an equipment grounding conductor and a grounding plug. The plug **MUST** be plugged into a matching receptacle that is properly installed and grounded in accordance with ALL local codes and ordinances.
- **DO NOT MODIFY THE PROVIDED PLUG.** If it will not fit the receptacle, have the proper receptacle installed by a qualified electrician.
- **CHECK** with a qualified electrician or service person if you do not completely understand the grounding instructions, or if you are not sure the tool is properly grounded.

Grounded Tools: Tools with 3-Prong Plugs

Tools marked with **Grounding Required** have a 3-wire cord and 3-prong grounding plug. The plug must be connected to a properly grounded outlet. If the tool should electrically malfunction or break down, grounding provides a low resistance path to carry electricity away from the user, reducing the risk of electric shock. (See Figure A.)

The grounding prong in the plug is connected through the green wire inside the cord to the grounding system in the tool. The green wire in the cord must be the only wire connected to the tool's grounding system and must never be attached to an electrically live terminal.

Your tool must be plugged into an appropriate outlet, properly installed and grounded in accordance with all codes and ordinances. The plug and outlet should look like those in the following illustration.

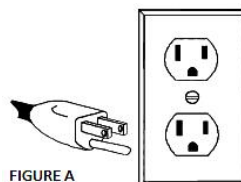

Double Insulated Tools: Tools with Two-Prong Plugs

Tools marked **Double Insulated** do not require grounding. They have a special double insulation system which satisfies OSHA requirements and complies with the applicable standards of Underwriters Laboratories, Inc., the Canadian Standard Association, and the National Electrical Code. (See Figure B.)

Double insulated tools may be used in either of the 120 volt outlets shown in the following illustration.

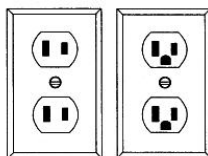

FIGURE B

Extension Cords

⚠WARNING

- **USE A PROPER EXTENSION CORD.** Make sure your extension cord is in good condition. When using an extension cord, be sure to use one heavy enough to carry the current your product will draw. An undersized cord will cause a drop in line voltage, resulting in loss of power and cause overheating.
- Be sure your extension cord is properly wired and in good condition. Always replace a damaged extension cord or have it repaired by a qualified person before using it. Protect your extension cords from sharp objects, excessive heat and damp or wet areas.
- Grounded tools require a 3-wire extension cord. Double Insulated tools can use either a 2- or 3-wire extension cord.
- As the distance from the supply outlet increases, you must use a heavier gauge extension cord. Using extension cords with inadequately sized wire causes a serious drop in voltage, resulting in loss of power and possible tool damage.
- The smaller the wire's gauge number, the greater the capacity of the cord. For example, a 14-gauge cord can carry a higher current than a 16-gauge cord. Minimum extension cord wire size is shown in the following table:

Minimum Wire Size Of Extension Cords				
Nameplate AMPS	Cord Length			
	25'	50'	100'	150'
0-6	18 AWG	16 AWG	16 AWG	14 AWG
6-10	18 AWG	16 AWG	14 AWG	12 AWG
10-12	16 AWG	16 AWG	14 AWG	12 AWG
12-16	14 AWG	12 AWG	NOT RECOMMENDED	

- When using more than one extension cord to make up the total length, make sure each cord contains at least the minimum wire size required.
- If you are using one extension cord for more than one tool, add the nameplate amperes and use the sum to determine the required minimum cord size.
- If you are using an extension cord outdoors, make sure it is marked with the suffix **W-A** (**W** in Canada) to indicate it is acceptable for outdoor use.
- Make sure your extension cord is properly wired and in good electrical condition. Always replace a damaged extension cord or have it repaired by a qualified electrician before using it.
- Protect your extension cords from sharp objects, excessive heat, and damp or wet areas.

Main Parts of **Product**

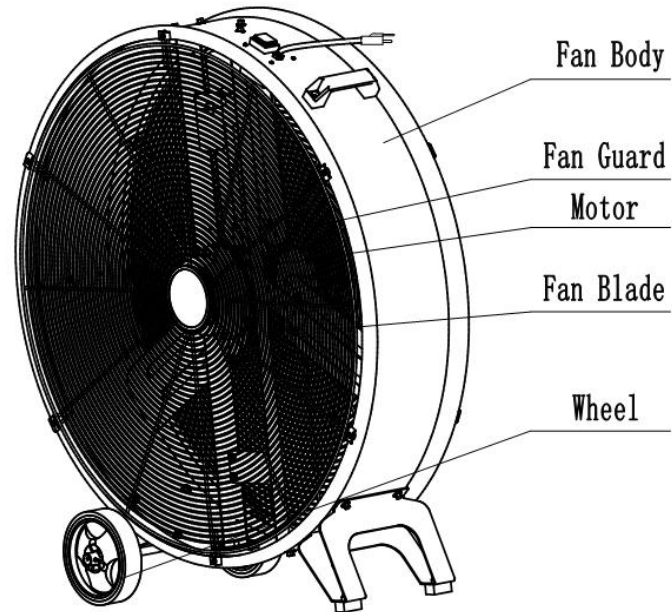

Subassembly

Fan Body
Fan Guard
Motor
Fan Blade
Wheel

Assembly Instructions

⚠WARNING

- Be sure the fan does not have any damage.

1. Slide wheel axle through wheel support frame.
2. Install wheel axle bushing at both ends of the wheel axle.
3. Install wheel onto both ends of the wheel axle.
4. Secure wheel with cotter pin.

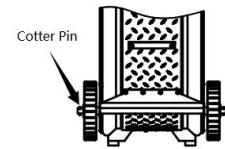
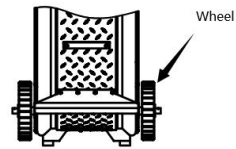
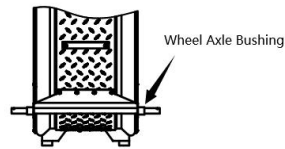
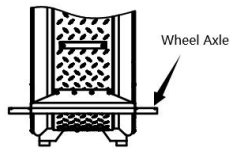

Before Each Use

⚠WARNING

- Before using, be sure the fan does not have any damaged parts.

Locate fan in safe, desired position on level ground, and connect to approved power source.

Operating Instructions

⚠WARNING

- Do not operate any fan with a damaged cord or plug, do not expose to water or rain.

1. Be sure the Power Switch is in the (OFF) position.
2. Connect to an approved power source.
3. Make sure area is clear from all obstructions.
4. Push Power Switch to the LOW position and allow to operate for 10 seconds.
5. Once 10 seconds have passed, you may now push the Power Switch.

After Each Use

⚠WARNING

- Be sure no parts of the fan are damaged.

To turn off the fan, simply return Power Switch to the middle (OFF) position.

Maintenance

⚠WARNING

- Turn power OFF and unplug fan before servicing.

Maintain the product by adopting a program of conscientious repair and maintenance in accordance with the following recommended procedures. It is recommended that the general condition of any tool be examined before it is used. Keep your tool in good repair. Keep all cutting tools sharp and clean. Properly maintained cutting tools with sharp cutting edges are less likely to bind and are easier to control. Keep handles dry, clean, and free from oil and grease. Also refer to the engine manufacturer's instruction manual for additional information about engine maintenance. The following chart is based on a normal operation schedule.

Maintenance Interval	Maintenance Point
Daily before operating	<ol style="list-style-type: none"> 1. Be sure all parts of the fan are secured. 2. Be sure there are no damages to any part of the fan. 3. Be sure the fan is on a level surface.
After 10 operating hours	Turn fan off for 15 minutes to allow motor and fan belt to cool.

Troubleshooting

⚠️WARNING

- Do not operate fan if any part is damaged.

VENDOR: Describe any problems that may occur with the product and how to fix the problems. Use the table below as an example on how to fill in the table. Replace the information in the table (example below) with the information. Add any additional information as needed.

Use the table below to troubleshoot problems before contacting service personnel or your local dealer. If the problem continues after troubleshooting, call your local dealer for assistance.

Failure	Possible Cause	Corrective Action
Fan does not operate	1.No power	Inspect Power Cord for damage. Be sure unit is plugged in and turned on.
	2.Bad Switch	Replace Power Switch(Note:To prolong life of Power Switch,it is recommended that the fan is first operated in LOW for 5-10 seconds before switching to HIGH).
Air Volume Reduction	1.Motor pulley loose	Tighten motor pulley's hex-screw.
Excess Noise(vibration,slapping,squealing)	1.Fan is not on level ground	Turn off fan, move to smooth level surface.
	2.Motor bolts are not secure	Tighten Motor Safeguard bolts and motor bolts.

Parts Diagram

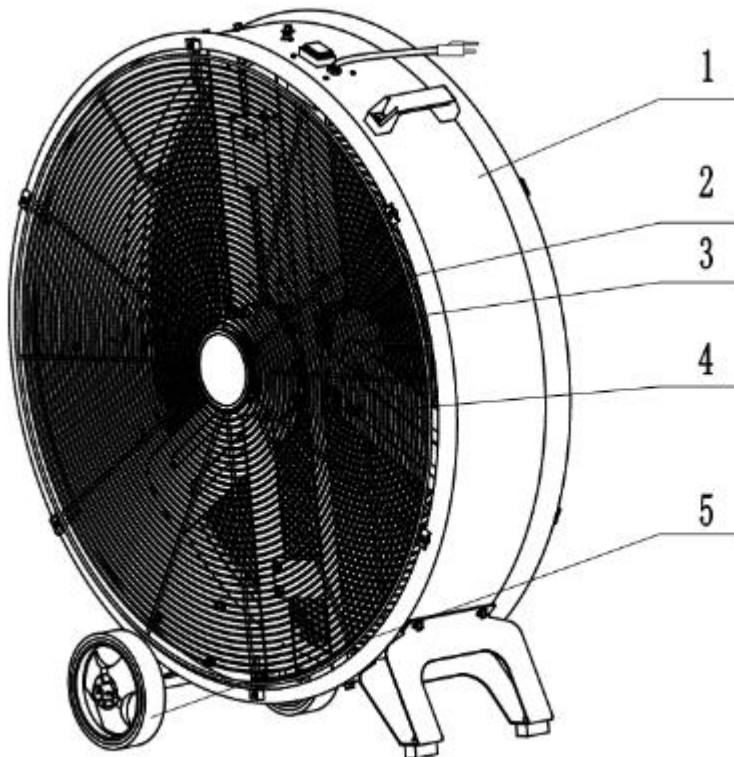

Parts List

VENDOR: List all of the parts that are shown in the exploded diagram.

Part Number	Part Description	Quantity
1	Fan Body	1
2	Fan Guard	2
3	Motor	1
4	Fan Blade	3
5	Wheel	2

Replacement Parts

- For replacement parts and technical questions, please call Customer Service at **1-800-222-5381**.
- Not all product components are available for replacement. The illustrations provided are a convenient reference to the location and position of parts in the assembly sequence.
- When ordering parts, the following information will be required: item description, item model number, item serial number/item lot date code, and the replacement part reference number.
- The distributor reserves the rights to make design changes and improvements to product lines and manuals without notice.

Limited Warranty

Northern Tool and Equipment Company, Inc. ("We" or "Us") warrants to the original purchaser only ("You" or "Your") that the Strongway product purchased will be free from material defects in both materials and workmanship, normal wear and tear excepted, for a period of one year from date of purchase. The foregoing warranty is valid only if the installation and use of the product is strictly in accordance with product instructions. There are no other warranties, express or implied, including the warranty of merchantability or fitness for a particular purpose. If the product does not comply with this limited warranty, Your sole and exclusive remedy is that We will, at our sole option and within a commercially reasonable time, either replace the product or product component without charge to You or refund the purchase price (less shipping). This limited warranty is not transferable.

Limitations on the Warranty

This limited warranty does not cover: (a) normal wear and tear; (b) damage through abuse, neglect, misuse, or as a result of any accident or in any other manner; (c) damage from misapplication, overloading, or improper installation; (d) improper maintenance and repair; and (e) product alteration in any manner by anyone other than Us, with the sole exception of alterations made pursuant to product instructions and in a workmanlike manner.

Obligations of Purchaser

You must retain Your product purchase receipt to verify date of purchase and that You are the original purchaser. To make a warranty claim, contact Us at 1-800-222-5381, identify the product by make and model number, and follow the claim instructions that will be provided. The product and the purchase receipt must be provided to Us in order to process Your warranty claim. Any returned product that is replaced or refunded by Us becomes our property. You will be responsible for return shipping costs or costs related to Your return visit to a retail store.

Remedy Limits

Product replacement or a refund of the purchase price is Your sole remedy under this limited warranty or any other warranty related to the product. We shall not be liable for: service or labor charges or damage to Your property incurred in removing or replacing the product; any damages, including, without limitation, damages to tangible personal property or personal injury, related to Your improper use, installation, or maintenance of the product or product component; or any indirect, incidental or consequential damages of any kind for any reason.

Assumption of Risk

You acknowledge and agree that any use of the product for any purpose other than the specified use(s) stated in the product instructions is at Your own risk.

Governing Law

This limited warranty gives You specific legal rights, and You also may have other rights which vary from state to state. Some states do not allow limitations or exclusions on implied warranties or incidental or consequential damages, so the above limitations may not apply to You. This limited warranty is governed by the laws of the State of Minnesota, without regard to rules pertaining to conflicts of law. The state courts located in Dakota County, Minnesota shall have exclusive jurisdiction for any disputes relating to this warranty.



Distributed by:

Northern Tool & Equipment Company, Inc.

Burnsville, Minnesota 55306

www.northerntool.com

Made in China