

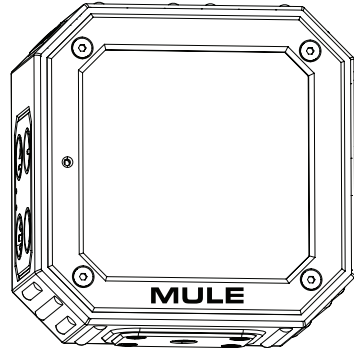

MULE PORTABLE WIRELESS SPEAKER

Model #52015

Owner's Manual



ACCESSORIES



Aux. Cable

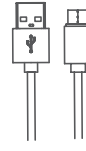

USB-C Cable



Lanyard

CONNECT AND PLAY

PAIR SPEAKER TO DEVICE

After powering up, the blue light flashes rapidly, and the speaker enters the wireless pairing state. Turn on the mobile phone's short-range wireless connection mode and find the name "Mule" and click Connect; The blue light is always on when the connection is successful.

CABLE CONNECTION TO PHONE

Plug the Aux. Cable into the phone and speaker respectively. The blue light flashes slowly when the connection is successful.

CHARGE THE SPEAKER

To charge the speaker, plug the Type-C end of the cable into the speaker while plugging the USB-A end into a USB-A charging port. The blue and red lights stay on after the connection is successful. Type-C audio supports charging while playing.



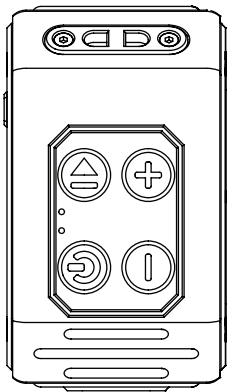

MICRO SD MEMORY CARD (UP TO 64G)

After the memory card is inserted into the speaker, the speaker automatically plays the song in the card, and the blue light flashes slowly at this time. Micro SD cards support APE / FLAC / WMV / WAV / MP3 format playback.

BUTTON FUNCTION



Side of speaker

BUTTON	ACTION	FUNCTION DESCRIPTION
	Tap	Mode Switch
	Press & Hold	Power on/off (1 second/3 seconds) Reset (8 seconds)
	Double Click	Enter/Disconnect from the phone's short range wireless connection.
	Tap	Volume down (there are 16 levels)
	Press & Hold	Previous song (2 seconds)
	Tap	Volume up (there are 16 levels)
	Press & Hold	Next song (2 seconds)
	Tap	Play/Pause during playback. Tap for incoming call. Tap to hang up call.
	Press & Hold	Reject a call (2 seconds)
	Double Click	Redial number.

ATTACH CLAMP TO SPEAKER (OPTIONAL)

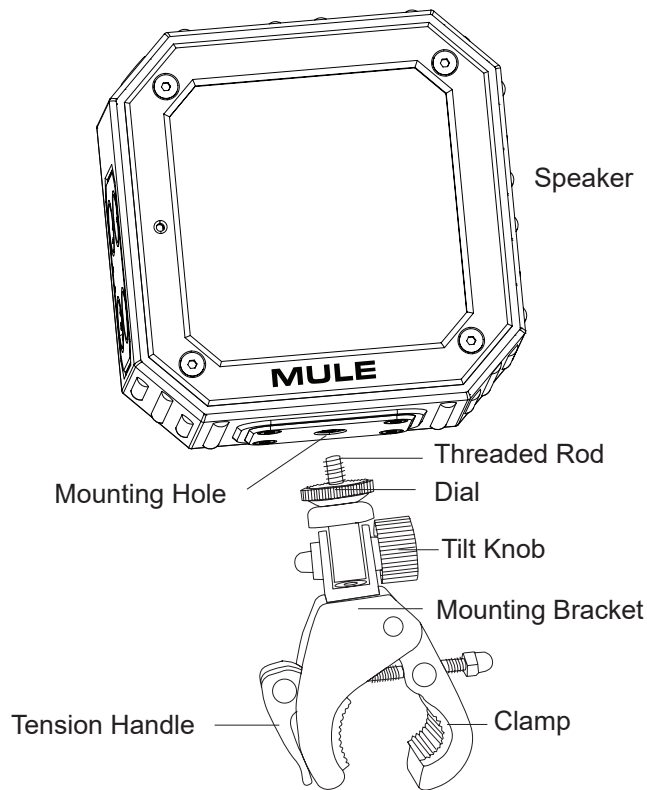

To attach the Mule Portable Wireless Speaker to the mounting bracket, insert the threaded rod into the mounting hole on the underside of the speaker. Turn the speaker clockwise onto the threaded rod at the top of the mounting bracket. Then turn the dial counterclockwise to secure the speaker to the mounting bracket.

The tilt knob can be used to adjust the angle of the speaker. Turn the tilt knob counterclockwise to loosen, adjust the angle of the speaker, and turn the tilt knob clockwise until secure.

The tension handle can be used to tighten the clamp or adjust to the diameter of the tube to which it will attach. Lift the tension handle and turn clockwise to tighten or counterclockwise to loosen the clamp. Then push down the tension handle to lock into place.

SPECIFICATIONS

Item Mule Bluetooth Speaker	Input Power Type C (USB-C) 5V/2A
Bluetooth Version 5.0	F.R. 115Hz~18KHz
Bluetooth Range >18M (open field)	Distortion ≤1%
Speaker 58 mm 15W	Play Time ≥12 hours
Battery 3.7V, 1800 mAh	Charging Time ≤3 hours

SAFETY INFORMATION

- The equipment complies with the standard GB 8898-2011; GB13837-2012; GB17625.1-2012
- Please keep the speaker out of the reach of children to prevent accidents.
- Do not place the speaker in a high temperature environment, including direct sunlight.
- Do not place the speaker near fire sources or other overheated environments.
- Do not place the speaker in a very hot or humid place.
- Do not try to use other methods to charge the speaker other than the charging cable provided.
- Do not disassemble the speaker or attempt to repair or modify it.
- Please avoid drops, impacts, scratches or other behaviors that affect the function of the machine. If there is any damage, such as high temperature deformation or corrosion, please stop using the product and equipment immediately and contact the merchant.
- If the speaker produces abnormal odors, higher than normal temperature, and abnormal changes in color or shape, please stop using the speaker immediately and contact the merchant.
- If the battery is incorrectly replaced, there is a risk of burning. Only the same type or equivalent battery can be used for replacement.
- Using the speaker at high volume for a long time may cause damage to your hearing.
- Do not use any kind of fast charging over 5V-3A, such as PD (USB) fast charging or mobile phone fast charging. The voltage of these charging heads cannot be recognized and are not compatible with the motherboard.
- When the speaker has not been used for more than 3 months, it must be charged before use.
- When not in use for a long time, it is recommended to charge the speaker once every 3 months, which can protect the battery. It is recommended to use the speaker only after it is fully charged.

WARRANTY







The manufacturer warrants all of its speakers against defects in materials and workmanship for one (1) year from the date of purchase. If within this period the product is found to be defective, take a copy of the bill of sale as a proof of purchase and the product in its original carton to the place of purchase. The manufacturer will, at its option, repair, replace or refund the purchase price to the consumer. All costs of installation and removal of the fixture is the responsibility of the consumer. This warranty does not cover speakers becoming defective due to misuse, accidental damage or improper handling and/or installation and specifically excludes liability for direct, incidental or consequential damages. As some states do not allow exclusions of limitations on an implied warranty, the above exclusion and limitation may not apply. This warranty gives you specific rights and you may also have other rights which may vary from state to state.

CUSTOMER SERVICE

To obtain service, please contact Customer Service: 1-(877) 289-8692, 8 a.m. - 5 p.m. Central Time, Monday - Friday.

To order additional Mule products, visit
MULEPRODUCTS.COM. Follow us on social media at:



-  [FACEBOOK.COM/GETTHEMULE](https://www.facebook.com/GETTHEMULE)
-  [YOUTUBE.COM/@GETTHEMULE](https://www.youtube.com/@GETTHEMULE)
-  [TIKTOK.COM/@GETTHEMULE](https://www.tiktok.com/@GETTHEMULE)
-  [INSTAGRAM.COM/GETTHEMULE](https://www.instagram.com/GETTHEMULE)
-  [TWITTER.COM/GETTHEMULE](https://www.twitter.com/GETTHEMULE)
-  [PINTEREST.COM/GETTHEMULE](https://www.pinterest.com/GETTHEMULE)