

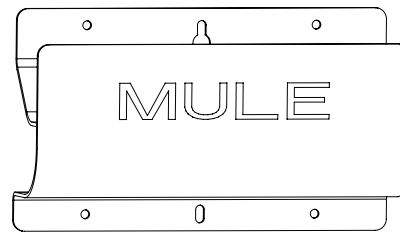

WALL MOUNT BRACKET

Model #52014

Installation Instructions



Screw
Qty. 6



Anchor
Qty. 6

Tools needed: Phillips Screwdriver, Drill, 1/8" or 5/32" Drill Bit, Level, Stud Finder and Pencil



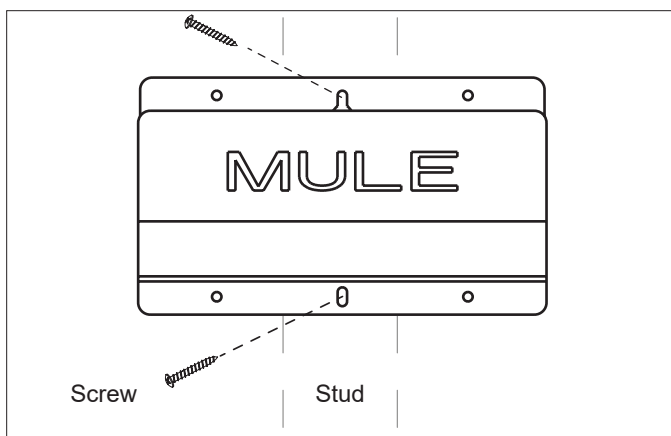



TO MOUNT IN WALL STUD



Use a stud finder to determine the location for the bracket. Mark the location of stud center at the desired installation height. Center the bracket over the stud and mark the top and bottom center holes. **Note:** use a level to ensure bracket is level to the horizon. Drill two 1/8" pilot holes. Then hold the center holes of the bracket over the corresponding pilot holes and use a Phillips head screwdriver to install 2 of the screws from the hardware bag.

To obtain service, please contact Customer Service:
1-(877) 289-8692, 8 a.m. - 5 p.m. Central Time,
Monday - Friday.

To order additional Mule products, visit
MULEPRODUCTS.COM. Follow us on social media at:

-  [FACEBOOK.COM/GETTHEMULE](https://www.facebook.com/GETTHEMULE)
-  [YOUTUBE.COM/@GETTHEMULE](https://www.youtube.com/@GETTHEMULE)
-  [TIKTOK.COM/@GETTHEMULE](https://www.tiktok.com/@GETTHEMULE)
-  [INSTAGRAM.COM/GETTHEMULE](https://www.instagram.com/GETTHEMULE)
-  [TWITTER.COM/GETTHEMULE](https://www.twitter.com/GETTHEMULE)
-  [PINTEREST.COM/GETTHEMULE](https://www.pinterest.com/GETTHEMULE)

TO MOUNT IN DRYWALL

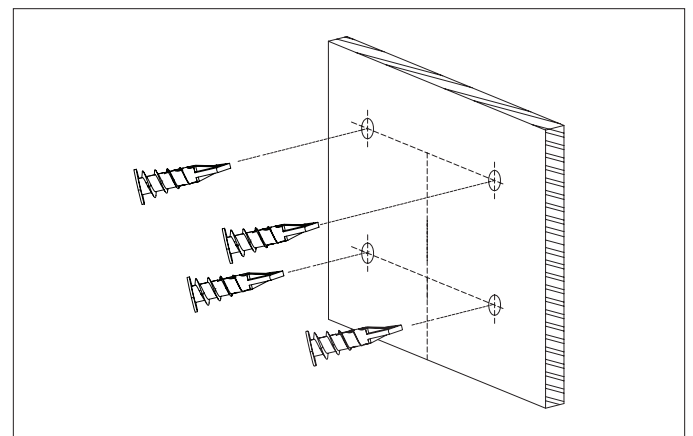

Hold bracket against the wall in desired location and use pencil to mark the location of the four outer holes. **Note:** use a level to ensure bracket is level to the horizon. Remove bracket from wall and drill four 5/32" pilot holes. Use a Phillips screwdriver to install the anchors into pilot holes.

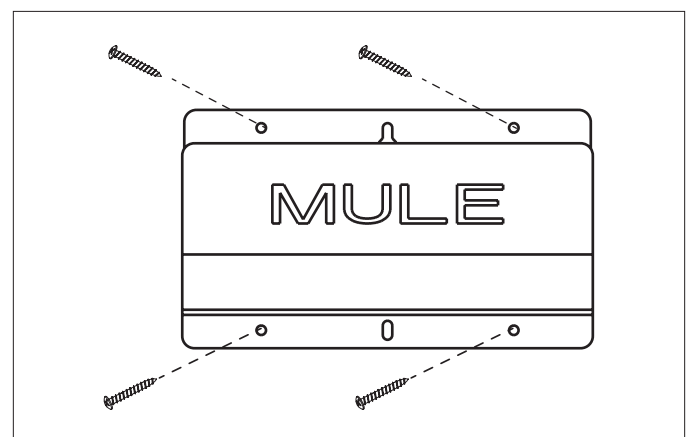

Align the outer holes of the bracket over the corresponding anchors and use a Phillips screwdriver to install the four screws from the hardware bag.