

FLOODGATE

Instructions & Operator Manual



TABLE OF CONTENTS

Product Information.....	Pg. 1
Gate Sizes.....	Pg. 2
Doorway Anatomy.....	Pg. 2
Where to Place the Gate.....	Pg. 3
Fitting Instructions.....	Pg. 4
After-use Maintenance Instructions.....	Pg. 5
Storing your Floodgate.....	Pg. 5
Important Information.....	Pg. 5
Special Situations	
Doorways with No Reveal.....	Pg. 6
Openings too wide for Flood Gates.....	Pg. 7
No Door Frame Fitting Options.....	Pg. 7
Instructions for Stanchion & Side Rails (Optional).....	Pg. 8
Choosing the correct size gates.....	Pg. 8
Preparing the opening.....	Pg. 9
Masonry recessed entrance.....	Pg. 9
Boring the holes for the base.....	Pg. 10
Assembling the Angle Brackets.....	Pg. 11
Preparing the ground surface.....	Pg. 11
Inserting Base assemblies.....	Pg. 12
General Maintenance and installation.....	Pg. 13
Warranty / Usage & Maintenance Log.....	Pg. 14

Product Information

How they work:

Flood Gates have been designed, engineered, and tested to minimize water intrusion, of depths up to 23 inches, through doors or other openings. Flood Gates are not designed to withstand impacts from debris and/or waves. Effectiveness of Flood Gates is dependent upon pressure between sides and bottom of opening. The structure in which it is installed must be in good shape and able to withstand this pressure. Also, the structure surface must have a smooth surface capable of maintaining a seal.

(A) **FLOOD GATE STANDARD** - ADJUSTED FROM REAR OF PRODUCT (Shown without neoprene cover)

MAIN JACKING POINT (HORIZONTAL MOVEMENT OF BARRIER)

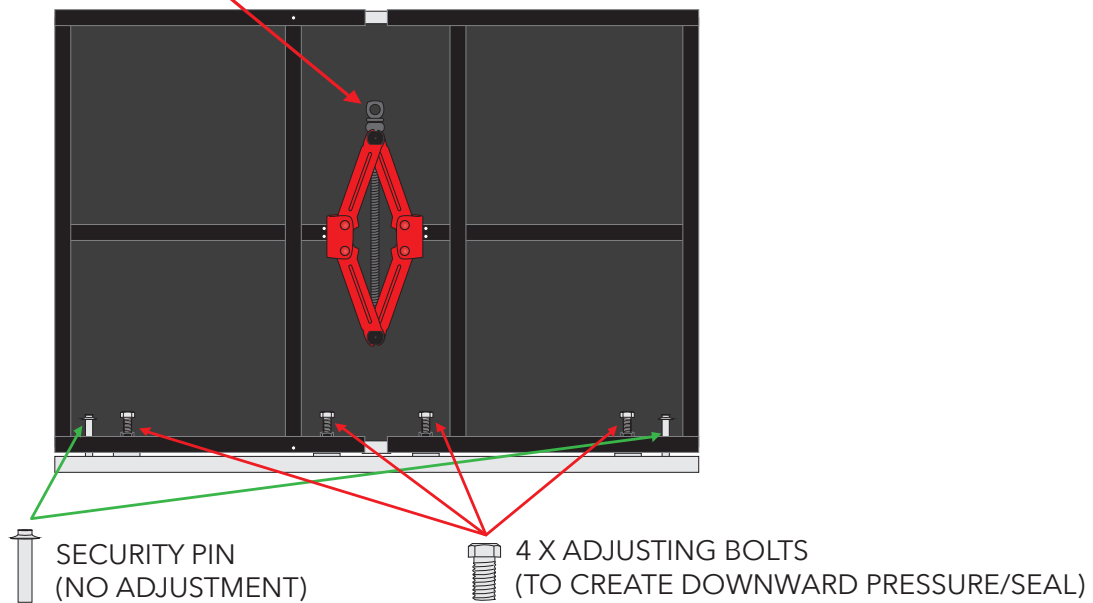

What they are made of:

- A. 1" Steel Tube Frame- provides the support structure
- B. 1/8" Front Steel Flat Sheets- block & take the weight of the water
- C. 2 ton Scissor Jack - expands & creates a secure fit within door frame
- D. Neoprene Sleeve- surrounds entire system & provides a watertight seal around its perimeter

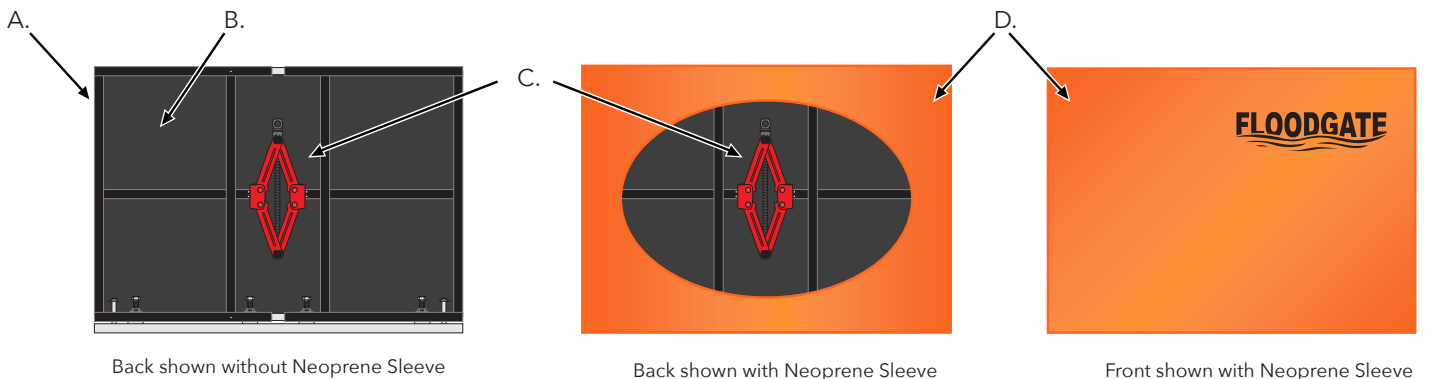

Back shown without Neoprene Sleeve

Back shown with Neoprene Sleeve

Front shown with Neoprene Sleeve

Box components:



Flood Gate



Neoprene Sleeve

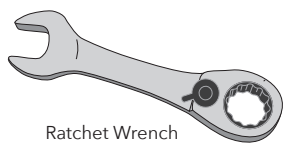

Ratchet Wrench

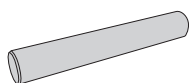

Hand Tool for Scissor Jack

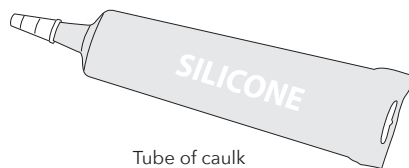

Tube of caulk

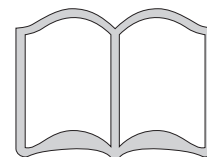

Instructions & Operations Manual

Gate sizes

QDFG30	Fits openings 30" - 35"
QDFG35	Fits openings 35" - 40"
QDFD40	Fits openings 40" - 45"
QDFG45	Fits openings 45" - 50"

Note:

For openings wider than 50", stanchions must be used. See Flood Gate Stanchion Installation & Maintenance section of this manual on page 8.

Doorway anatomy:

- Width of opening** (wall to wall within the reveal)
- Reveal** (measured from the outer side of the door frame, or furthest obstruction outwards, to the corner of the face wall of the building)
- Construction of reveal** (make sure that it is a smooth surface- this will create the most effective seal- if it is not smooth between Flood Gate & reveal use optional side rails.)
- Which way does the door/window open** (inwards, outwards, sash, sliding, up and over, roller shutter, none opening etc.)

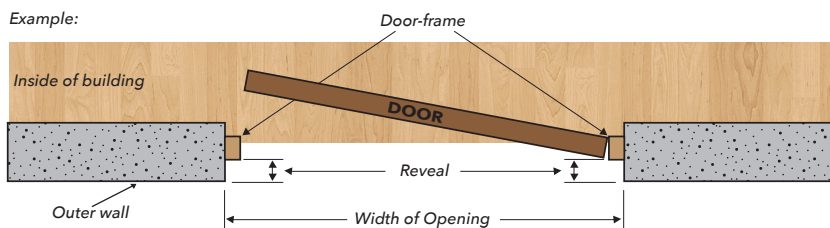

Where to place the gate:

Ideally, the Flood Gate should be placed on the outside of the property, in the reveal. All buildings differ in the amount of reveal available and their surface type; it is recommended that you check your wall and floor surfaces to ensure that water cannot seep under or around the barrier, nor into the plasterwork. Add silicone caulk between Flood Gate and reveal as needed.

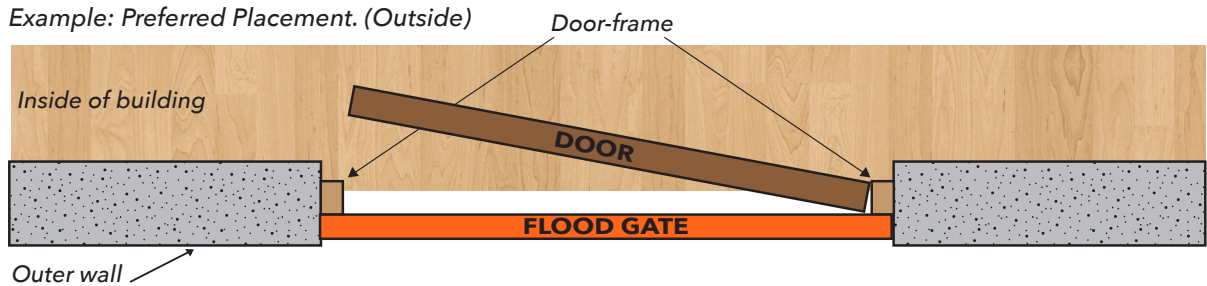

#1 Inward Opening Door (Preferred placement is on outside of property):

Place Flood Gate outside for continued access during flooding.

#2 Outward Opening Door:

Place Flood Gate inside for continued access during flooding.

Requires sufficient reveal for the Floodgate to grip the wall. Ideally, 2" (50 mm) of reveal is recommended, although 1¼" (32 mm) - 1" (25 mm) may be sufficient as long as the Flood Gate can grip tight. This should be measured from the furthest outward point on the door (usually the frame but look for threshold at the bottom of the door that often protrude into the reveal space).

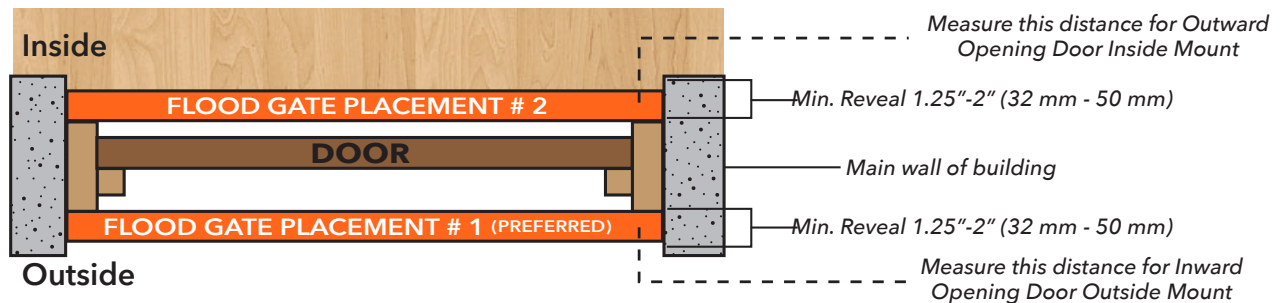

Fitting Instructions

The Flood Gate is designed to seal off doorways from flood water. It can be reused for many years, but must be properly maintained.

The Flood Gate system includes:

1. A metal frame expanding both horizontally and vertically - see Diagram A.
2. A neoprene sleeve - see Diagram B.
3. The rear of the sleeve allows access to the scissor jack and lower bolts - see Diagram C.
4. A hand tool for scissor jack. see Diagram A1
5. A ratchet wrench- see Diagram A2
6. Tube of Silicone Caulk - see Diagram A3.

Installing your Flood Gate

By following the procedures in the correct sequence, the barrier will take approximately 2 minutes to install in position.

STEP ONE

Ensure that your entrance is smooth and clean of dust and debris at the vertical and base area in preparation for positioning. Silicone caulk may be applied to uneven surfaces between wall and Flood Gate.

WARNING - Rough surfaces may damage the sleeve.

STEP TWO

Place the barrier with its face (see Diagram B) toward the flood threat and as close as possible to your entrance in a solid reveal.

WARNING - If you are not sure the reveal can withstand the forces that will be applied to it you MUST seek advice from a structural engineer.

STEP THREE

Keeping the unit in an upright position, apply downward pressure to the unit, while adjusting the horizontal scissor jack - (see Diagrams A & A1).

WARNING - Over extending the unit may weaken it and reduce its effectiveness. It is recommended that expansion be no more than 5 inches (12.7 cm). If a larger unit would fit the opening, it must be used instead of over extending a smaller unit.

STEP FOUR

Adjust each of the 4 downward pressure bolts to a maximum depth of ¼" (7 mm) to compact the sleeve along the ground - (see Diagrams A & A2).

WARNING - DO NOT fully tighten these bolts as this will prevent further adjustment.

STEP FIVE

Silicone caulk may be used, in accordance with the manufacturer's instructions, on the exterior edges of the frame to ensure a complete seal - (see Diagram A3).

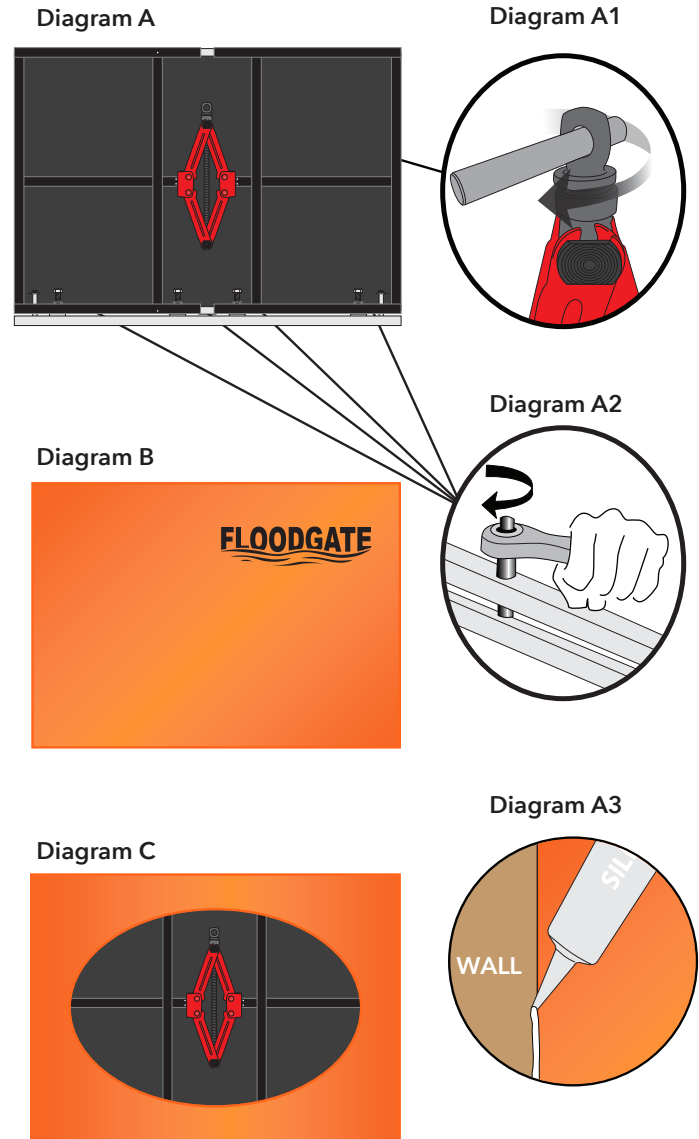

After-use Maintenance Instructions

1. Return the horizontal and vertical operating mechanisms to their closed position.
2. Remove the unit from its position.
3. Remove the sleeve and examine for damage caused by stress, use or wear and tear.
Repair or replace as necessary.
4. The sleeve can be hand washed in warm water up to 104° F (40° C). Rinse in cold water and hang to dry in shaded area. **DO NOT TUMBLE DRY.**
5. Dry off excess moisture from the metal frame. Examine for damage caused by stress, use or wear and tear.
Apply rust proofing oil or grease to all expandable mechanisms.
6. Once all parts of the unit are dry, replace the sleeve over the metal frame so that access can be made to the adjusting mechanisms on the back.

Storing your Flood Gate

1. Store the unit in a secure location and only allow access by a responsible adult.
2. The unit should be stored in its closed and upright position. **DO NOT STORE IN AN EXPANDED STATE.**
3. Store the unit and its accessories in a dry and well ventilated area. **DO NOT STORE IN DIRECT SUNLIGHT.**
4. **DO NOT EXPOSE THE PRODUCT TO EXTREME TEMPERATURES AND KEEP AWAY FROM OPEN FLAMES.**
5. If you are storing more than one unit and do not intend on using the original packaging, the gates must be stored face to face (The face as shown in Diagram B).
6. **DO NOT STORE FACE TO BACK OR BACK TO BACK AT THIS CAN DAMAGE THE PRODUCTS.**
7. Review the unit and its mechanisms periodically to ensure that the conditions of storage have not reduced its effectiveness.

Important information

1. Do not handle the unit in an electrical storm.
2. Do not apply excessive force to any of the adjusting mechanisms of this product.
3. The unit must not be used in extreme temperatures and must be kept away from open flames at all times.
4. Do not apply to the unit, any solvents or other chemicals with which it may react.
5. The unit should only be installed by a responsible adult.
6. Metal finishing on this product can be sharp once the neoprene sleeve has been removed, wear suitable protective gloves when handling metal frame.
7. Ensure that while adjusting the unit, all limbs, loose garments and other personal accessories are kept clear of the moving parts.
8. The unit must not be used if damaged or incomplete.
9. This product is only to be used for the purpose for which it was designed and manufactured.
10. Absorbent Specialty Products (ASP), its associated entities and trading partners, do not accept responsibility for any loss or damage caused by improper use of this product.
11. ASP, its associated entities and trading partners, do not accept responsibility for any loss or damage caused by the ratchet wrench, hand tool or silicone caulk.
12. These products have a finite life and ASP, its associated entities and trading partners, do not accept responsibility for any loss or damage resulting from the deterioration of these products.

Special Situations:

Doorways with no reveal:

Note: If you do NOT have a standard door that fits the Flood Gate, please review the following options to adapt your door frame to accommodate the Flood Gate.

Many doors, particularly PVC doors, patio doors and French windows, are fitted almost flush with the outer face of the building. In these situations, you would need to consider how you can extend the reveal sufficient to allow the barrier to work.

Possible solutions:

SOLUTION # 1 Use a pair of side rails (optional) to fit to either the reveal or the outer face of the building and provide a solid point to which the Floodgates can fit into. (See Example 1.)

Example 1: Side rails (optional accessory).

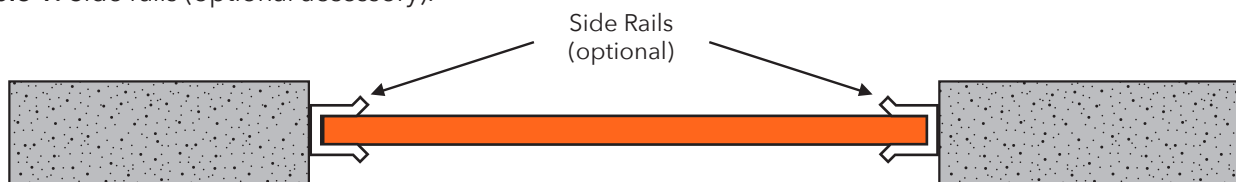

Where Frames & Side Rails are fitted to the wall, the sides and bottom should be sealed with caulk to ensure water cannot bypass the Flood Gate.

SOLUTION # 2 Secure a minimum 2 x 4 pressure treated post flush to exterior wall. Siding may have to be adjusted to ensure a flush mount to wall. Apply silicone caulk between wall and post to ensure water tight seal. Using a tapcon type bolt, ensure sufficient depth to allow Flood Gate to function and post to resist force exerted when installing Flood Gate Barrier. (See Example 2.)

Example 2.

Where the pressure is exerted at 90° to the bolts securing the extra frame, the securing method should be able to resist up to 1½ tons of pressure. Use **Tapcon with Concrete shields** (if necessary) to secure into brick, block, etc.

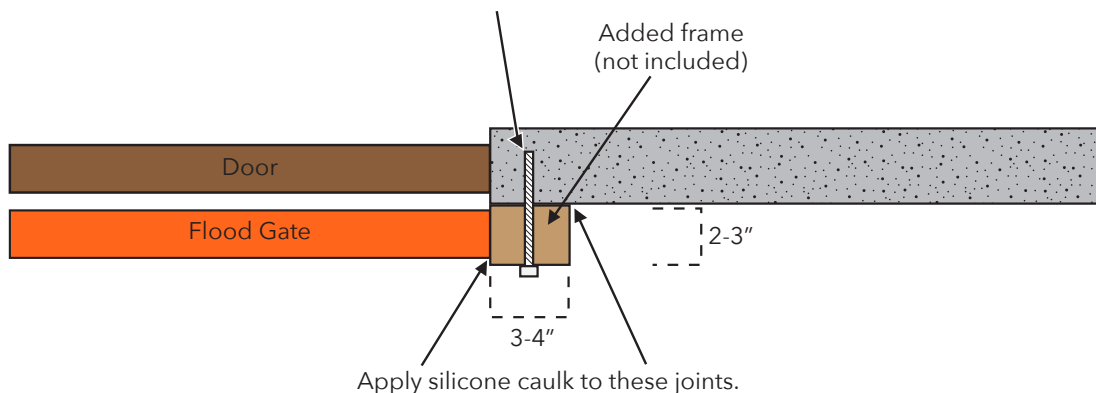

Openings too wide for Flood Gates:

Example 3.

If opening is greater than 50", additional frame may be added to decrease opening size. However, please ensure that the screw heads do **not** protrude from the frame or stanchion and side rails (optional) may be used to connect multiple units together.

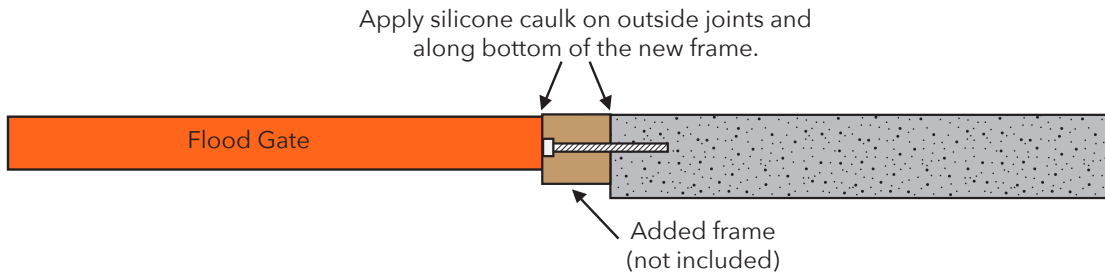

Always ensure the joints between the new frame and the existing wall/frame are 'sealed' with a water resistant silicone caulk to protect against water intrusion.

No door frame options:

To fit the Flood Gate in a wall where the side walls are not adequate, you will need to create a side wall support of some kind. Using optional Side Rails as shown in Examples 1 & 4 or adding additional wood rails (not included). See Example 5

Example 4 (Optional Side Rails):

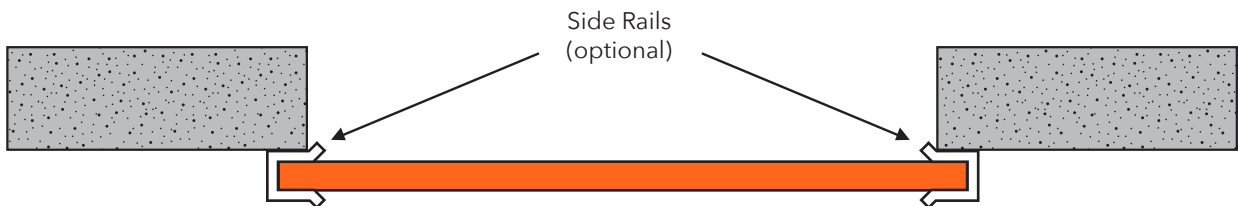

Where Frames & Side Rails are fitted to the wall, the sides and bottom should be sealed with caulk to ensure water cannot bypass the Flood Gate.

Example 5 (Wood rails):

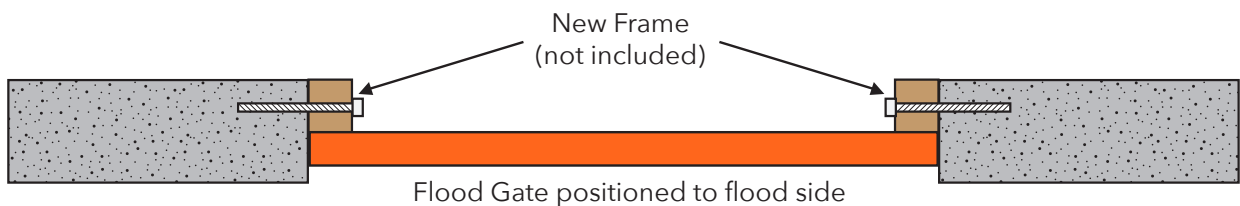

The Frame must be a minimum of 1" (25 mm) deep, to provide sufficient support to the Flood Gate edges. Its width dimension can vary & is not critical. The height of the Frame should match the height of the Flood Gate at 27" (680 mm).

To connect multiple Flood Gates together the stanchion set must be used

Instructions for Stanchion & Side Rails (both optional)

The parts shown in illustrations (A) and (B) come in one kit with all of the necessary hardware. Illustration (C) are the Side Rails & are sold in pairs.

Stanchion & Anchor

- Upright Stanchion (ILL A)
- Base (ILL A)
- Angle Brackets (ILL B)
- Side Rails (optional) (ILL C)

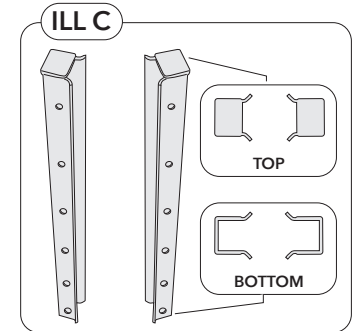
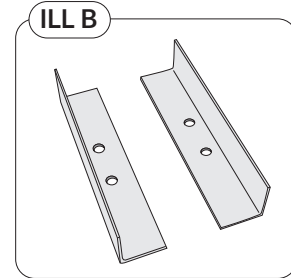
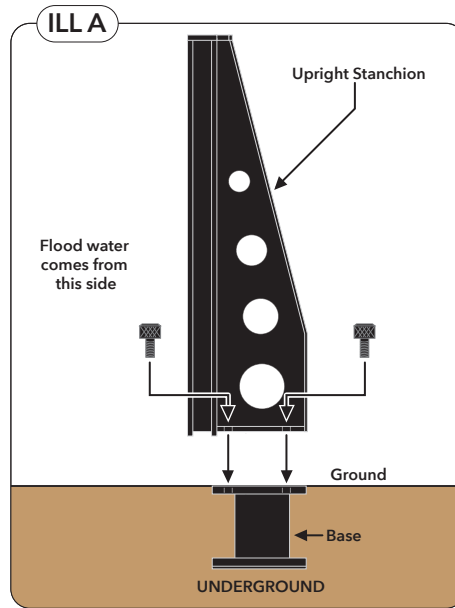

! *The evaluation should be done by a professional engineering consultant.*

Prior to fitting the Flood Gate system to any existing structure or pre-construction, a full evaluation of the structure must be completed to assess whether or not the structure is in fact suitable to withstand the hydro dynamic and hydro static pressures that occur during a flood situation. This includes evaluating the force impact of static water load pressures and moving pressures.

Choosing the correct size Flood Gate:

Determine the appropriate size or mixture of sizes of Flood Gates to fit your openings.

Flood Gate Size 30" - 35"
Max. Expansion: 39"
Height: 26.5"

Flood Gate Size 35" - 40"
Max. Expansion: 44"
Height: 26.5"

Flood Gate Size 40" - 45"
Max. Expansion: 49"
Height: 26.5"

Flood Gate Size 45" - 50"
Max. Expansion: 54"
Height: 26.5"

! The expandable Flood Gate unit should not exceed 5 inches

The decision must be made prior to installing the side rails and preparing the opening.

Once you have measured the opening (D - see ILL D), you must choose a combination of units

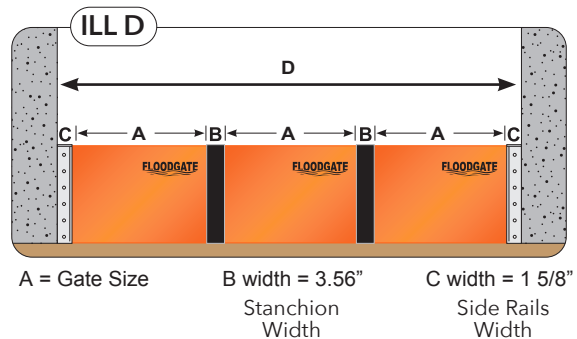

PREPARING THE OPENING

Ensure the planning and evaluation stage is complete and you have identified the products you require and carried out any remedial work that is necessary to square and even wall reveals and ground area. If your frame is not secure or is uneven, then installing side rails (optional) may be necessary.

Installing the Side Rails

Ensure the right and left jam plates are square with the floor at least 30 inches (76 cm) high.

(See illustration E and illustration F).

When the corners are squared, you can install the side rails. (See illustration G and illustration H).



Before you drill and install the side rail screws, you must apply a generous coat of silicone caulk to the full length of each surface of the side rail where it comes in contact with the backing surfaces (e.g. reveal, doorstop, jam plate, brick molding).

If you are fastening against a masonry surface use a carbide tipped 5/32 inch drill bit. Use screws suitable for wood and concrete with shields. If threading into wood you need to drill a 3/32 inch hole first.

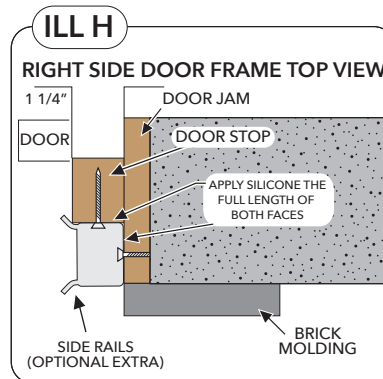
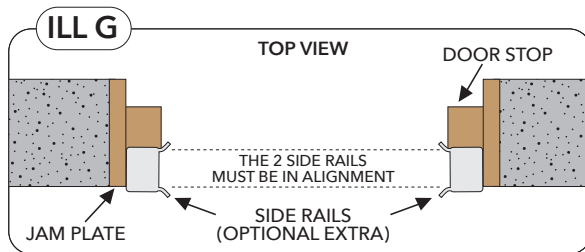
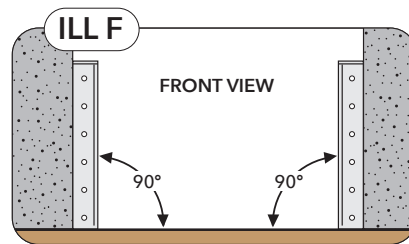
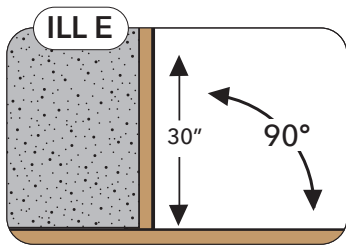

ILL H

When installing the tapered head screws, ensure the heads of the screws are flush or below the top of the counter sink. If the screws are not flush or below they will cut the outer fabric of the Flood Gate and cause a leak.

MASONRY RECESSED ENTRANCE

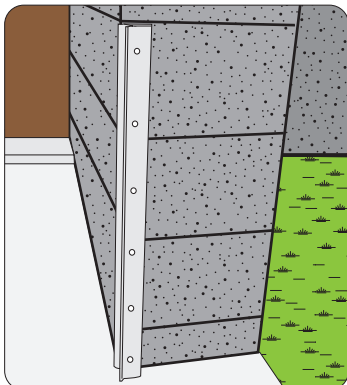

With a recessed entrance the Floodgate System mounts easily. Apply silicone caulk to the side rails which come in contact with the property. Squared to the walkway and wall and screwed into place.

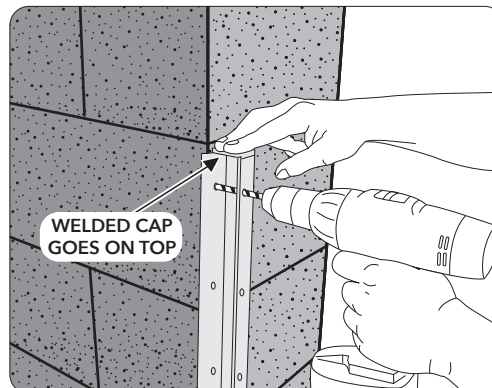

Note the design of the side rails. There is a larger access hole for the drill bit. The cap on top of the side rail prevents the Flood Gate from riding up when tightening the tension bolts on the lower edge of the Flood Gate, thus reducing the amount of horizontal pressure required to secure the Flood Gate in place.

BORING THE HOLES FOR THE BASE

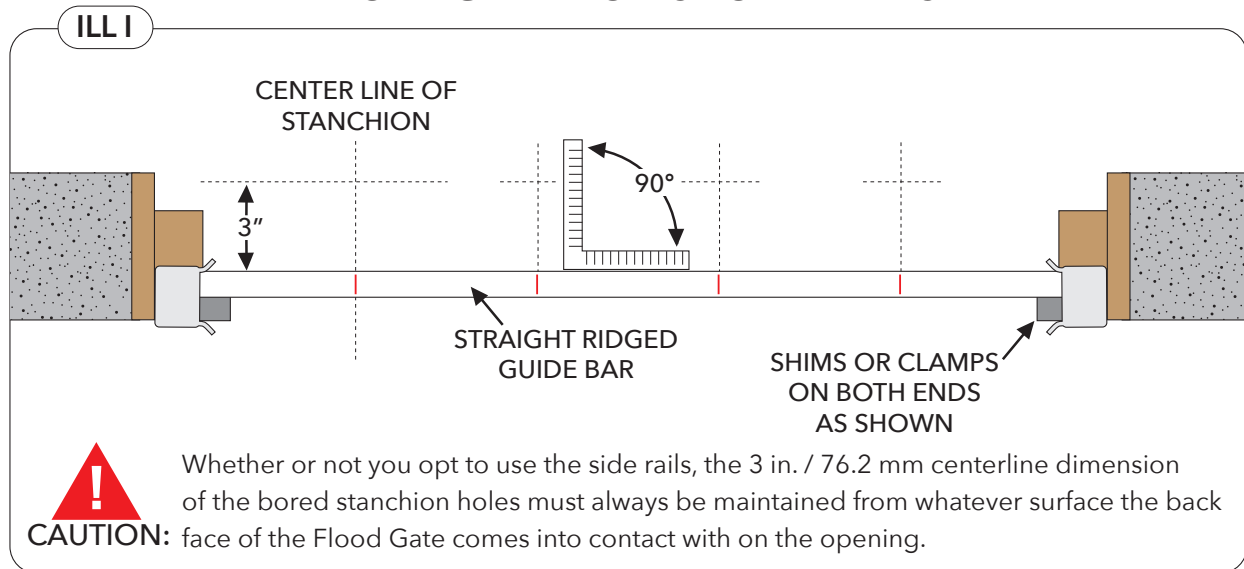

An engineer will advise on the most appropriate method of boring the hole. Two popular methods include (but are not limited to) the use of a high pressure water saw or a diamond faced concrete hole drill.

Use a straight, rigid guide bar (not supplied), cut to the width of the door opening. A guide bar made of $1\frac{1}{4}'' \times 1\frac{1}{4}'' \times \frac{1}{8}''$ (31.75 mm x 31.75 mm x 3.17 mm) angle steel or aluminum is recommended.

Mark a line across the guide bar at appropriate intervals. These marks represent the center line spacing of the holes to be bored. The intervals depend on the mix of Floodgate units you identified at the planning stage as the most suitable.

Lay a carpenter's square on the floor against the inner surface of the guide bar and mark a vertical and horizontal line; this becomes the center of each bored hole.

BORING THE HOLES FOR THE BASE

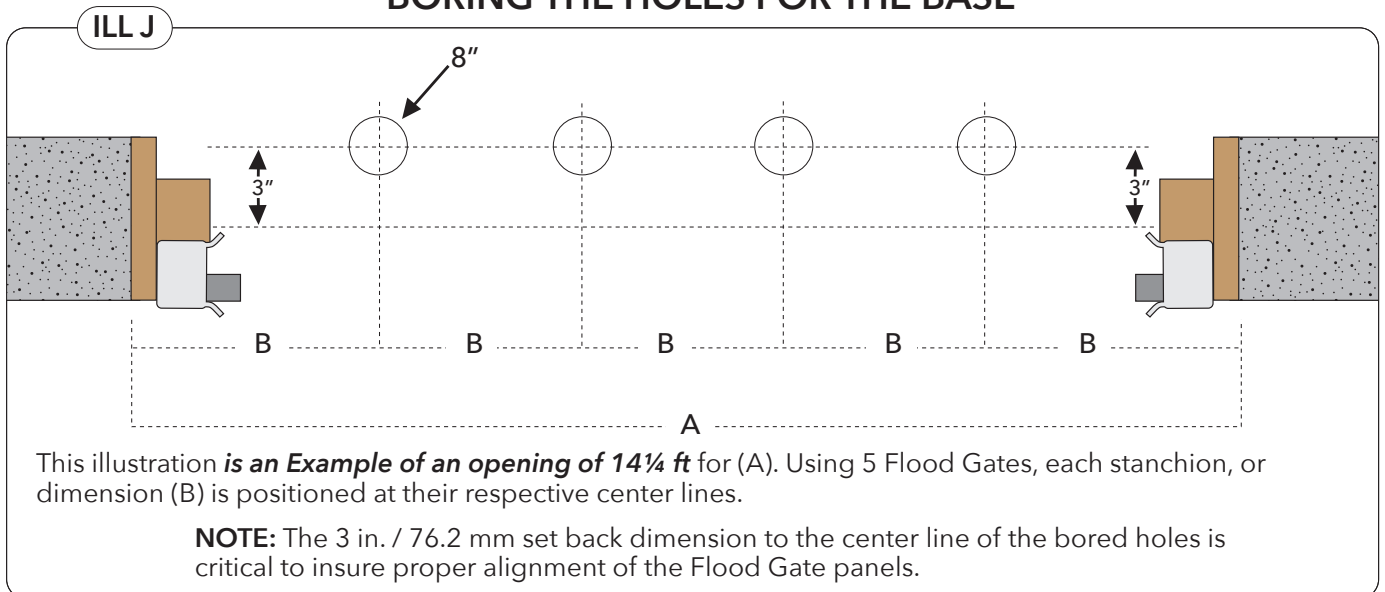

ASSEMBLING THE ANGLE BRACKETS TO BASE

When the holes are bored and cleaned you are ready to set up the base.

1. Assemble the two angle brackets to the base using the four allen head cap screws.

Finger tighten at this point. (See illustration K)

NOTE: The front of the base is where the support rib is located (See illustration N).

2. Using a small square adjust the front angle bracket so it's square to the top side edge of the base. (see illustration K, L and N).

3. While holding the front angle bracket square to the base, tighten all four cap screws.

4. Re-check the front angle bracket again with the square (see illustration L).

5. Firmly clamp or block shim each end of the rigid straight edge into the side rails and against the floor. Ensure that the center line marks (which are put on to the straight edge earlier) are facing upward as these are the marks which you must later line up with the center line marks scribed on to the face of the angle brackets (see illustration I).

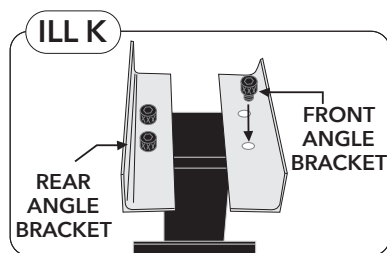

The two angles are the same, but the Front Angle Bracket is the one which is the positioning gauge for each stanchion, therefore it must be squared with the side edge of the base prior to tightening. (See illustration K). The Rear Angle Bracket need not be squared.

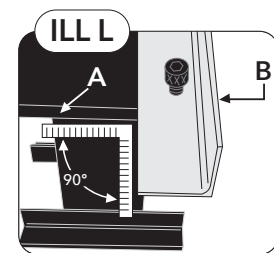

! Face (A) and (B) must be square to each other as shown. A simple 6 in. square works nicely for this.

PREPARING THE GROUND SURFACE AND BASE RECESS

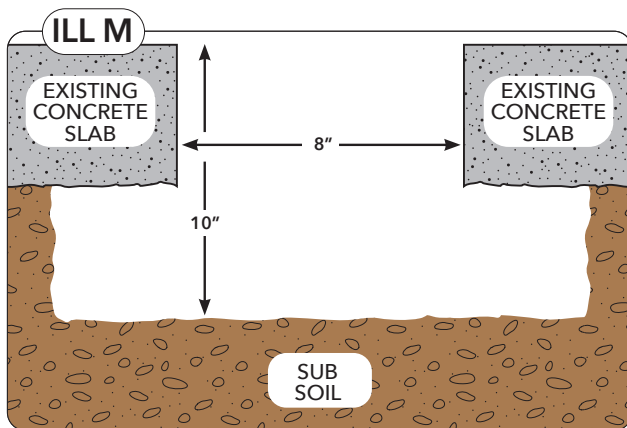

! Concrete floors and slabs vary greatly in terms of thickness and type of concrete. You must create a recess beneath the surface for the anchor which is then set in the concrete foundation. With this style of construction the risk associated with under size floor thickness, cracks and inadequate concrete reinforcement is greatly reduced.

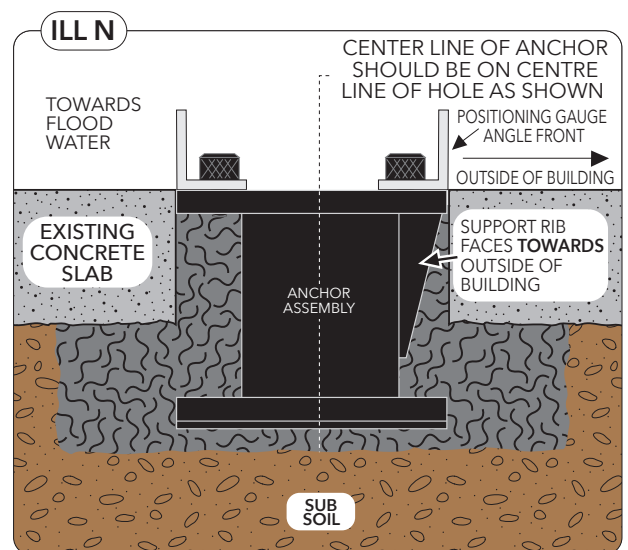

INSERTING BASE ASSEMBLIES

Pour and fill the hole with concrete to a depth of 4 inches from the top and tap or vibrate the concrete to ensure it completely settles at the bottom of the hole. Position the base down into the concrete.

1. Align the center line marks on the angle brackets with the line marks on the center edge. (See illustration P).

 Ensure you clamp the center line marks together so that both angle brackets are resting flat on the surface of the floor. (See illustration N).

NOTE: Each base is designed with a 3" x 3" hollow square tube. At the very top of the tube and through its rear wall, just under the threaded plate, there is a 3/4" hole in the tube. This hole allows air to escape from the inside of the tube while the inside is filling with concrete. (See illustration O)



2. While filling with concrete, gently tap on the very center of the top of the base with a block of wood or handle end of a hammer.

 It is critical that the inside of the base is completely filled with concrete to maintain maximum strength.

3. Ensure the top edge of angle brackets are flush with the surface of the ground.

 Do not remove the clamps and angle brackets for at least 24 to 36 hours depending on the temperature, humidity and soil mechanics to allow concrete to set.

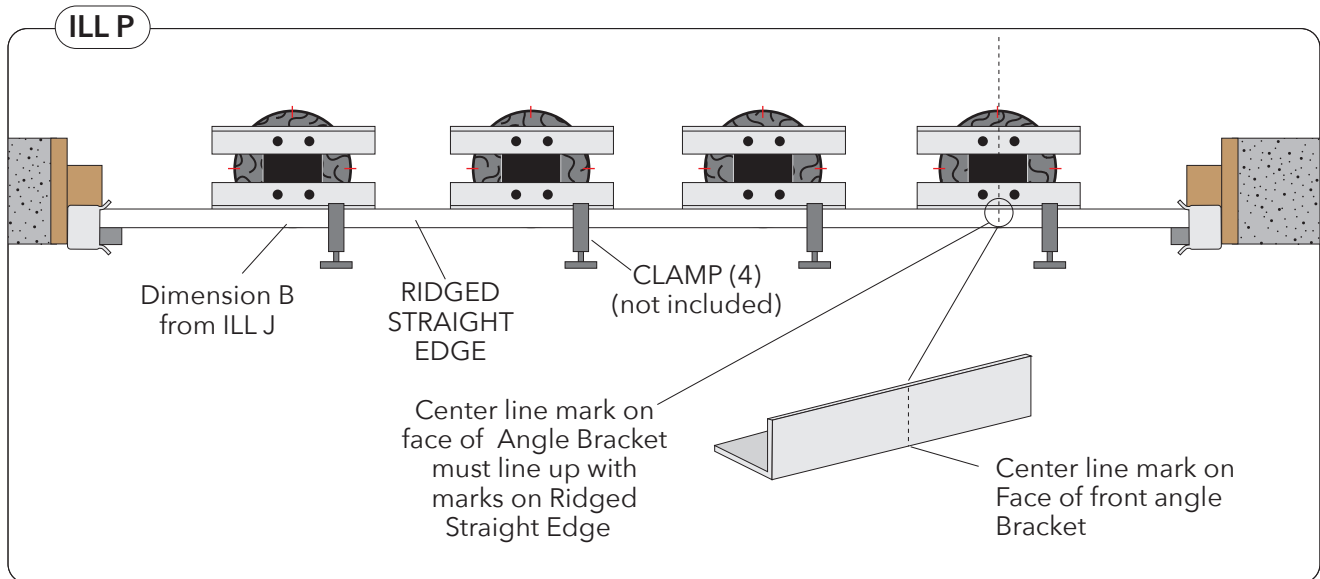



GENERAL MAINTENANCE AND INSTALLATION

Removing the clamp

Keep the Allen Screws and Allen Wrench in a safe place as they will be needed to secure the stanchion to the Base in the event of a flood.

Maintaining the Base

 1. There are (4) 1/2 in. - grub screws with every stanchion. These must be coated with a **waterproof grease or anti-seize compound** and screwed into the holes on each plate. This will protect the threads in the plate and allow traffic to move across the anchor plate without damaging the threads (See illustration Q).

 2. These plugs should be flush with the top of the base and no deeper. They should also be **re-greased periodically and after every use to ensure they will come out when needed**.

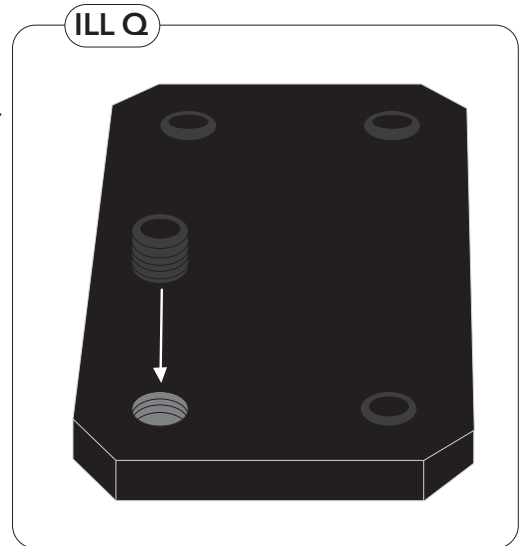

Before installing the stanchion

 To prevent any leaking between the top of the Base and the bottom of the Stanchion there is a machined 3/16" groove which should be **filled with silicone caulk** to add additional sealing (See illustration R).

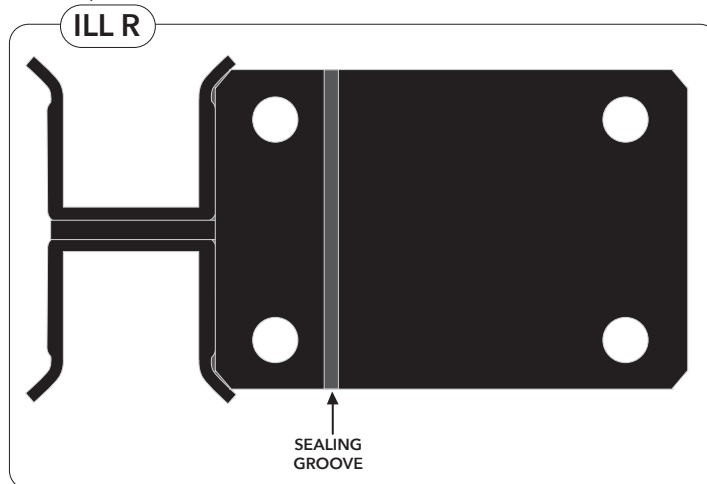

Maintaining the sealing surfaces

 Always keep the top of the Base and the Bottom of the Stanchion clean and free of nicks and dents as these are critical sealing surfaces.

Terms & Conditions

Flood Gate is intended to be used as outlined in this document and other Absorbent Specialty Products (ASP) literature. Data and information provided in this document is for general information purposes only. Conditions for each use of the Flood Gate will vary and are beyond the control of ASP. ASP cannot guarantee desired results. When purchasing this product from ASP, you agree to assume all risks that may arise from ownership, installation, and use of the Flood Gate and agree to release ASP from any and all claims brought by any person or entity against ASP related to and/or arising from your ownership, installation, and/or use of the Flood Gate. ASP shall not be liable for any improper or incorrect ownership, installation or use of this product and assumes no responsibility for anyone's ownership, installation or use of this product. In no event shall ASP be liable for any direct, indirect, incidental, special, exemplary or consequential damages (including, but not limited to: procurement or substitute goods or services; loss of use or profits; or business interruption) however caused and on any theory arising in any way out of the use of this product, even if advised of the possibility of such damage. This disclaimer of liability applies to any damages, injury or death, whether based on alleged breach of contract, tortious behavior, negligence or any other cause of action, including and not limited to damages or injuries caused by any failure of performance, error, omission, defect or delay in operation.

Limited Warranty

ASP warrants this product and components to be free from defects in material and workmanship for a period of one (1) year from date of shipment. If within the term of this warranty, if any Flood Gate component is found to be defective upon inspection by an authorized Flood Gate representative, ASP will replace or repair, at ASP's discretion, any part found to be defective. Unauthorized modification of this product voids this limited warranty. The neoprene sleeve is considered a "wear-item" and is not covered under this warranty. Replacements can be purchased from ASP. Moving parts must be properly maintained prior to storage.

To make a claim under this warranty, contact ASP at this address:

Absorbent Specialty Products
51 Abbot Street
Suite #2
Cumberland, RI 02864
888-761-4405
info@absorbsp.com

Inspection and Maintenance

Usage and Maintenance Log
