

OWNER'S MANUAL

COMMAND 20-25 HP

HORIZONTAL CRANKSHAFT

LP Gas Fueled or Dual-Fueled (LP Gas – Gasoline)



KOHLER
engines

**BORN
TO RUN™**

Safety Precautions

To insure safe operations please read the following statements and understand their meaning. Also refer to your equipment owner's manual for other important safety information. This manual contains safety precautions which are explained below. Please read carefully.

WARNING

Warning is used to indicate the presence of a hazard that *can* cause *severe* personal injury, death, or substantial property damage if the warning is ignored.

CAUTION

Caution is used to indicate the presence of a hazard that *will* or *can* cause *minor* personal injury or property damage if the caution is ignored.

NOTE

Note is used to notify people of installation, operation, or maintenance information that is important but not hazard-related.

For Your Safety!

These precautions should be followed at all times. Failure to follow these precautions could result in injury to yourself and others.



 WARNING

Accidental Starts can cause severe injury or death.
Disconnect and ground spark plug leads before servicing.

Accidental Starts!



Disabling engine. Accidental starting can cause severe injury or death. Before working on the engine or equipment, disable the engine as follows: 1) Disconnect the spark plug lead(s). 2) Disconnect negative (-) battery cable from battery.

Before disconnecting the negative (-) ground cable, make sure all switches are OFF. If ON, a spark will occur at the ground cable terminal which could cause an explosion if hydrogen gas or LP/gasoline fuel vapors are present.

 WARNING

Rotating Parts can cause severe injury.
Stay away while engine is in operation.



Rotating Parts!

Keep hands, feet, hair, and clothing away from all moving parts to prevent injury. Never operate the engine with covers, shrouds, or guards removed.

 WARNING

Hot Parts can cause severe burns.
Do not touch engine while operating or just after stopping.

Hot Parts!

Engine components can get extremely hot from operation. To prevent severe burns, do not touch these areas while the engine is running, or immediately after it is turned off. Never operate the engine with heat shields or guards removed.



 CAUTION

Electrical Shock can cause injury.
Do not touch wires while engine is running.

Electrical Shock!

Never touch electrical wires or components while the engine is running. They can be sources of electrical shock.

California Proposition 65 Warning
Engine exhaust from this product contains chemicals known to the State of California to cause cancer, birth defects, or other reproductive harm.

Safety Precautions (Cont.)

 WARNING

Explosive Fuel can cause fires and severe burns.
Stop engine before filling fuel tank.

Explosive Fuel!



LPG is extremely flammable and is heavier than air and tends to settle in low areas where a spark or flame could ignite the gas. Do not start or operate this engine in a poorly ventilated area where leaking gas could accumulate and endanger the safety of persons in the area.

To insure personal safety, installation and repair of LPG fuel supply systems must be performed only by qualified LPG system technicians. Improperly installed and maintained LPG equipment could cause fuel supply system or other components to malfunction, causing gas leaks.

Observe federal, state and local laws governing LPG fuel, storage, and systems.



– Continued in next column –

Gasoline is extremely flammable and its vapors can explode if ignited. Store gasoline only in approved containers, in well ventilated, unoccupied buildings, away from sparks or flames. Do not fill the fuel tank while the engine is hot or running, since spilled fuel could ignite if it comes in contact with hot parts or sparks from ignition. Do not start the engine near spilled fuel. Never use gasoline as a cleaning agent.

 WARNING

Carbon Monoxide can cause severe nausea, fainting or death.
Do not operate engine in closed or confined area.

Lethal Exhaust Gases!

Engine exhaust gases contain poisonous carbon monoxide. Carbon monoxide is odorless, colorless, and can cause death if inhaled. Avoid inhaling exhaust fumes, and never run the engine in a closed building or confined area.

 WARNING

Explosive Gas can cause fires and severe acid burns.
Charge battery only in a well ventilated area. Keep sources of ignition away.

Explosive Gas!

Batteries produce explosive hydrogen gas while being charged. To prevent a fire or explosion, charge batteries only in well ventilated areas. Keep sparks, open flames, and other sources of ignition away from the battery at all times. Keep batteries out of the reach of children. Remove all jewelry when servicing batteries.

Before disconnecting the negative (-) ground cable, make sure all switches are OFF. If ON, a spark will occur at the ground cable terminal which could cause an explosion if hydrogen gas or LP/gasoline fuel vapors are present.

Congratulations – You have selected a fine four-cycle, twin cylinder, air-cooled engine. Kohler designs long life strength and on-the-job durability into each engine...making a Kohler engine dependable...dependability you can count on. Here are some reasons why:

- Efficient overhead valve design and full pressure lubrication provide maximum power, torque, and reliability under all operating conditions.
- Dependable, maintenance free electronic ignition ensures fast, easy starts time after time.
- Kohler engines are easy to service. All routine service areas (like the dipstick and oil fill, air cleaner, spark plugs, and carburetor) are easily and quickly accessible.
- Parts subject to the most wear and tear (like the cylinder liner* and camshaft) are made from precision formulated cast iron. Because the cylinder liner* can be rebored, these engines can last even longer.

*CH25 engines have POWER-BORE™ Cylinders. These cylinders are plated with nickel-silicon to give increased power, virtually permanent cylinder life, superior oil control, and reduced exhaust emissions. These cylinders cannot be rebored.

- Every Kohler engine is backed by a worldwide network of over 10,000 distributors and dealers. Service support is just a phone call away. Call 1-800-544-2444 (U.S. & Canada) for Sales & Service assistance.

To keep your engine in top operating condition, follow the maintenance procedures in this manual.

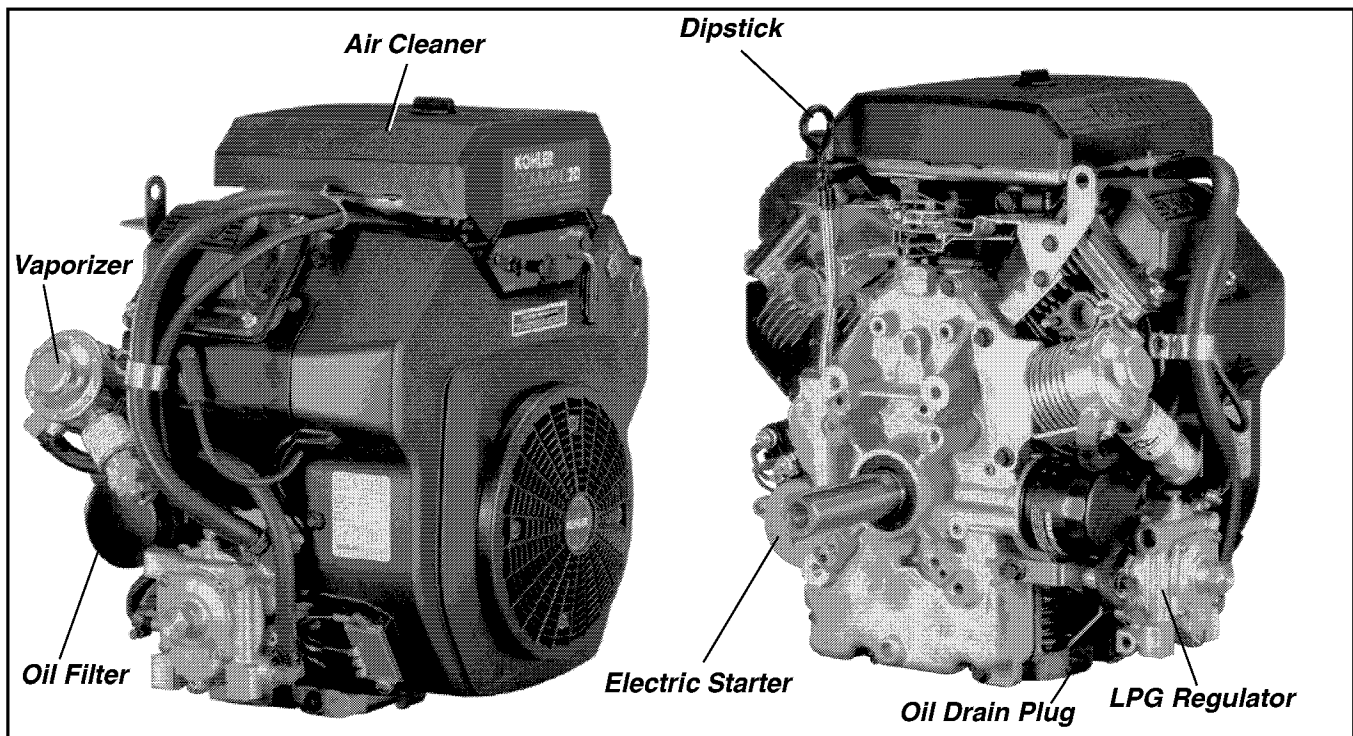

Figure 1. Typical Command Horizontal Shaft LP Gas Fueled Engine.

Oil Recommendations

Using the proper type and weight of oil in the crankcase is extremely important. So is checking oil daily and changing oil regularly. Using oil that is incorrect or dirty can cause premature engine wear and failure.

Synthetic oil is recommended for use in LPG-fueled engines because there is less oxidation or thickening, and deposit accumulation on intake valves is substantially reduced. Conventional petroleum-based oil may be used, but valve service will be required every 500 hours to remove the accumulated deposits. Dual-fueled engines can use conventional oil without requiring special/additional valve service.

Oil Type

Use high quality, oil of **API (American Petroleum Institute) service class SG, SH, SJ or higher**. Select the viscosity based on the air temperature at the time of operation as shown in the following table.

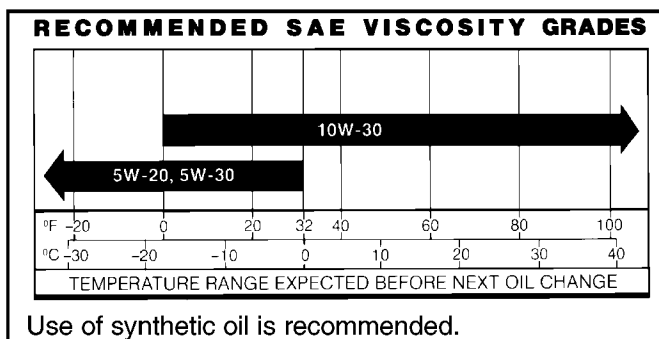

Figure 2. Viscosity Grades Table.

NOTE: Using other than service class SG, SH, SJ or higher oil or extending oil change intervals longer than recommended can cause engine damage.

A logo or symbol on oil containers identifies the API service class and SAE viscosity grade. See Figure 3.

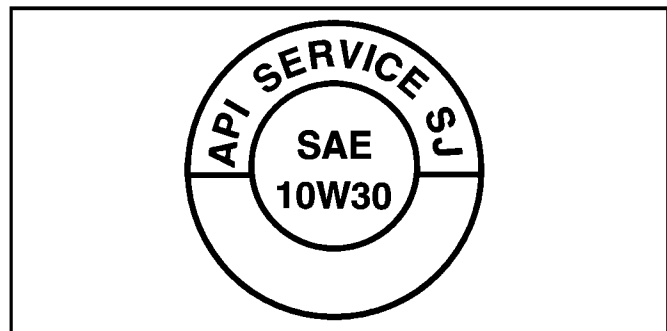

Figure 3. Oil Container Logo.

Refer to "Maintenance Instructions" beginning on page 8 for detailed oil check, oil change, and oil filter change procedures.

LPG Engines

LPG Fuel Recommendations

Liquefied Petroleum Gas (LPG) from an appropriate LP fuel tank (supplied separately) is required to operate this engine.



WARNING: Pressurized LPG!

Fuel tanks are filled under pressure and should be handled with care. To prevent tank damage which could endanger the safety of the operator or persons in the area, do not drop or drag tanks on any surface. Use a hand truck when moving, or tilt the tank on its footing in a position slightly off vertical and roll it.

Avoid personal contact with LPG fuel to prevent frostbite. See a physician if frostbite occurs.



WARNING: Explosive Fuel!

LPG is extremely flammable, is heavier than air and tends to settle in low areas where a spark or flame could ignite the gas. Do not start or operate this engine in a poorly ventilated area where leaking gas could accumulate and endanger the safety of persons in the area.

LPG fuel consists primarily of propane, although the fuel supplier may sometimes mix other gases with propane.

Fuel tanks must be filled only by persons qualified in the handling of LPG. Tanks are filled by weight and should not be overfilled (never to more than 80 percent of total capacity). An air space must be present in the tank to allow fuel to expand.

Tanks must be removed from equipment before filling.

Dual-Fuel Engines

Dual-fuel engines are designed to operate on either LPG or gasoline. For LPG operation, the above information and warnings apply. For gasoline operation, the following information and warnings apply.

Fuel Recommendations



WARNING: Explosive Fuel!

Gasoline is extremely flammable and its vapors can explode if ignited. Store gasoline only in approved containers, in well ventilated, unoccupied buildings, away from sparks or flames. Do not fill the fuel tank while the engine is hot or running, since spilled fuel could ignite if it comes in contact with hot parts or sparks from ignition. Do not start the engine near spilled fuel. Never use gasoline as a cleaning agent.

General Recommendations

Purchase gasoline in small quantities and store in clean, approved containers. A container with a capacity of 2 gallons or less with a pouring spout is recommended. Such a container is easier to handle and helps eliminate spillage during refueling.

Do not use gasoline left over from previous season, to minimize gum deposits in your fuel system and to insure easy starting.

Do not add oil to the gasoline.

Do not overfill the fuel tank. Leave room for the fuel to expand.

Fuel Type

For best results, use only clean, fresh, **unleaded** gasoline with a pump sticker octane rating of 87 or higher. In countries using the Research method, it should be 90 octane minimum.

Unleaded gasoline is recommended as it leaves less combustion chamber deposits. Leaded gasoline may be used in areas where unleaded is not available and exhaust emissions are not regulated. Be aware however, that the cylinder heads may require more frequent service.

Gasoline/Alcohol blends

Gasohol (up to 10% ethyl alcohol, 90% unleaded gasoline by volume) is approved as a fuel for Kohler engines. Other gasoline/alcohol blends are not approved.

Gasoline/Ether blends

Methyl Tertiary Butyl Ether (MTBE) and unleaded gasoline blends (up to a maximum of 15% MTBE by volume) are approved as a fuel for Kohler engines. Other gasoline/ether blends are not approved.

Model Designation

Model CH20S for example: C designates Command engine, H designates horizontal crankshaft, and 20 designates horsepower. A letter suffix designates a specific version as follows:

Suffix	Designates
S	Electric Start

Engine Identification Numbers

When ordering parts, or in any communication involving an engine, always give the **Model, Specification, and Serial Numbers** of the engine.

The engine identification numbers appear on a decal affixed to the engine shrouding. Include letter suffixes, if there are any.

Record your engine identification numbers on the identification label below (Figure 4) for future reference.



Figure 4. Engine Identification Label.

The Emission Compliance Period referred to on the Emission Control or Air Index label indicates the number of operating hours for which the engine has been shown to meet CARB emission requirements. The following table provides the Engine Compliance Period (in hours) associated with the category descriptor found on the certification label.

Emission Compliance Period (Hours)

CARB	Moderate 125 hours	Intermediate 250 hours	Extended 500 hours
------	-----------------------	---------------------------	-----------------------

Refer to certification label for engine displacement.

Exhaust Emission Control System for models CH20 LP, CH25 LP, and CH25 Dual Fuel (open loop), is EM. Exhaust Emission Control System for model CH25 Dual Fuel (closed loop) is EM, O2S, ECM.

Operating Instructions

Also read the operating instructions of the equipment this engine powers.

Pre-Start Checklist

- Check oil level. Add oil if low. Do not overfill.
- Check fuel gauge on LPG tank. Tanks should be filled to a specific weight. To insure safety and proper fuel system operation, tanks must not be overfilled.
- Check fuel lines, regulator, and other system components for leaks. Do not start engine until leaks are eliminated.
- Check cooling air intake areas and external surfaces of engine. Make sure they are clean and unobstructed.
- Check that the air cleaner components and all shrouds, equipment covers, and guards are in place and securely fastened.
- Check that any clutches or transmissions are disengaged or placed in neutral. This is especially important on equipment with hydrostatic drive. The shift lever must be exactly in neutral to prevent resistance which could keep the engine from starting.



WARNING: Lethal Exhaust Gases!

Engine exhaust gases contain poisonous carbon monoxide. Carbon monoxide is odorless, colorless, and can cause death if inhaled. Avoid inhaling exhaust fumes, and never run the engine in a closed building or confined area.

Although LPG burns more efficiently and emits less carbon monoxide than gasoline, some carbon monoxide is produced. Avoid inhaling exhaust gases, especially over prolonged periods of time. Do not allow engine to run unattended.

Cold Weather Starting Hints

1. Be sure to use the proper oil for the temperature expected. See Figure 2 on page 4.
2. Disengage all possible external loads.
3. Be sure the battery is in good condition. A warm battery has much more starting capacity than a cold battery.

Starting

1. Place the throttle control *in* the **idle** position. Place the choke control into the “**on**” position. See Figure 5. On dual-fueled engines, place the three-position fuel control switch in the **gasoline** position and place the throttle control between half and full throttle (engine **must** be started and run on gasoline for 1 minute to heat up oxygen sensor).



Figure 5. Optional Engine Mounted Throttle and Choke Controls.

2. Slowly turn the fuel valve on the LPG (propane) tank to full open position. For “gasoline only” operation on dual-fuel units, leave valve closed.
3. Start the engine by activating the key switch. Release the switch as soon as the engine starts. Return choke to “**off**” position after engine starts. On a cold engine, it may be necessary to leave choke partially on until engine begins to warm up. Dual-fuel engines must be allowed to warm up on gasoline for at least 1 minute. To switch to LPG operation, move the three-position switch to the LPG position.

NOTE: Do not crank the engine continuously for more than 10 seconds at a time. If the engine does not start, allow a 60 second cool down period between starting attempts. Failure to follow these guidelines can burn out the starter motor.

NOTE: If the engine develops sufficient speed to disengage the starter but does not keep running (a false start), engine rotation must be allowed to come to a complete stop before attempting to restart the engine. If the starter is engaged while the flywheel is rotating, the starter pinion and flywheel ring gear may clash, resulting in damage to the starter.

If the starter does not turn the engine over, shut off starter immediately. Do not make further attempts to start the engine until the condition is corrected. Do not jump start using another battery (refer to “Battery” on page 8). See your Kohler Engine Service Dealer for trouble analysis.

NOTE: Upon start-up, a metallic ticking may occur. This is caused by hydraulic lifter leakdown during storage. Run the engine for 5 minutes. The noise will normally cease in the first minute. If noise continues, run the engine at mid-throttle for 20 minutes. If noise persists, take the engine to your local Kohler Service outlet.

Stopping

LPG-Only Engines

1. Turn fuel valve on LPG tank to full closed position and allow the engine to continue running until it runs out of fuel. Turn ignition switch to “**off**” position.

Dual-Fuel Engines

1. Dual-fuel engines may be stopped any of three ways:
 - a. When operating on LPG, one method is the same as described above for LPG-only engines.
 - b. LPG operation can also be stopped by moving the three-position fuel control switch to the “**off**” position and letting the engine run out of fuel. Turn off ignition switch. If engine will not be restarted for some time, also close fuel valve at LPG tank.
 - c. To stop the engine from gasoline operation, it should be running between half and full throttle. Move the three-position fuel control switch and/or the ignition switch to the “**off**” position.

In an **emergency**, move the throttle control to **stop** or turn the ignition switch off.

NOTE: Backfiring may occur when using the emergency stop method!

Battery

A 12 volt battery is normally used. Refer to the operating instructions of the equipment this engine powers for specific battery requirements.

If the battery charge is not sufficient to crank the engine, recharge the battery (see page 12).

Operating

Angle of Operation

This engine will operate continuously at angles up to 25°. Check oil level to assure crankcase oil level is at the "F" mark on the dipstick.

Refer to the operating instructions of the equipment this engine powers. Because of equipment design or application, there may be more stringent restrictions regarding the angle of operation.

NOTE: Do not operate this engine continuously at angles exceeding 25° in any direction. Engine damage could result from insufficient lubrication.

Cooling

NOTE: If debris builds up on the flywheel screen or other cooling areas, stop the engine immediately and clean. Operating the engine with blocked or dirty air intake and cooling areas can cause extensive damage due to overheating.



WARNING: Hot Parts!

Engine components can get extremely hot from operation. To prevent severe burns, do not touch these areas while the engine is running, or immediately after it is turned off. Never operate the engine with heat shields or guards removed.

Engine Speed

NOTE: Do not tamper with the governor setting to increase the maximum engine speed. Overspeed is hazardous and will void the engine warranty. The maximum allowable high speed for these engines is 3750 RPM, no load.

Maintenance Instructions

Maintenance, repair, or replacement of the emission control devices and systems, which are being done at the customers expense, may be performed by any* non-road engine repair establishment or individual. Warranty repairs must be performed by an authorized Kohler service outlet.

*For safety and health reasons, many states require special licensing or certification for servicing LPG fuel systems. Check local and state regulations before choosing a repair establishment to perform fuel system repairs.



WARNING: Accidental Starts!

Disabling engine. Accidental starting can cause severe injury or death. Before working on the engine or equipment, disable the engine as follows: 1) Disconnect the spark plug lead(s). 2) Disconnect negative (-) negative (-) battery cable from battery.

Before disconnecting the negative (-) ground cable, make sure all switches are off. If on, a spark will occur at the ground cable terminal which could cause an explosion if hydrogen gas or LP/gasoline fuel vapors are present.

Maintenance Schedule

These required maintenance procedures should be performed at the frequency stated in the table. They should also be included as part of any seasonal tune-up.

Frequency	Maintenance Required
Daily or Before Starting Engine	<ul style="list-style-type: none"> • Check fuel gauge on propane (LPG) tank. Fill gasoline tank (dual-fuel units only). • Check oil level. • Check air cleaner for dirty¹, loose, or damaged parts. • Check air intake and cooling areas, clean as necessary¹.
Every 25 Hours	<ul style="list-style-type: none"> • Service precleaner element¹.
Every 100 Hours	<ul style="list-style-type: none"> • Replace air cleaner element¹. • Change oil. • Remove cooling shrouds and clean cooling areas¹. • Check oil cooler fins, clean as necessary (if equipped). • Check spark plug condition and gap.
Every 200 Hours	<ul style="list-style-type: none"> • Change oil filter.
Annually or Every 300 Hours	<ul style="list-style-type: none"> • Replace spark plugs.
Annually or Every 500 Hours	<ul style="list-style-type: none"> • Check all lines (high pressure/vacuum) including fittings for leaks. • Have electric starter serviced². • Have lock-off/filter serviced³. • Have combustion deposits removed if using non-synthetic oil (not on dual-fuel engines). • Drain regulator of accumulated fuel deposits (Nikki regulators only).
Every 1500 Hours	<ul style="list-style-type: none"> • Have regulator disassembled, cleaned, and reset³.

¹Perform these maintenance procedures more frequently under extremely dusty, dirty conditions.

²Have a Kohler Engine Service Dealer perform this service.

³Must be performed by an Authorized Kohler Engine Dealer or qualified LP personnel **only**.

Check Oil Level

The importance of checking and maintaining the proper oil level in the crankcase cannot be overemphasized. Check oil **BEFORE EACH USE** as follows:

1. Make sure the engine is stopped, level, and is cool so the oil has had time to drain into the sump.
2. To keep dirt, debris, etc., out of the engine, clean the area around the dipstick before removing it.
3. Remove the dipstick; wipe oil off. Reinsert the dipstick into the tube and press all the way down.
4. Remove the dipstick and check the oil level.

The oil level should be up to, but not over, the "F" mark on the dipstick. See Figure 6.

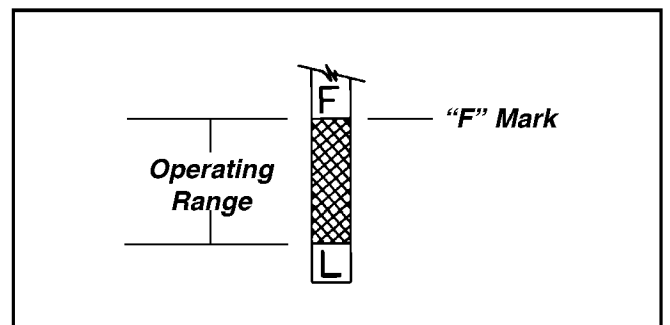

Figure 6. Oil Level Dipstick.

5. If the level is low, add oil of the proper type, up to the "F" mark on the dipstick. (Refer to "Oil Type" on page 4.) Always check the level with the dipstick before adding more oil.

NOTE: To prevent extensive engine wear or damage, always maintain the proper oil level in the crankcase. Never operate the engine with the oil level below the "L" mark or over the "F" mark on the dipstick.

Oil Sentry™

Some engines are equipped with an optional Oil Sentry™ oil pressure switch. If the oil pressure decreases below an acceptable level, the Oil Sentry™ will either shut off the engine or activate a warning signal, depending on the application.

NOTE: Make sure the oil level is checked **BEFORE EACH USE** and is maintained up to the “F” mark on the dipstick. This includes engines equipped with Oil Sentry™.

Change Oil and Oil Filter

Change Oil

Change oil after every **100 hours** of operation. Refill with service class SG, SH, SJ or higher oil as specified in the “Viscosity Grades” table (Figure 2) on page 4.

Change the oil while the engine is still warm. The oil will flow more freely and carry away more impurities. Make sure the engine is level when filling, checking, and changing the oil.

Change the oil as follows (see Figure 7):

1. To keep dirt, debris, etc., out of the engine, clean the area around the oil fill cap/dipstick before removing it.
2. Remove one of the oil drain plugs, oil fill cap, and dipstick. Be sure to allow ample time for complete drainage.
3. Reinstall the drain plug. Make sure it is tightened to **13.6 N·m (10 ft. lb.)** torque.
4. Fill the crankcase, with new oil of the proper type, to the “F” mark on the dipstick. Refer to “Oil Type” on page 4. Always check the level with the dipstick before adding more oil.
5. Reinstall the oil fill cap and tighten securely. Reinstall dipstick.

NOTE: To prevent extensive engine wear or damage, always maintain the proper oil level in the crankcase. Never operate the engine with the oil level below the “L” mark or over the “F” mark on the dipstick.

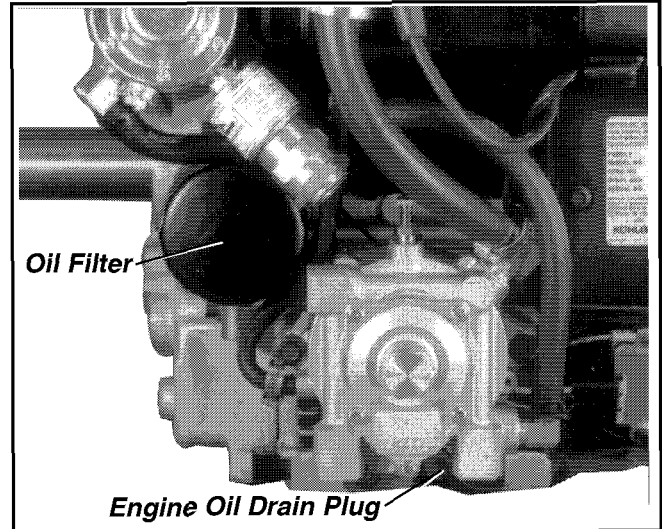

Figure 7. Oil Drain Plug and Oil Filter.

Change Oil Filter

Replace the oil filter **at least every other oil change (every 200 hours of operation)**. Always use a genuine Kohler oil filter, Part No. 12 050 01-S.

Replace the oil filter as follows:

1. Drain the oil from the engine crankcase by removing one of the drain plugs and allowing ample time for complete drainage.
2. Before removing the oil filter, clean the area around the oil filter to keep dirt and debris out of the engine. Remove the old filter. Wipe off the surface where the oil filter mounts.
3. Place a new replacement filter in a shallow pan with the open end up. Pour new oil of the proper type in through the threaded center hole. Stop pouring when the oil reaches the bottom of the threads. Allow a minute or two for the oil to be absorbed by the filter material.
4. Put a drop of oil on your fingertip and wipe it on the rubber gasket.
5. Install the new oil filter onto the filter adapter. Turn the oil filter clockwise until the rubber gasket contacts the mounting surface, then tighten the filter an additional **2/3 to 1 turn**.
6. Reinstall the drain plug. Make sure it is tightened to **13.6 N·m (10 ft. lb.)** torque.
7. Fill the crankcase with new oil of the proper type to the “F” mark on the dipstick.

8. Test run the engine to check for leaks. Stop the engine, allow a minute for the oil to drain down, and recheck the level on the dipstick. Add more oil as necessary so the oil level is up to but not over the "F" mark on the dipstick.

Service Precleaner and Air Cleaner Element

This engine is equipped with a replaceable, high density paper air cleaner element. Most engines are also equipped with an oiled, foam precleaner which surrounds the paper element. See Figures 8 and 9.

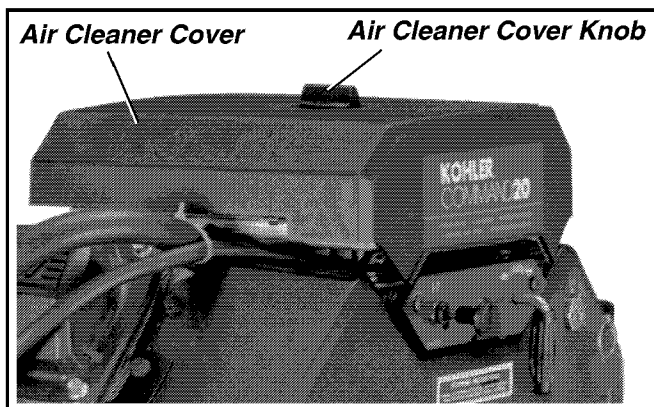

Figure 8. Air Cleaner Housing Components.

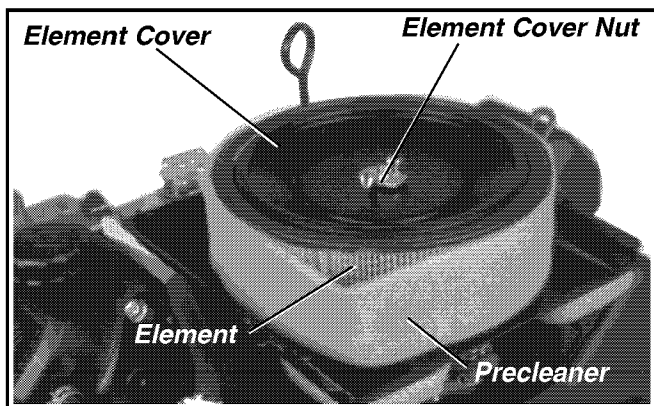

Figure 9. Air Cleaner System Components.

Check the air cleaner **daily or before starting the engine**. Check for a buildup of dirt and debris around the air cleaner system. Keep this area clean. Also check for loose or damaged components. Replace all bent or damaged air cleaner components.

NOTE: Operating the engine with loose or damaged air cleaner components could allow unfiltered air into the engine causing premature wear and failure.

Service Precleaner

If so equipped, wash and reoil the precleaner every **25 hours** of operation (more often under extremely dusty or dirty conditions).

1. Loosen the cover retaining knob and remove the cover.
2. Remove the precleaner from the paper element.
3. Wash the precleaner in warm water with detergent. Rinse the precleaner thoroughly until all traces of detergent are eliminated. Squeeze out excess water (do not wring). Allow the precleaner to air dry.
4. Saturate the precleaner with new engine oil. Squeeze out all excess oil.
5. Reinstall the precleaner over the paper element.
6. Reinstall the air cleaner cover. Secure cover with the cover retaining knob.
7. When precleaner replacement is necessary order genuine Kohler parts.

CH20-22	CH25
24 083 02-S	24 083 05-S

Service Paper Element

Every **100 hours** of operation (more often under extremely dusty or dirty conditions) replace the paper element.

1. Loosen the cover retaining knob and remove the air cleaner cover.
2. Remove the element cover nut, element cover, and paper element/precleaner.
3. Remove the precleaner (if so equipped) from the paper element and service as instructed above.
4. Do not wash the paper element or **use pressurized air**, as this will damage the element. Replace a dirty, bent, or damaged element with a genuine Kohler element. Handle new elements carefully; do not use if the sealing surfaces are bent or damaged.
5. When servicing the air cleaner, check the air cleaner base. Make sure it is secured and not bent or damaged. Also, check the element cover for damage or improper fit. Replace all damaged air cleaner components.

NOTE: Before air cleaner reassembly make sure rubber seal is in position around stud. Inspect, making sure it is not damaged and seals with the element cover.

6. Reinstall the paper element, precleaner, element cover, element cover nut, and air cleaner cover. Secure cover with cover retaining knob.

- When element replacement is necessary order genuine Kohler parts.

CH20-22	CH25
47 083 03-S	24 083 03-S

Clean Air Intake/Cooling Areas

To ensure proper cooling, make sure the flywheel screen, cooling fins, and other external surfaces of the engine are kept clean **at all times**.

Every **100 hours** of operation (more often under extremely dusty, dirty conditions), remove the blower housing and other cooling shrouds. Clean the cooling fins and external surfaces as necessary. Make sure the cooling shrouds are reinstalled.

NOTE: Operating the engine with a blocked flywheel screen, dirty or plugged cooling fins, and/or cooling shrouds removed, will cause engine damage due to overheating.

Ignition System

This engine is equipped with an electronic CD ignition system. Other than periodically checking/replacing the spark plugs, no maintenance, timing, or adjustments are necessary or possible with this system.

In the event starting problems should occur which are not corrected by replacing the spark plugs, see your Kohler Engine Service Dealer for trouble analysis.

Check Spark Plugs

Every **100 hours** of operation, remove the spark plugs, check condition, and reset the gap or replace with new plugs as necessary. **Every 300 hours or annually** replace the spark plugs. Replacement spark plugs are Kohler Part No. 12 132 02-S (Champion® type RC12YC). Equivalent alternate brand plugs can also be used.

- Before removing the spark plug, clean the area around the base of the plug to keep dirt and debris out of the engine.
- Remove the plug and check its condition. Replace the plug if worn or reuse is questionable.

NOTE: Do not clean the spark plugs in a machine using abrasive grit. Some grit could remain in the spark plug and enter the engine causing extensive wear and damage.

- Check the gap using a wire feeler gauge. Adjust the gap to **0.76 mm (0.030 in.)** by carefully bending the ground electrode. See Figure 10.
- Reinstall the spark plug into the cylinder head. Torque the spark plug to **24.4-29.8 N·m (18-22 ft. lb.)**.

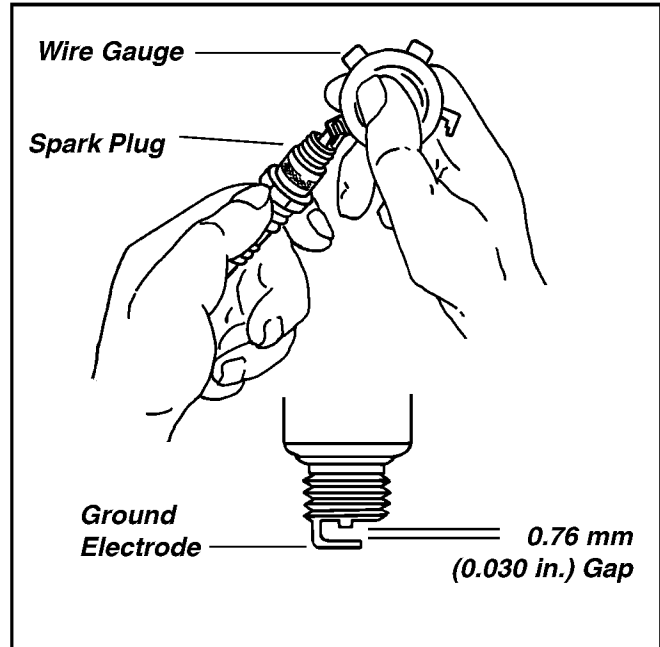

Figure 10. Servicing Spark Plug.

Battery Charging



WARNING: Explosive Gas!

Batteries produce explosive hydrogen gas while being charged. To prevent a fire or explosion, charge batteries only in well ventilated areas. Keep sparks, open flames, and other sources of ignition away from the battery at all times. Keep batteries out of the reach of children. Remove all jewelry when servicing batteries.

Before disconnecting the negative (-) ground cable, make sure all switches are OFF. If ON, a spark will occur at the ground cable terminal which could cause an explosion if hydrogen gas or LP/gasoline fuel vapors are present.

Charging of battery should be performed as outlined by the original equipment manufacturer (OEM) in their operator's manual.

Fuel Filter

The filter of the LP fuel system is an integral part within the lock-off/filter assembly. All service relating to the lock-off/filter is to be performed by an authorized Kohler Engine Service Dealer or qualified LP personnel only. Servicing of filter is recommended every 500 hours. The gasoline system (dual-fuel only) has an in-line fuel filter. Periodically inspect the filter and replace when dirty. Use a genuine Kohler filter, Part No. 24 050 02-S.

Carburetor Troubleshooting and Adjustments

In compliance with government emission standards, the carburetor and the regulator are calibrated and preset to deliver the correct fuel-to-air mixture to the engine under all operating conditions and cannot be adjusted, except for low idle speed. Carburetor servicing is to be performed by an authorized Kohler Engine Service Dealer only. See Figure 11.

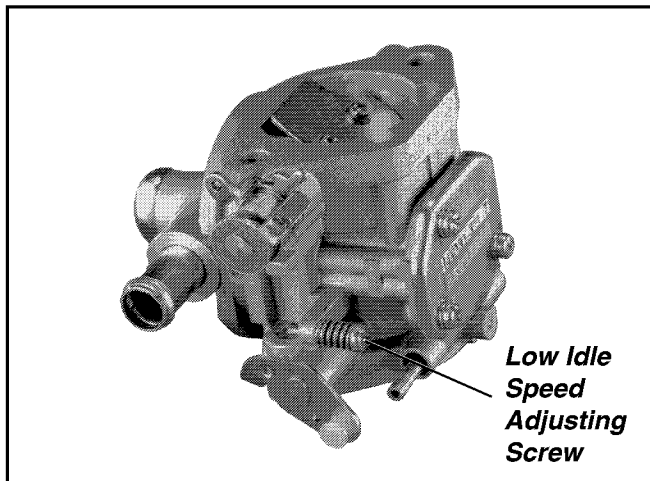

Figure 11.

LPG Regulator

In compliance with government emission standards, the regulator is preset at the factory to provide the proper supply of fuel. No adjustment or resetting of regulator is to be made. All service relating to the regulator must be performed by an authorized Kohler Engine Service Dealer or qualified LP personnel only.

Over time, fuel deposits can accumulate inside the regulator. Draining of these deposits is recommended (Nikki regulators only) every 500 operating hours, or annually, whichever comes first.

Nikki Regulators

Every 500 hours/annually drain regulator:

1. Turn fuel supply valve off, run engine out of fuel, and turn off ignition switch.
2. Disconnect and ground the spark plug leads.
3. Remove the 1/8" pipe plug from the bottom of regulator and drain any accumulated deposits. See Figure 12.

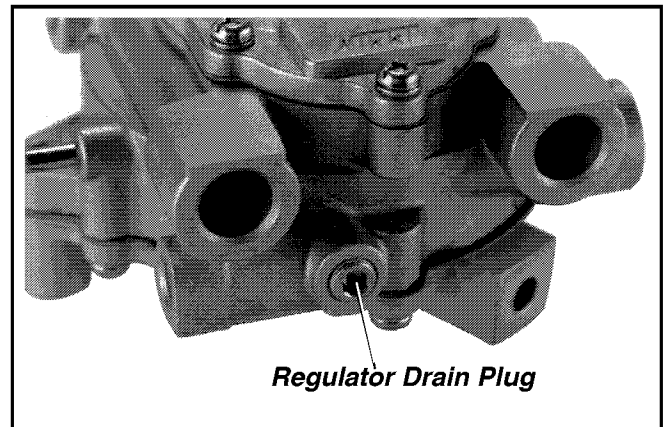

Figure 12. Nikki Regulator Drain Plug.

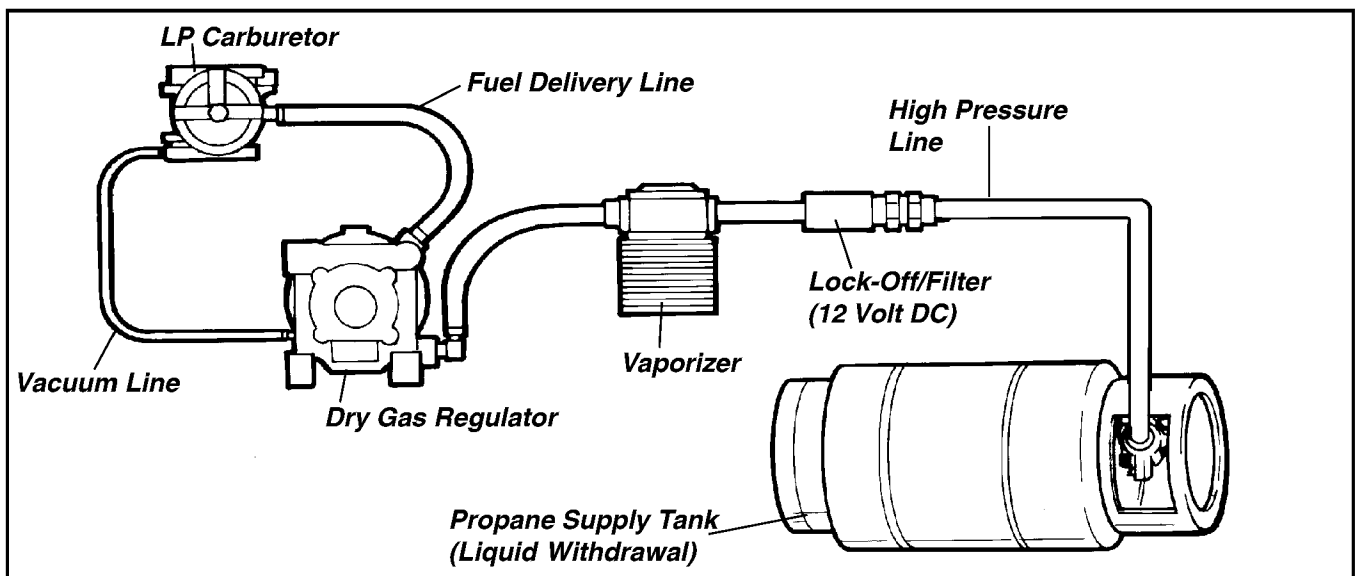

Figure 13. Schematic Showing Components of LP System.

- Reinstall plug using Teflon® pipe sealant (not Teflon® tape) on threads and tighten securely. If required, a replacement plug is available as Kohler Part No. X-75-23-S.

All Regulators

Every 1500 Hours:

Complete cleaning (disassembling, servicing, and resetting) of regulator at 1500 hour intervals is recommended. As all adjustments and settings must be reset using specific test equipment, this must be performed by an **authorized Kohler Engine Service Dealer or qualified LP personnel only.**

Lock-Off/Filter Assembly

This opens, closes, and filters the liquid fuel flow from the supply tank before reaching the vaporizer. Servicing, if required, is to be performed by an authorized Kohler Engine Service Dealer or qualified LP personnel only. See Figure 13.

Vaporizer

The vaporizer changes the Liquified Petroleum (LP) from the supply tank to a gaseous/vapor state. Other than keeping the body clean, no maintenance, adjustment, or servicing is required. See Figure 13.

Leakage Check/Testing

Every 500 hours or annually. With LPG tank valve fully opened, engine not running, turn key switch “**on.**” Check all LPG system connections and lines for leaks using soapy water. Any leakage must be corrected **before** restarting engine. Have service performed by an authorized Kohler Engine Service Dealer or qualified LP personnel only.

Troubleshooting - Fuel Related

If engine problems are experienced that appear to be fuel system related, check the following areas before seeking service assistance.

- Make sure the LPG tank is properly filled (never to more than 80 percent of total capacity). An air space must be present in the tank to allow fuel to expand.
- Make sure the air cleaner element is clean and all air cleaner components are fastened securely.
- Check for loose, kinked, or cracked vacuum lines causing regulator not to open.
- Check to make sure the fuel valve on LPG tank is fully open.
- Check gauge on LPG tank to make sure pressure is sufficient to open the regulator.
- For problems with the gasoline system (dual-fuel), check that there is adequate fresh fuel in the tank, the fuel valve at the tank (if so equipped) is open, the fuel tank cap is properly vented, the lines are not kinked or blocked, and that the in-line filter is not dirty or restricted.

If after checking the items listed above, the engine is hard to start, runs roughly, or stalls at low idle speed, qualified fuel system servicing may be necessary. Contact your nearest authorized Kohler Engine Service Dealer for further assistance.

Troubleshooting

When troubles occur, be sure to check the simple causes which at first may seem too obvious to be considered. For example, a starting problem could be caused by an empty fuel tank. Some common causes of engine troubles are listed in the following table.

Do not attempt to service or replace major engine components, or any items that require special timing or adjustment procedures. Have your Kohler Engine Service Dealer do this work.

Cause Problem	No Fuel	Improper Fuel	Dirt In Fuel Line	Dirty/Restricted Lock-off Fuel Filter	Dirty Flywheel Screen	Incorrect Oil Level	Engine Overloaded	Dirty Air Cleaner	Faulty Spark Plug	Dirty/Possible Restricted Regulator
Will Not Start	•		•	•	•	•	•	•	•	•
Hard Starting	•	•	•	•	•	•	•	•	•	•
Stops Suddenly	•		•	•	•	•	•	•		•
Lacks Power		•	•	•	•	•	•	•	•	•
Operates Erratically		•	•	•	•		•	•	•	•
Knocks or Pings		•		•	•		•		•	•
Skips or Misfires		•	•	•	•			•	•	•
Backfires			•	•				•	•	•
Overheats		•	•	•	•	•	•	•		•
High Fuel Consumption								•	•	

Storage

When the engine is not in use, use the following storage procedure. Federal, state, or local laws governing LPG fuel tank storage may also apply. Follow the applicable storage laws.

1. Clean the exterior surfaces of the engine.
2. Change the oil and filter while the engine is still warm from operation. See "Change Oil and Oil Filter" on page 10.
3. Turn valve on LPG tank off and run engine until the fuel system is empty. Turn ignition key switch off. Separate LPG tank from the unit and store separately in an area designated for safe LPG tank storage. On dual-fuel units, the gasoline fuel system must be completely emptied, or the gasoline must be treated with a stabilizer to prevent deterioration. If you choose to use a stabilizer, follow the manufacturer's recommendations, and add the correct amount for the capacity of the fuel system. Fill the fuel tank with clean, fresh gasoline. Run the engine for 2-3 minutes to get stabilized fuel into the carburetor. Close fuel shut-off valve when unit is being stored or transported.
4. Remove the spark plugs. Add one tablespoon of engine oil into each spark plug hole. Install the plugs, but do not connect the plug leads. Crank the engine two or three revolutions.

Specifications

Model:	CH20-22	CH25
Bore:	77 (3.03)	83 (3.27)
Stroke:	67 (2.64)	67 (2.64)
Displacement:	624 (38.1)	725 (44.0)
Power (@3600 RPM):	14.9 (20*)	18.4 (25*)
Max. Torque (@RPM):	44 (32) @2500	54 (39.5) @2400
Compression Ratio:	8.5:1	9.0:1
Weight:	41 (90)	43 (94)
Oil Capacity (w/filter):	2 (2.1)	2 (2.1)
Lubrication:	Full Pressure w/full Flow Filter	

Exhaust Emission Control System for models CH20 LP, CH25 LP, and CH25 Dual Fuel (open loop) is EM.
Exhaust Emission Control System for model CH25 Dual Fuel (closed loop) is EM, O2S, ECM.

*Horsepower ratings are established in accordance with Society of Automotive Engineers – Small Engine Test Code – J1995 GROSS. Kohler Co. reserves the right to change product specifications, design, and standard equipment without notice and without incurring obligation. A horsepower reduction of approximately 10 percent may be expected with the operation and use of LPG as fuel.

5. Store the engine in a clean, dry place. Store the fuel tank in a designated safe LPG storage area at all times when not in use.

Parts Ordering

The engine Specification, Model, and Serial Numbers are required when ordering replacement parts from your Kohler Engine Service Dealer. These numbers are found on the identification plate which is affixed to the engine shrouding. Include letter suffixes if there are any. See "Engine Identification Numbers" on page 6.

Always insist on genuine Kohler parts. All genuine Kohler parts meet strict standards for fit, reliability, and performance.

Major Repair

Major repair information is available in Kohler Engine Service Manuals. However, major repair generally requires the attention of a trained mechanic and the use of special tools and equipment. Your Kohler Engine Service Dealer has the facilities, training, and genuine Kohler replacement parts necessary to perform this service. For Sales & Service assistance call 1-800-544-2444 (U.S. & Canada) or contact your Kohler Engine Dealer or Service Distributor, they're in the Yellow Pages under Engines-Gasoline.

LIMITED 2 YEAR COMMAND ENGINE WARRANTY

We warrant to the original consumer that each new Command engine sold by us will be free from manufacturing defects in materials or workmanship in normal service for a period of two (2) years from date of purchase, provided it is operated and maintained in accordance with Kohler Co.'s instructions and manuals.

Our obligation under this warranty is expressly limited, at our option, to the replacement or repair at Kohler Co., Kohler, Wisconsin 53044, or at a service facility designated by us of such parts as inspection shall disclose to have been defective.

EXCLUSIONS:

Mufflers on engines used commercially (non-residential) are warranted for one (1) year from date of purchase, except catalytic mufflers, which are warranted for two (2) years.

This warranty does not apply to defects caused by casualty or unreasonable use, including faulty repairs by others and failure to provide reasonable and necessary maintenance.

The following items are not covered by this warranty:

Engine accessories such as fuel tanks, clutches, transmissions, power-drive assemblies, and batteries, unless supplied or installed by Kohler Co. These are subject to the warranties, if any, of their manufacturers.

WE SHALL NOT BE LIABLE FOR SPECIAL, INDIRECT, INCIDENTAL, OR CONSEQUENTIAL DAMAGES OF ANY KIND, including but not limited to labor costs or transportation charges in connection with the repair or replacement of defective parts.

ANY IMPLIED OR STATUTORY WARRANTIES, INCLUDING WARRANTY OF MERCHANTABILITY OR FITNESS FOR A PARTICULAR PURPOSE, ARE EXPRESSLY LIMITED TO THE DURATION OF THIS WRITTEN WARRANTY. We make no other express warranty, nor is any one authorized to make any in our behalf.

Some states do not allow limitations on how long an implied warranty lasts, or the exclusion or limitation of incidental or consequential damages, so the above limitation or exclusion may not apply to you.

This warranty gives you specific legal rights, and you may also have other rights which vary from state to state.

TO OBTAIN WARRANTY SERVICE:

Purchaser must bring the engine to an authorized Kohler service facility. For the facility nearest you, consult your Yellow Pages or write Kohler Co., Attn: Engine Warranty Service Dept., Kohler, Wisconsin, 53044.

ENGINE DIVISION, KOHLER CO., KOHLER, WISCONSIN 53044

KOHLER CO. FEDERAL AND CALIFORNIA EMISSION CONTROL SYSTEMS LIMITED WARRANTY SMALL OFF-ROAD ENGINES

The U.S. Environmental Protection Agency (EPA), the California Air Resources Board (CARB), and Kohler Co. are pleased to explain the Federal and California Emission Control Systems Warranty on your small off-road equipment engine. For California, engines produced in 1995 and later must be designed, built and equipped to meet the state's stringent anti-smog standards. In other states, 1997 and later model year engines must be designed, built and equipped, to meet the U.S. EPA regulations for small non-road engines. The engine must be free from defects in materials and workmanship which cause it to fail to conform with U.S. EPA standards for the first two years of engine use from the date of sale to the ultimate purchaser. Kohler Co. must warrant the emission control system on the engine for the period of time listed above, provided there has been no abuse, neglect or improper maintenance.

The emission control system may include parts such as the carburetor or fuel injection system, the ignition system, and catalytic converter. Also included are the hoses, belts and connectors and other emission related assemblies.

Where a warrantable condition exists, Kohler Co. will repair the engine at no cost, including diagnosis (if the diagnostic work is performed at an authorized dealer), parts and labor.

MANUFACTURER'S WARRANTY COVERAGE

Engines produced in 1995 or later are warranted for two years in California. In other states, 1997 and later model year engines are warranted for two years. If any emission related part on the engine is defective, the part will be repaired or replaced by Kohler Co. free of charge.

OWNER'S WARRANTY RESPONSIBILITIES

- (a) The engine owner is responsible for the performance of the required maintenance listed in the owner's manual. Kohler Co. recommends that you retain all receipts covering maintenance on the engine, But Kohler Co. cannot deny warranty solely for the lack of receipts or for your failure to assure that all scheduled maintenance was performed.
- (b) Be aware, however, that Kohler Co. may deny warranty coverage if the engine or a part has failed due to abuse, neglect, improper maintenance or unapproved modifications.

Continued on next page.

- (c) For warranty repairs, the engine must be presented to a Kohler Co. service center as soon as a problem exists. Call 1-800-544-2444 or access our website at www.kohlerengines.com, for the names of the nearest service centers. The warranty repairs should be completed in a reasonable amount of time, not to exceed 30 days.

If you have any questions regarding warranty rights and responsibilities, you should contact Kohler Co. at 1-920-457-4441 and ask for an Engine Service representative.

COVERAGE

Kohler Co. warrants to the ultimate purchaser and each subsequent purchaser that the engine will be designed, built and equipped, at the time of sale, to meet all applicable regulations. Kohler Co. also warrants to the initial purchaser and each subsequent purchaser, that the engine is free from defects in materials and workmanship which cause the engine to fail to conform with applicable regulations for a period of two years.

Engines produced in 1995 or later are warranted for two years in California. For 1997 and later model years, EPA requires manufacturers to warrant engines for two years in all other states. These warranty periods will begin on the date the engine is purchased by the initial purchaser. If any emission related part on the engine is defective, the part will be replaced by Kohler Co. at no cost to the owner. Kohler Co. is liable for damages to other engine components caused by the failure of a warranted part still under warranty.

Kohler Co. shall remedy warranty defects at any authorized Kohler Co. engine dealer or warranty station. Warranty repair work done at an authorized dealer or warranty station shall be free of charge to the owner if such work determines that a warranted part is defective.

Listed below are the parts covered by the Federal and California Emission Control Systems Warranty. Some parts listed below may require scheduled maintenance and are warranted up to the first scheduled replacement point for that part. The warranted parts are:

- Oxygen sensor (if equipped)
- Intake manifold (if equipped)
- Exhaust manifold (if equipped)
- Catalytic muffler (if equipped)
- Fuel metering valve (if equipped)
- Spark advance module (if equipped)
- Crankcase breather
- Ignition module(s) with high tension lead
- Gaseous fuel regulator (if equipped)
- Electronic control unit (if equipped)
- Carburetor or fuel injection system
- Fuel lines (if equipped)
- Air filter, fuel filter, and spark plugs (only to first scheduled replacement point)

LIMITATIONS

This Emission Control Systems Warranty shall not cover any of the following:

- (a) repair or replacement required because of misuse or neglect, improper maintenance, repairs improperly performed or replacements not conforming to Kohler Co. specifications that adversely affect performance and/or durability and alterations or modifications not recommended or approved in writing by Kohler Co.,
- (b) replacement of parts and other services and adjustments necessary for required maintenance at and after the first scheduled replacement point,
- (c) consequential damages such as loss of time, inconvenience, loss of use of the engine or equipment, etc.,
- (d) diagnosis and inspection fees that do not result in eligible warranty service being performed, and
- (e) any add-on or modified part, or malfunction of authorized parts due to the use of add-on or modified parts.

MAINTENANCE AND REPAIR REQUIREMENTS

The owner is responsible for the proper use and maintenance of the engine. Kohler Co. recommends that all receipts and records covering the performance of regular maintenance be retained in case questions arise. If the engine is resold during the warranty period, the maintenance records should be transferred to each subsequent owner. Kohler Co. reserves the right to deny warranty coverage if the engine has not been properly maintained; however, Kohler Co. may not deny warranty repairs solely because of the lack of repair maintenance or failure to keep maintenance records.

Normal maintenance, replacement or repair of emission control devices and systems may be performed by any repair establishment or individual; however, **warranty repairs must be performed by a Kohler authorized service center.** Any replacement part or service that is equivalent in performance and durability may be used in non-warranty maintenance or repairs, and shall not reduce the warranty obligations of the engine manufacturer.

FOR SALES AND SERVICE INFORMATION
IN U.S. AND CANADA, CALL
1-800-544-2444

KOHLER engines
BORN TO RUN™

ENGINE DIVISION, KOHLER CO., KOHLER, WISCONSIN 53044

FORM NO.:	TP-2483-C
ISSUED:	10/96
REVISED:	12/01
MAILED:	

LITHO IN U.S.A.