

iron ton™

5855016

Canopy and Enclosure with Windows,20ftx10ft..White



1.

Find out (A,B,1,2)parts,and place them according to the position of the parts in the picture.

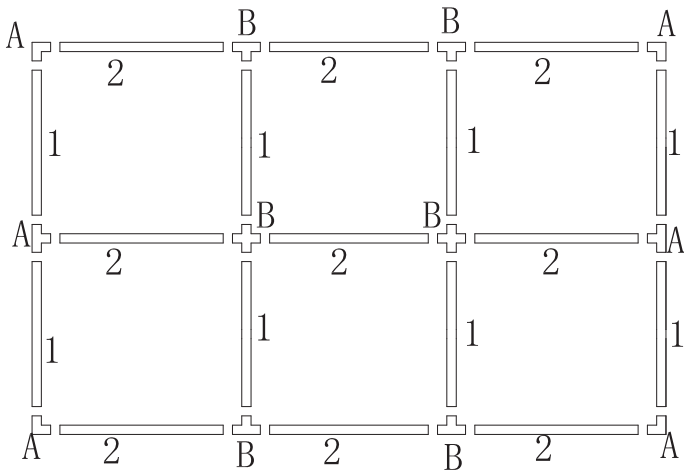

2.

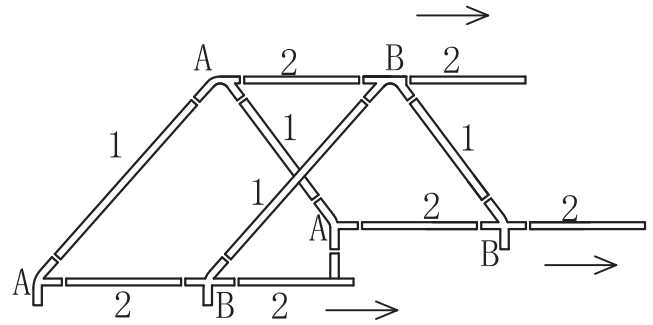

Assemble the Steel Pipe(1,2) to the 3-way Corner Connector(A) and 4-way Corner Connector(B)

3.

Assemble the rest of Steel Pipe (1,2) according to the previous steps

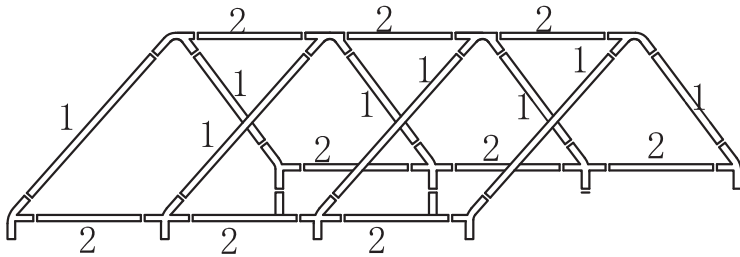

4.

Put the Top Cover on the top frame.

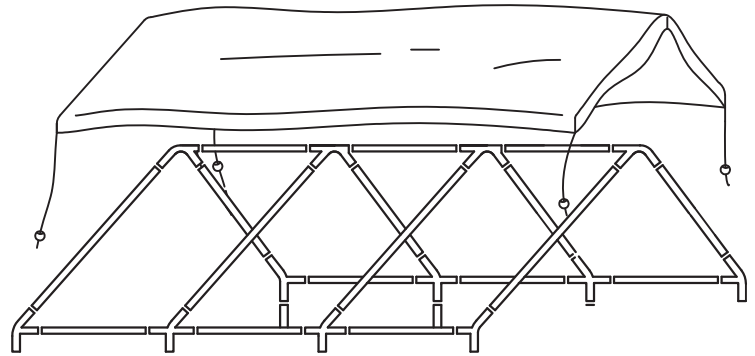

5.

Assemble a Steel Pipe(3) to each end of every Connector(A,B).

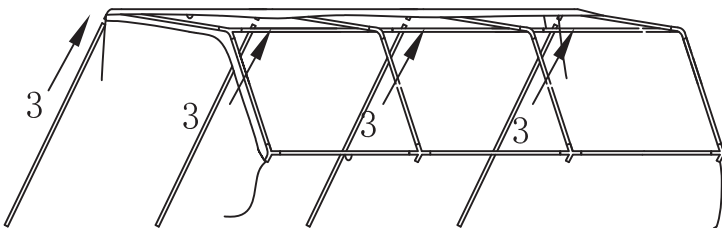

6.

Assemble the Door Cover to the Steel Pipe(1) with the Bungee Cord

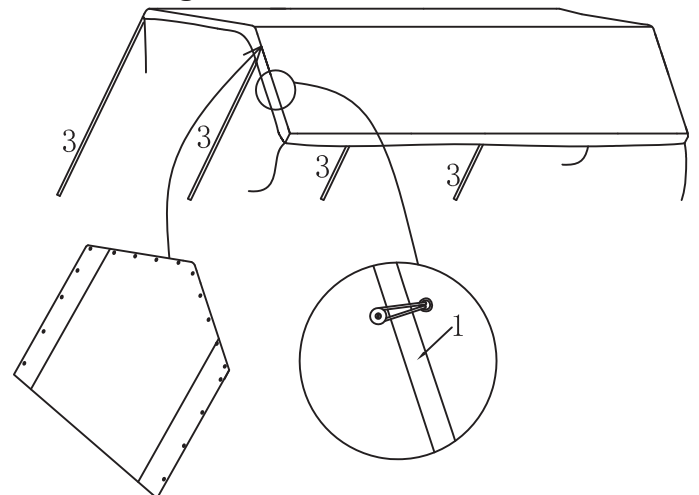

7.

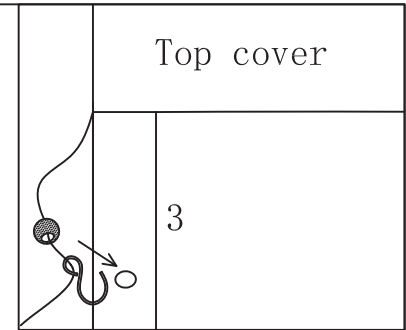
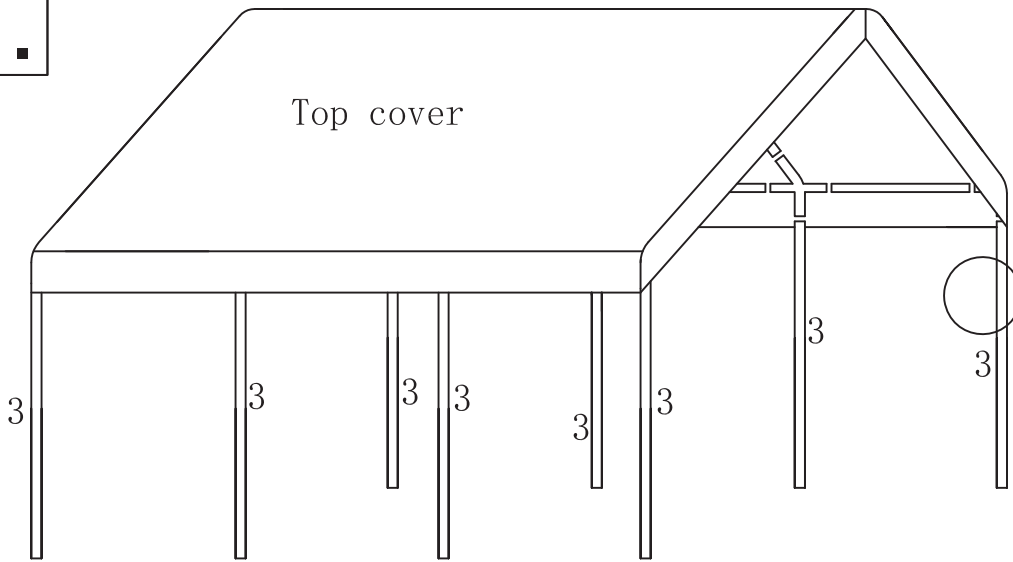

Secure the four corners to the the corner legs using Hanger.

8.

Assemble two Side Walls to the Steel frame with the Bungee Cords.

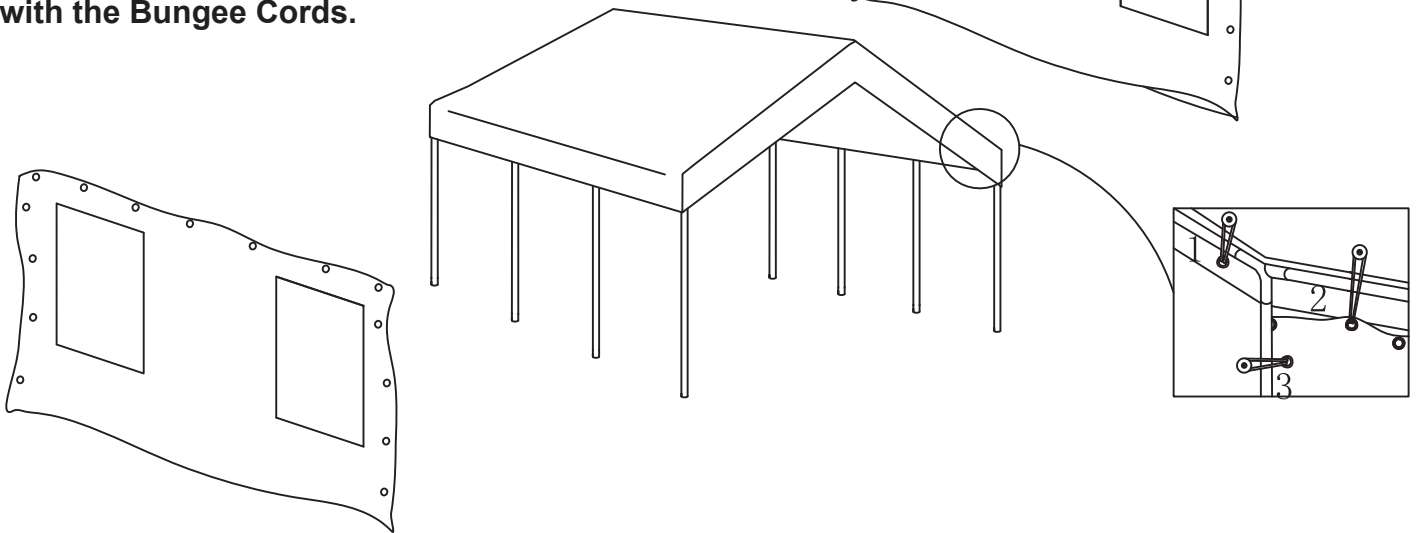

9.

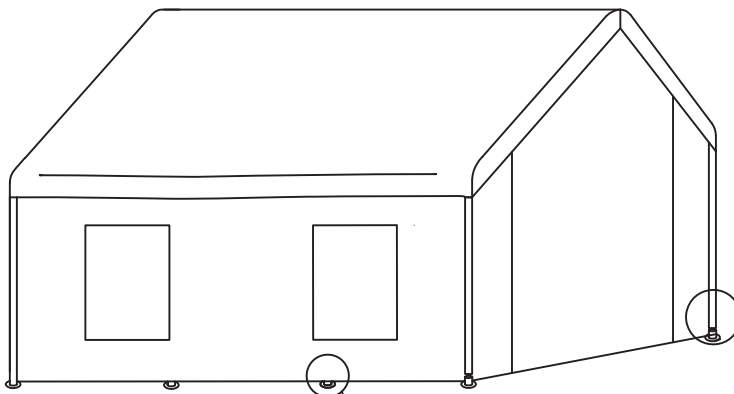

Assemble the steel pipe(3) to the foot plate(C) with screw.

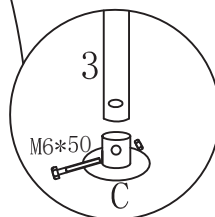

10.

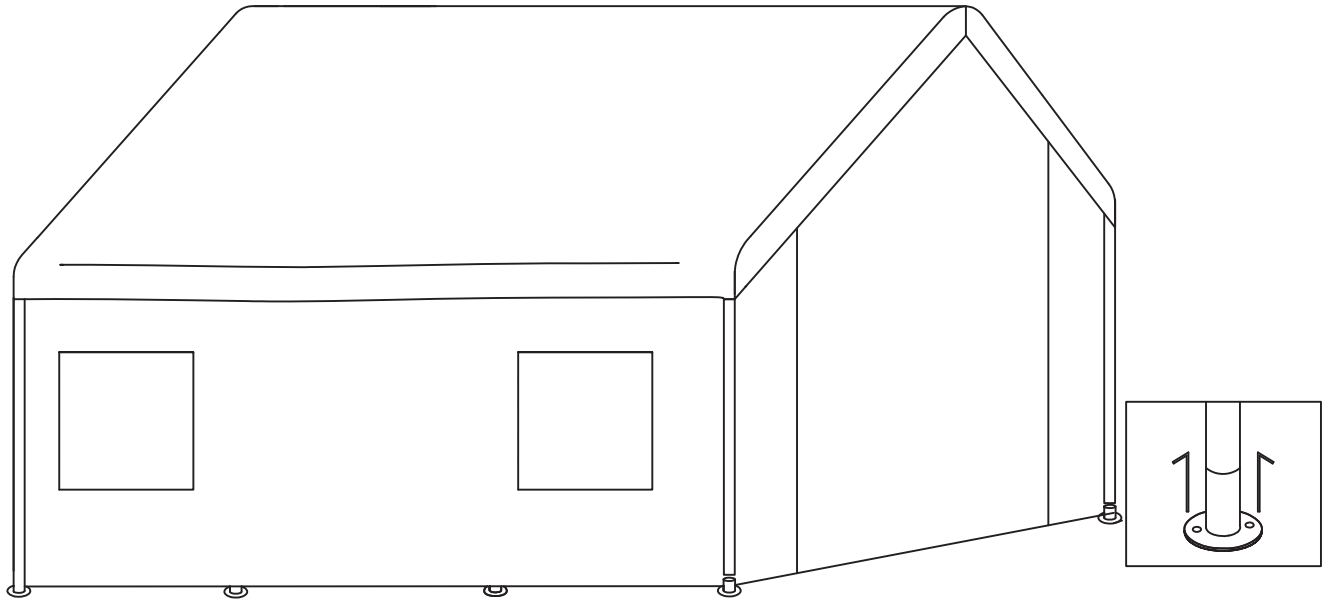

Assemble the Foot Plate to the ground with the Ground Peg.

11.

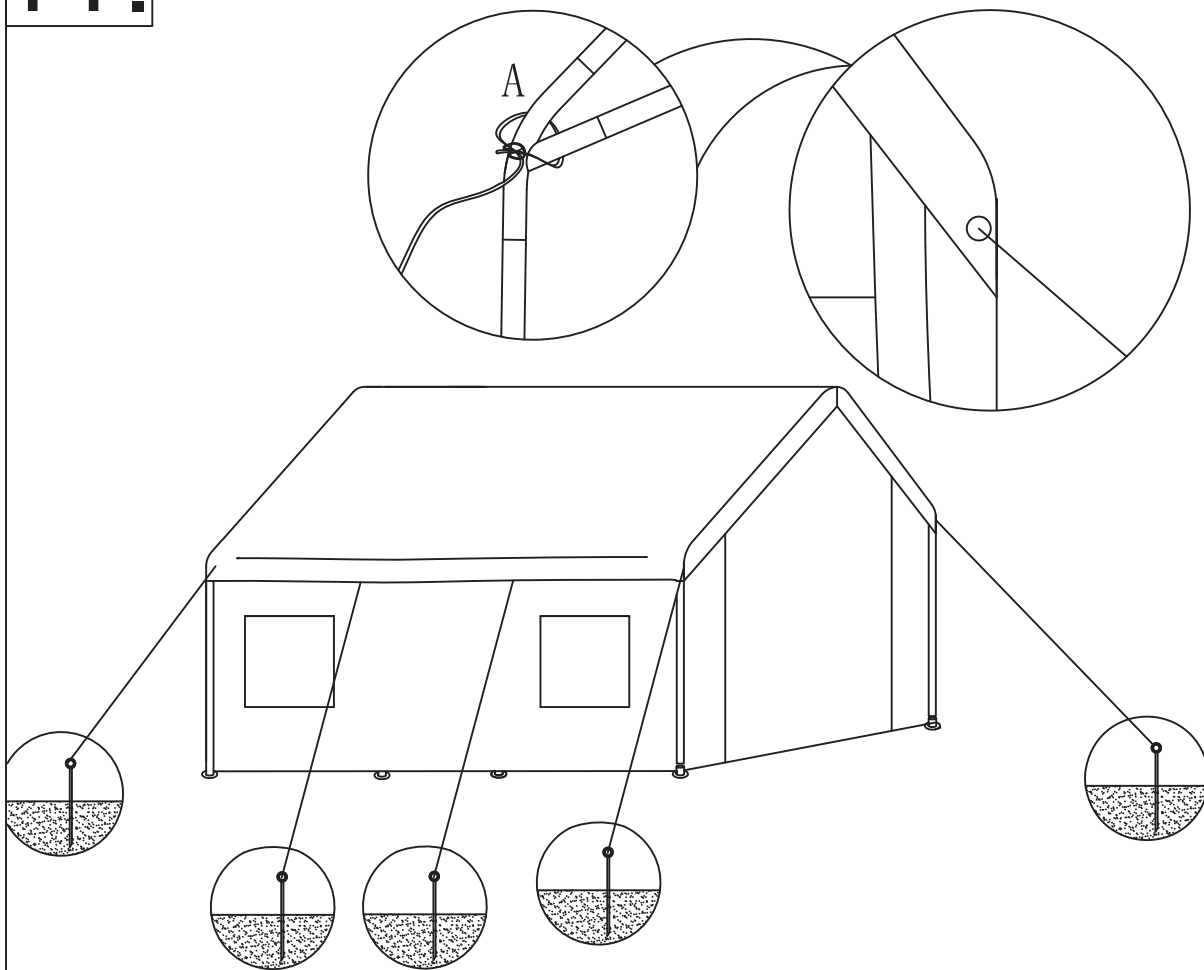

One end of the Rope needs to be passing through the gap in the side of Top Cover and tied to the 3-way CornerConnector(A).The other end needs tied to the Anchor.And then insert the Anchor into the ground.