



150-Lb. Drywall and Panel Hoist

Owner's Manual



⚠ WARNING: Read carefully and understand all ASSEMBLY AND OPERATION INSTRUCTIONS before operating. Failure to follow the safety rules and other basic safety precautions may result in serious personal injury.

Item #57395

READ & SAVE THESE INSTRUCTIONS

Thank you very much for choosing a Strongway™ product!

For future reference, please complete the owner's record below:

Serial Number/Lot Date Code: _____

Purchase Date: _____

Save the receipt, warranty, and this manual. It is important that you read the entire manual to become familiar with this product before you begin using it.

This hoist is designed for certain applications only. Northern Tool and Equipment is not responsible for issues arising from modification or improper use of this product such as an application for which it was not designed. We strongly recommend that this product not be modified and/or used for any application other than that for which it was designed.

For technical questions, please call **1-800-222-5381**.

Table of Contents

Intended Use.....4

Technical Specifications4

Important Safety Information4

Specific Operation Warnings6

Assembly Instructions.....7

Operating Instructions.....11

Maintenance13

Troubleshooting.....13

Parts Diagram.....15

Parts List.....15

Replacement Parts16

Limited Warranty.....17

Intended Use

The Strongway 150-Lb. Drywall and Panel Hoist is a manual tool for lifting panels for ceilings and false ceilings. The gears and pulley system allow you to exert less physical effort when working.

Technical Specifications

Property	Specification
Max lift height (ft.)	15
Rotation	360°
Max load capacity (lb.)	150
Casters (in.)	5 (3)
Max load size (ft.)	4 x 16

Important Safety Information

⚠WARNING

- Read and understand all instructions. Failure to follow all instructions may result in serious injury or property damage.
- The warnings, cautions, and instructions in this manual cannot cover all possible conditions or situations that could occur. Exercise common sense and caution when using this tool. Always be aware of the environment and ensure that the tool is used in a safe and responsible manner.
- Do not allow persons to operate or assemble the product until they have read this manual and have developed a thorough understanding of how it works.
- Do not modify this product in any way. Unauthorized modification may impair the function and/or safety and could affect the life of the product. There are specific applications for which the product was designed.
- Use the right tool for the job. DO NOT attempt to force small equipment to do the work of larger industrial equipment. There are certain applications for which this equipment was designed. This product will be safer and do a better job at the capacity for which it was intended. DO NOT use this equipment for a purpose for which it was not intended.
- Industrial or commercial applications must follow OSHA requirements.

⚠WARNING

WORK AREA SAFETY

- Inspect the work area before each use. Keep work area clean, dry, free of clutter, and well-lit. Cluttered, wet, or dark work areas can result in injury. Using the product in confined work areas may put you dangerously close to cutting tools and rotating parts.
- Do not use the product where there is a risk of causing a fire or an explosion; e.g., in the presence of flammable liquids, gases, or dust. The product can create sparks, which may ignite the flammable liquids, gases, or dust.
- Do not allow the product to come into contact with an electrical source. The tool is not insulated

and contact will cause electrical shock.

- Keep children and bystanders away from the work area while operating the tool. Do not allow children to handle the product.
- Be aware of all power lines, electrical circuits, water pipes, and other mechanical hazards in your work area. Some of these hazards may be hidden from your view and may cause personal injury and/or property damage if contacted.

⚠ WARNING

PERSONAL SAFETY

- Stay alert, watch what you are doing, and use common sense when operating the tool. Do not use the tool while you are tired or under the influence of drugs, alcohol, or medication. A moment of inattention while operating the tool may result in serious personal injury.
- Dress properly. Do not wear loose clothing, dangling objects, or jewelry. Keep your hair, clothing and gloves away from moving parts. Loose clothes, jewelry, or long hair can be caught in moving parts. Air vents on the tool often cover moving parts and should be avoided.
- Wear the proper personal protective equipment when necessary. Use ANSI Z87.1 compliant safety goggles (not safety glasses) with side shields, or when needed, a face shield. Use a dust mask in dusty work conditions. Also use non-skid safety shoes, hardhat, gloves, dust collection systems, and hearing protection when appropriate. This applies to all persons in the work area.
- Do not overreach. Keep proper footing and balance at all times.
- Remove keys or wrenches before connecting the tool to an air supply, power supply, or turning on the tool. A wrench or key that is left attached to a rotating part of the tool may cause personal injury.
- Secure the work with clamps or a vise instead of your hand when practical. This safety precaution allows for proper tool operation using both hands.

⚠ CAUTION

PRODUCT USE AND CARE

- Do not force the product. Products are safer and do a better job when used in the manner for which they are designed. Plan your work, and use the correct product for the job.
- Check for damaged parts before each use. Carefully check that the product will operate properly and perform its intended function. Replace damaged or worn parts immediately. Never operate the product with a damaged part.
- Do not use a product with a malfunctioning switch. Any power tool that cannot be controlled with the power switch is dangerous and must be repaired by an authorized service representative before using.
- Disconnect the power/air supply from the product and place the switch in the locked or off position before making any adjustments, changing accessories, or storing the tool. Such preventive safety measures reduce the risk of starting the tool accidentally.
- Store the product when it is not in use. Store it in a dry, secure place out of the reach of children.

Inspect the tool for good working condition prior to storage and before re-use.

- Use only accessories that are recommended by the manufacturer for use with your product. Accessories that may be suitable for one product may create a risk of injury when used with another tool. Never use an accessory that has a lower operating speed or operating pressure than the tool itself.
- Keep guards in place and in working order. Never operate the product without the guards in place.
- Do not leave the tool running unattended.

Specific Operation Warnings

⚠ WARNING

- To avoid injury, slide bar lock must be fully engaged if winch assembly is extended.
- Wear ANSI Z87.1 compliant safety goggles, hard hat, heavy duty gloves, and steel toed boots during setup and use.
- Do not exceed the rated load capacity.
- Do not use to transport people or pets.
- Secure load before raising or lowering load.
- Only use the hoist to raise and lower one panel at a time.
- Never load a drywall panel or operate the hoist if the lock pins are not engaged at one of the three positions.
- Use ONLY for lifting a drywall panel.
- To avoid serious injury, watch for overhead obstructions when raising panel.
- Cradle drops rapidly when brake arm is released.
- Control the winch with your right hand on wheel handle BEFORE releasing brake.
- Be sure the winch components are clean and dry before operation.
- Inspect the tool for wear or damage. Pay special attention to any wear or damage to the wire rope.
- Carefully inspect the hoist before operating.
- The hoist is built and designed to vertically lift plasterboards. Before lifting, be sure that the load is positioned strictly at the center of the cradle.
- When taking the shelves off the control handle, hold the control handle tightly to avoid injury.

Assembly Instructions

1. Install the two shelves onto the cradle with a butterfly nut.



2. Install the two side shelves onto the shelves with a butterfly nut.

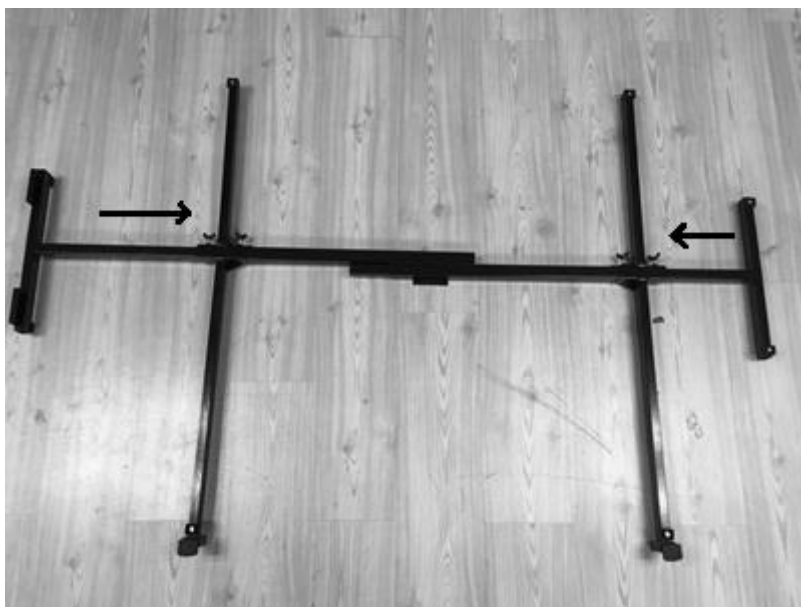

3. Insert the legs into the leg housing of the central column.



4. Pull the anchor when inserting the leg and release it. Make sure it fits into the hole of the leg. Also make sure that the legs do not slip from the housing when pulled.



5. Place the rack into the central column.



6. When the rack is inserted into the central column completely, it should look like this:



7. Place the control handle into the rack and attach with a butterfly nut.

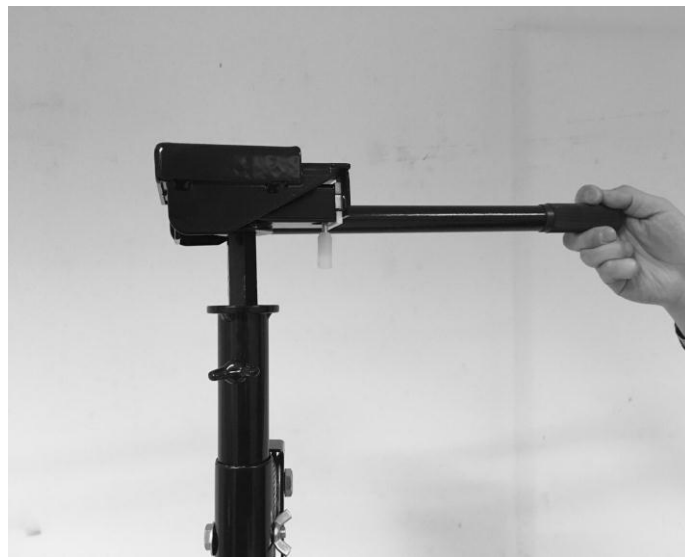

8. Push the white button to release the control handle from the unit. Push the handle up and hold it carefully.

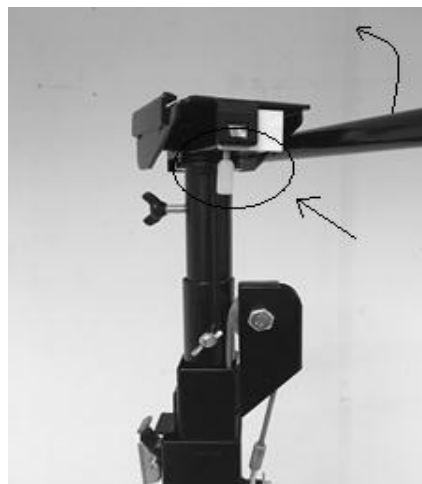

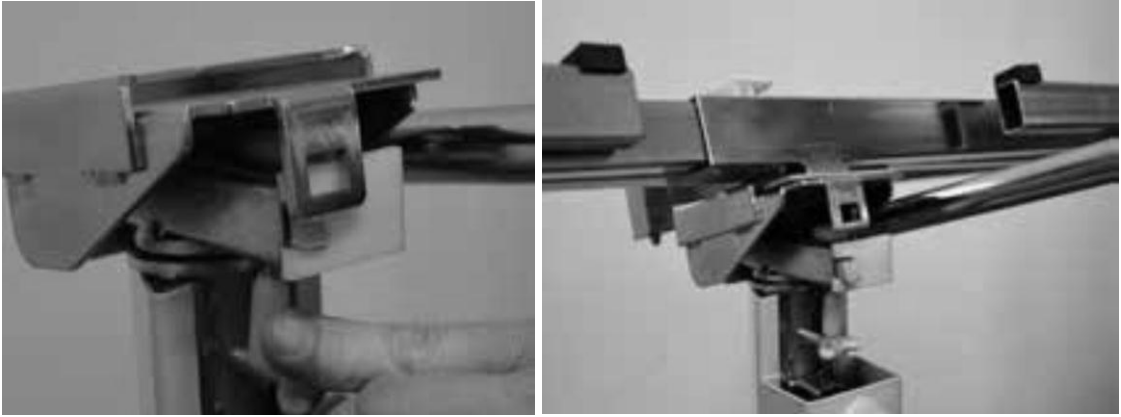

9. Place the cradle onto the control handle.



Operating Instructions

⚠WARNING

- Wear ANSI Z87.1 compliant safety goggles, hard hat, heavy duty gloves, and steel toed boots during setup and use.
- Do not exceed the rated load capacity.
- Do not use to transport people or pets.
- Secure load before raising or lowering load.
- Only use the hoist to raise and lower one panel at a time.
- Never load a drywall panel or operate the hoist if the lock pins are not engaged at one of the three positions.
- Use ONLY for lifting a drywall panel.
- To avoid serious injury, watch for overhead obstructions when raising panel.
- Cradle drops rapidly when brake arm is released.
- Control the winch with your right hand on wheel handle BEFORE releasing brake.
- The hoist is built and designed to vertically lift plasterboards. Before lifting, be sure that the load is positioned strictly at the center of the cradle.
- When taking the shelves off the control handle, hold the control handle tightly to avoid injury.
- Do not force the lever counter-clockwise or it will break the stop lock and clutch disks.

1. Lock the brakes on the castors while in position.

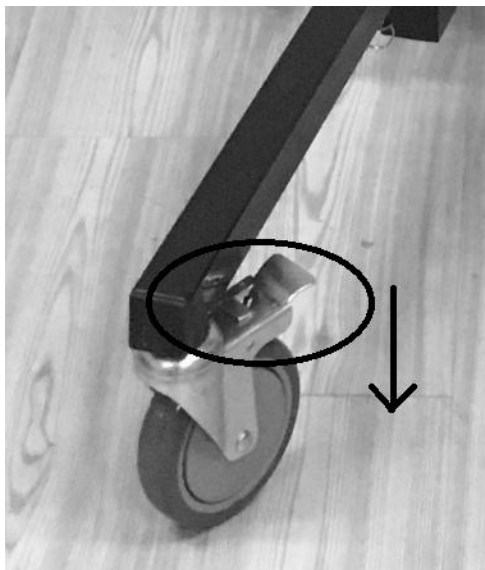

2. Place the board on the extension of the cradle.



3. Pull the control handle down to the horizontal position.



4. To raise the cradle by turning the rotating crank, turn the handle clockwise, keeping the other hand firmly on the handlebars. Lift up to the desired height with the desired direction. Now the board can be attached to the ceiling.

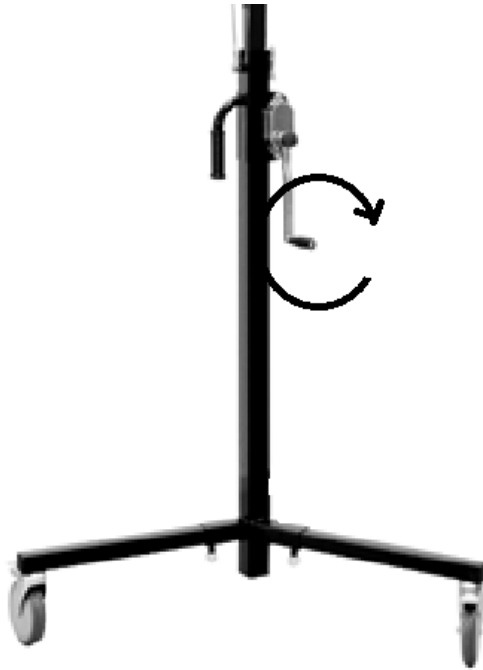

Maintenance



Maintain the product by adopting a program of conscientious repair and maintenance in accordance with the following recommended procedures. It is recommended that the general condition of any tool be examined before it is used. Keep your tool in good repair. Keep handles dry, clean, and free from oil and grease. The following chart is based on a normal operation schedule.

Maintenance Interval	Maintenance Point
Daily before and after operating	Clean the machine completely, in particular the sliding parts and the gear-pulley assembly.

Troubleshooting

Use the table below to troubleshoot problems before contacting service personnel or your local dealer. If the problem continues after troubleshooting, call your local dealer for assistance.

Failure	Possible Cause	Corrective Action
The drywall won't move.	The castors are locked by brake.	Release the brake on castors.
The cradle won't fall.	The locking device is open like the image below.	Check the locking device and lock as shown here.

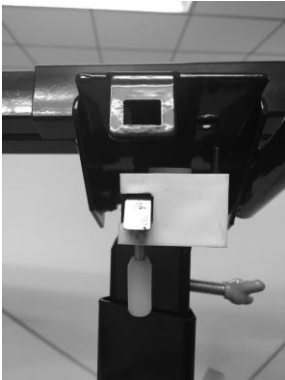
Failure	Possible Cause	Corrective Action
		
<p>The cradle won't move.</p>	<p>The control handle is locked as shown here.</p> 	<p>Release the control handle.</p> 

Parts Diagram

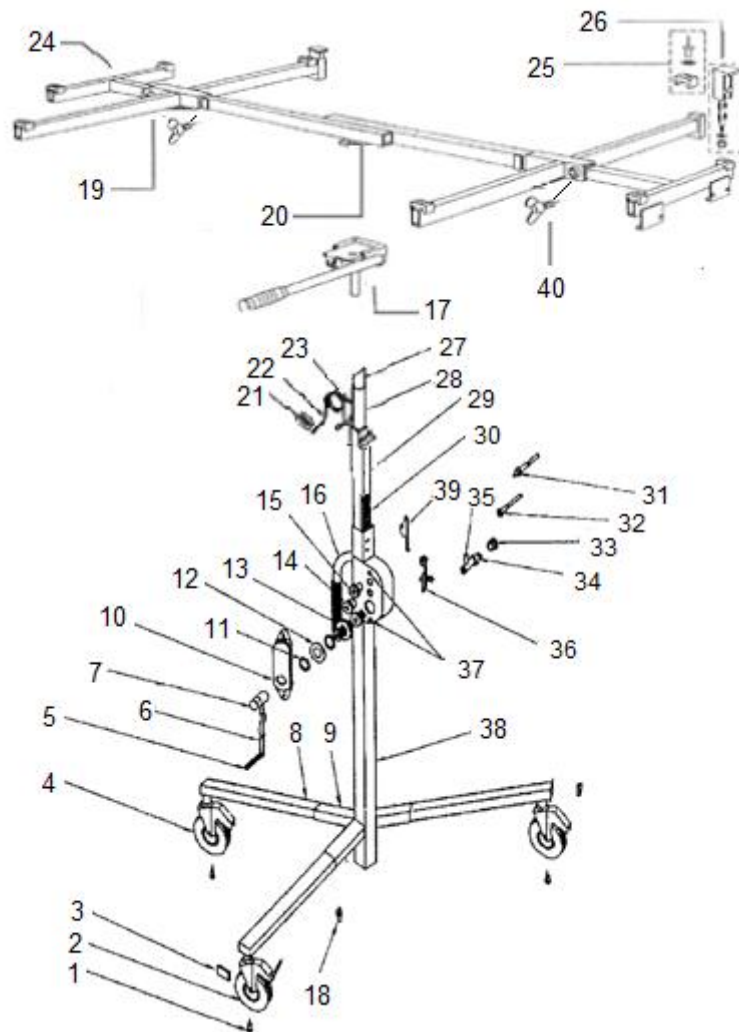

Parts List

Reference	Part Number	Part Description	Quantity
1	1	Hex head screw 12 x 20	3
2	2	Castor with brake	1
3	3	Leg cap	3
4	4	Castor without brake	2
5	5	Rotating crank	1
6	6	Lever	1
7	7	Lever cap	1
8	8	Leg	3
9	9	Leg housing	3
10	10	Box	1
11	11	Clutch plate	2
12	12	Clutch claw	1
13	13	Bush	1
14	14	The middle of gear wheel	1
15	15	The upper of gear wheel	1

Reference	Part Number	Part Description	Quantity
16	16	Handle	1
17	17	Control handle	1
18	18	Anchor	3
19	19	Shelf	2
20	20	Cradle	1
21	21	Ball bearing 34 x 11 x 10	1
22	22	Metal rope 4	1
23	23	Pulley	1
24	24	Side shelf	2
25	25	Rubber support kit	6
26	26	Plastic support kit	2
27	27	Extension third stage	1
28	28	Extension second stage	1
29	29	Extension first stage	1
30	30	Rack	1
31	31	Upper shaft with gear wheel	1
32	32	Middle shaft with gear wheel	1
33	33	Bushing	2
34	34	Shaft	1
35	35	Elastic pin 4x 20	1
36	36	Adjust parts	1
37	37	Hex head screw 6 x 10	2
38	38	Central column	1
39	39	Adjust locking device	1
40	40	Butterfly nut	5

Replacement Parts

- For replacement parts and technical questions, please call Customer Service at **1-800-222-5381**.
- Not all product components are available for replacement. The illustrations provided are a convenient reference to the location and position of parts in the assembly sequence.
- When ordering parts, the following information will be required: item description, item model number, item serial number/item lot date code, and the replacement part reference number.
- The distributor reserves the rights to make design changes and improvements to product lines and manuals without notice.

Limited Warranty

Northern Tool and Equipment Company, Inc. ("We" or "Us") warrants to the original purchaser only ("You" or "Your") that the Strongway product purchased will be free from material defects in both materials and workmanship, normal wear and tear excepted, for a period of one year from date of purchase. The foregoing warranty is valid only if the installation and use of the product is strictly in accordance with product instructions. There are no other warranties, express or implied, including the warranty of merchantability or fitness for a particular purpose. If the product does not comply with this limited warranty, Your sole and exclusive remedy is that We will, at our sole option and within a commercially reasonable time, either replace the product or product component without charge to You or refund the purchase price (less shipping). This limited warranty is not transferable.

Limitations on the Warranty

This limited warranty does not cover: (a) normal wear and tear; (b) damage through abuse, neglect, misuse, or as a result of any accident or in any other manner; (c) damage from misapplication, overloading, or improper installation; (d) improper maintenance and repair; and (e) product alteration in any manner by anyone other than Us, with the sole exception of alterations made pursuant to product instructions and in a workmanlike manner.

Obligations of Purchaser

You must retain Your product purchase receipt to verify date of purchase and that You are the original purchaser. To make a warranty claim, contact Us at 1-800-222-5381, identify the product by make and model number, and follow the claim instructions that will be provided. The product and the purchase receipt must be provided to Us in order to process Your warranty claim. Any returned product that is replaced or refunded by Us becomes our property. You will be responsible for return shipping costs or costs related to Your return visit to a retail store.

Remedy Limits

Product replacement or a refund of the purchase price is Your sole remedy under this limited warranty or any other warranty related to the product. We shall not be liable for: service or labor charges or damage to Your property incurred in removing or replacing the product; any damages, including, without limitation, damages to tangible personal property or personal injury, related to Your improper use, installation, or maintenance of the product or product component; or any indirect, incidental or consequential damages of any kind for any reason.

Assumption of Risk

You acknowledge and agree that any use of the product for any purpose other than the specified use(s) stated in the product instructions is at Your own risk.

Governing Law

This limited warranty gives You specific legal rights, and You also may have other rights which vary from state to state. Some states do not allow limitations or exclusions on implied warranties or incidental or consequential damages, so the above limitations may not apply to You. This limited warranty is governed by the laws of the State of Minnesota, without regard to rules pertaining to conflicts of law. The state courts located in Dakota County, Minnesota shall have exclusive jurisdiction for any disputes relating to this warranty.



Distributed by:

Northern Tool & Equipment Company, Inc.

Burnsville, Minnesota 55306

www.northerntool.com

Made in China