

Installation Instructions for Model 860 AIR RAGE™ AIR TANK & COMPRESSOR

Your purchase of an AIR RAGE Air Tank & Compressor is a perfect choice to power your high-pressure air horns, tools and accessories. The Wolo name, with more than thirty years of experience, is your guarantee of a superior horn product. If you need help installing this product, our technicians are available to answer your questions, Monday through Friday from 9 AM to 4 PM EST by calling 1-888-550-HORN (4676).

IMPORTANT: The compressor comes pre-mounted to the air storage tank. The installer has the option to separate the compressor from the tank and mount it independently.

INDEPENDENT COMPRESSOR / TANK MOUNTING (Fig. 1):

1. If the method of mounting the compressor is to be independent of the tank, remove the four screws that secure the compressor to the tank, then disconnect the braided hose from the tank. You will now be able to separate the compressor from the tank.

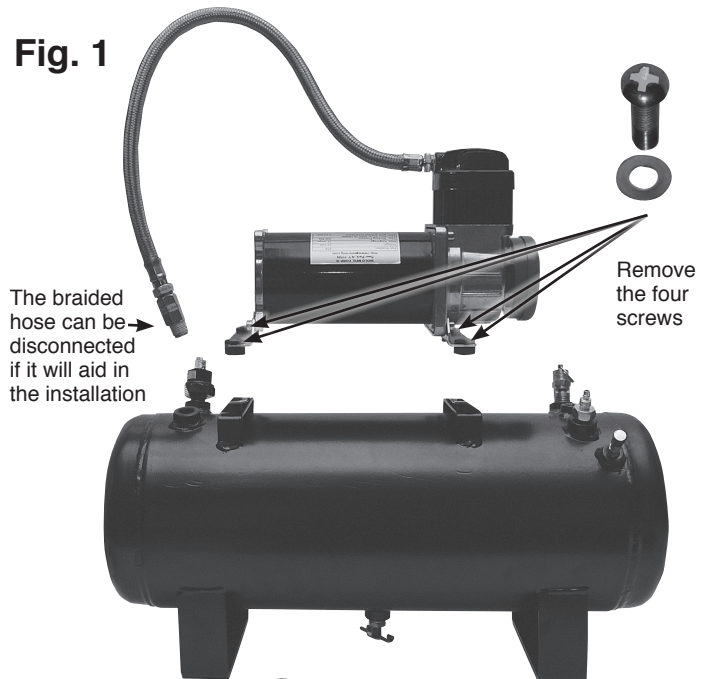

COMPRESSOR and TANK INSTALLATION (Fig. 2):
IMPORTANT! When selecting a mounting location for the compressor, make sure that the compressor's braided hose will be close enough to the tank's inlet connection.

COMPRESSOR INSTALLATION (Fig. 2A):

2. Locate a convenient location to mount the compressor that will be dry. If the location is the engine compartment make sure the compressor is safe from the heat of the exhaust manifold and try to mount compressor as far to the front of vehicle as possible to provide optimum airflow around compressor. **IMPORTANT!** Do not mount on a plastic fender well, or on flexible material.
3. Using the compressor's mounting base as a template, mark the hole locations and drill to size, use a 3/16" drill bit. Secure the compressor to the mounting surface using the hardware provided. (Fig. 2A)

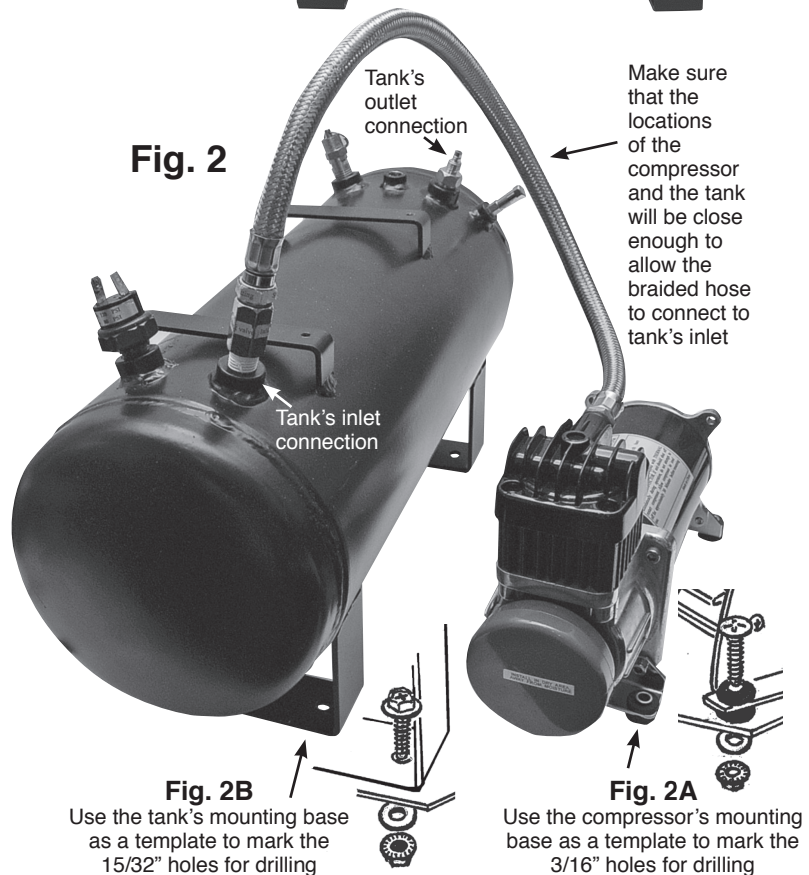

TANK INSTALLATION (Fig. 2B):

4. The mounting location for the tank should be easily reachable so that the tank can be periodically serviced, draining condensation, water from the petcock located on the bottom of the tank.
5. Use the tank's mounting bracket as a template, mark the hole locations and drill to size 15/32". Secure tank with hardware provided.

HOSE INSTALLATION (Fig. 3 and Fig. 4):

6. If the compressor was separated from the tank, connect the stainless steel braided hose from the compressor to tanks inlet port. (Fig. 3.) **IMPORTANT:** Make sure the threaded fitting on the end of the braided hose has either been wrapped with Teflon® tape or coated with pipe sealant to prevent air leaks.
7. Using the high-pressure plastic hose provided, cut to size to be able to connect the tank to inlet fitting of the accessory or valve requiring high-pressure air. Place the brass nut from the tank's outlet fitting onto the high-pressure plastic hose. Push the plastic hose fully onto the outlet fitting, tighten the brass nut onto the outlet fitting. (Fig. 4 and 5)
CAUTION: Do not over tighten the brass nut.
8. The other end of the plastic hose is connected to the accessory or valve requiring high-pressure air.

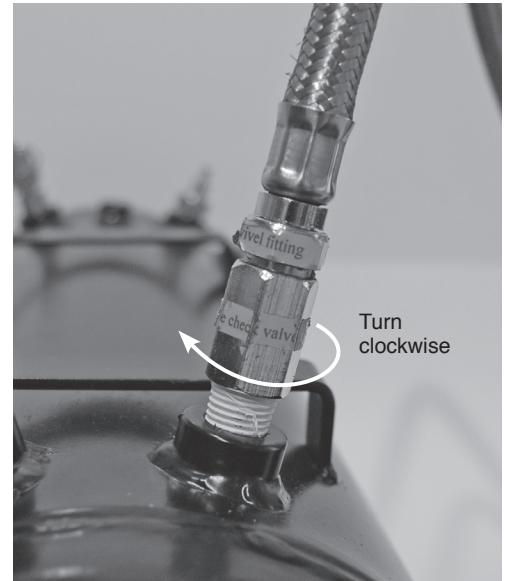

Fig. 3 Connecting the metal braided hose

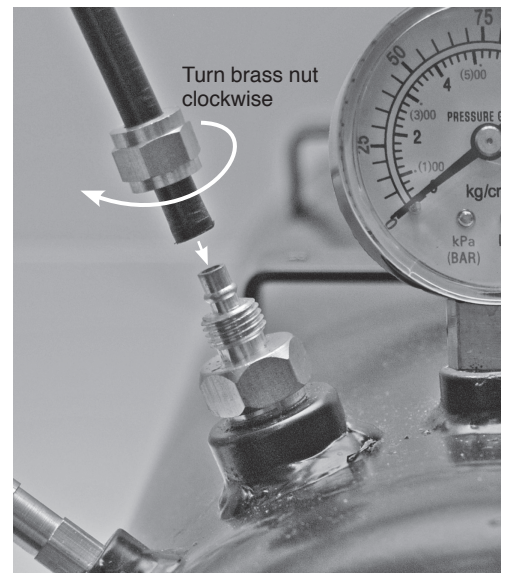
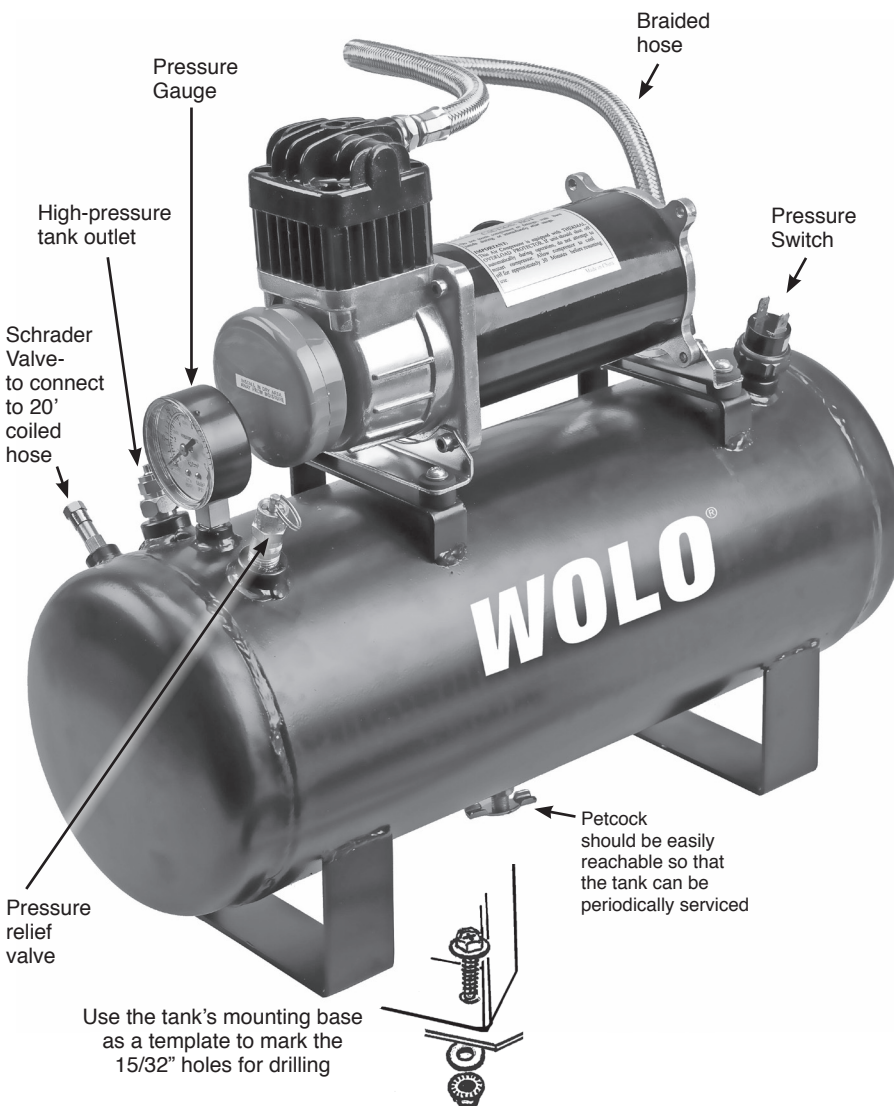

Fig. 4 Connecting the high-pressure plastic hose

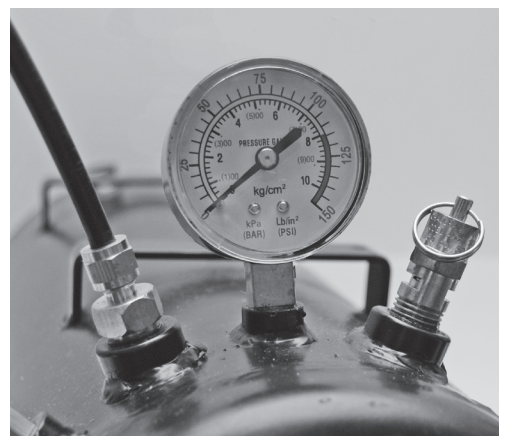

Fig. 5 High-pressure plastic hose connected

WIRING COMPRESSOR (Fig. 7 through Fig. 9):

10. The compressor's red wire is connected to a (+) 12-volt power source, using the fuse provided.

IMPORTANT! The fuse must be connected directly to the power source.

IMPORTANT! The red fused wire must be connected to a (+) 12-volt power source controlled by the vehicle's ignition switch. This will protect your compressor from running continuously and being damaged if an air leak develops when the vehicle is not in operation. Suggested connection points are: blower motor, windshield wiper motor or the accessory terminal on the fuse panel. Make sure the connection point has a wire that is as heavy as the compressor's wires and the connection point is capable of handling 25-amps. **CAUTION:** remove the fuse from the fuse holder until installation is complete.

Fig. 7

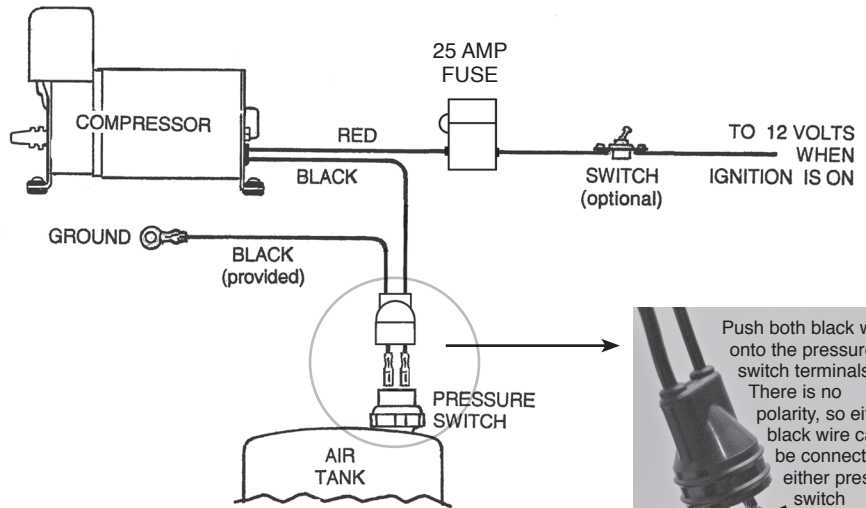

OPTIONAL: A switch can be installed into the compressor's red wire. This will permit the driver to turn-off the system if it is not required. (Fig. 7)

11. The compressor's black wire is connected to a rubber plug. **NOTE:** the rubber plug will have two black wires, both wires will connect to the tank's pressure switch.

IMPORTANT: It is recommended that both black wires be pushed forward so that the terminals are extending out of the rubber boot exposing the 1/4" female terminals (Fig. 8).

12. Select one of the black wires with the 1/4" female terminal, connect the terminal to the pressure switch. Repeat the procedure for the other black wire. **NOTE:** There is no polarity, so either black wire can be connected to either pressure switch terminal (Fig. 8).

13. Push the rubber boot onto the pressure switch (Fig. 9).

14. The black wire with the looped terminal is connected to ground; secure the wire's terminal to either the (-) side of vehicle's battery or under any metal body bolt. Make sure that the ground connection is free of rust and paint. **NOTE:** The compressor is now ready to be used. Install the fuse back into the fuse holder and the compressor will automatically start.

When the pressure drops below 80 PSI in the tank, the pressure switch will automatically turn on the compressor. When the tank pressure is approximately 120 PSI the compressor will automatically turn off. If the compressor does not shut off after 4 minutes of running time, check all air hose connections for leaks. Use soapy water or bubble solution on each fitting, while the compressor is pumping. Use a thread sealant if leak persists after tightening.

CAUTION: Do not touch compressor or fittings with bare hands during or immediately after usage, they will be hot.

IMPORTANT! Compressor is equipped with an internal THERMAL OVERLOAD PROTECTOR. If compressor should shut off before the tank has been filled to the pressure switch's turn off pressure, do not attempt to restart compressor. Allow compressor to cool off for approximately 40 minutes before resuming use.

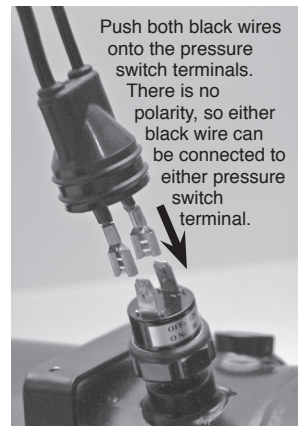

Fig. 8

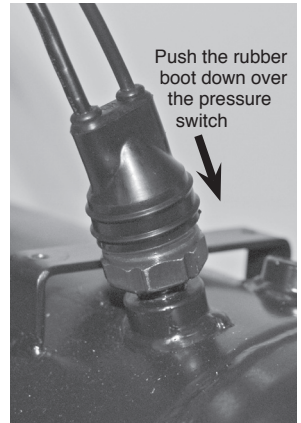

Fig. 9

COMPRESSOR SPECIFICATIONS

12-Volt heavy-duty compressor

Current: 22 amps at peak

CFM: 3.5

In-line fuse holder with 25 amp fuse provided

Permanent magnetic motor that is gearless and thermally protection

Oil-less maintenance free design

High performance piston ring

Moisture & dust resistant

Painted aluminum alloy cylinder

Mounting base has rubber vibration bushings

Stainless steel braided hose with in-line check valve

Washable air filter

Size: L 11-1/2 in. x W 3-1/2 in. x H 6-1/2 in.

TANK SPECIFICATIONS

5-Gallon

Welded steel mounting brackets

Petcock water drain

Pressure switch 80 psi. auto-on / 120 psi. off

Safety pressure relief valve rated at 150 psi.

Pressure gauge

Fitting all brass

Size: L 20-1/2 in. x W 8-1/2 in. x H 17-1/2 in. Compressor mount on tank

Size: L 20-1/2 in. x W 8-1/2 in. x H 10-1/2 in. Tank only.

Warranty

Wolo Manufacturing Corporation ("Wolo") warranties to the original purchaser, for three months from the date of purchase, that this product is free from defects in workmanship and materials. If there is such a proven defect, Wolo, at its option, will either repair or replace the item free of charge, if it is returned to Wolo within three months from the date of purchase together with proof of purchase as described below. Wolo reserves the right to inspect any defect prior to settling any warranty claim by repair or replacement. This warranty is limited as above provided and Wolo will not be responsible for fire or other casualty or accident, due to neglect, abuse, abnormal use, modifications, faulty installation of this product, or natural causes.

ANY EXPRESSED WARRANTY NOT PROVIDED HEREIN IS EXCLUDED AND DISCLAIMED. THE IMPLIED WARRANTIES OF MERCHANTABILITY AND OF FITNESS FOR A PARTICULAR PURPOSE ARE EXPRESSLY LIMITED TO A TERM OF THREE (3) MONTHS. UNDER NO CIRCUMSTANCES SHALL WOLO BE LIABLE TO PURCHASER OR ANY OTHER PERSON FOR ANY SPECIAL OR CONSEQUENTIAL DAMAGES, WHETHER ARISING OUT OF BREACH OF WARRANTY OR OTHERWISE.

To obtain warranty service, return the product prepaid, and include the original bill of sale showing the date of purchase. Provide with the return a brief description of the problem. Also, include with the return a check or money order in the amount of \$20.00 to cover return shipping. Mail to:

Wolo Manufacturing Corp. One Saxwood Street, Deer Park, NY 11729

Attn: Warranty Service E-mail: tech@wolo-mfg.com