

BANNON

Electric Hoist

500-Lb. Capacity

Owner's Manual



! **WARNING:** Read carefully and understand all ASSEMBLY AND OPERATION INSTRUCTIONS before operating. Failure to follow the safety rules and other basic safety precautions may result in serious personal injury.

Item #54290

SAVE THESE INSTRUCTIONS

Thank you very much for choosing a Bannon™ product!

For future reference, please complete the owner's record below:

Serial Number/Lot Date Code: _____

Purchase Date: _____

Save the receipt, warranty, and this manual. It is important that you read the entire manual to become familiar with this product before you begin using it.

This hoist is designed for certain applications only. Northern Tool & Equipment is not responsible for issues arising from modification or improper use of this product such as an application for which it was not designed. We strongly recommend that this product not be modified and/or used for any application other than that for which it was designed.

For technical questions, please call **1-800-222-5381**.

Table of Contents

Intended Use.....	4
Technical Specifications	4
Important Safety Information	4
Specific Operation Warnings	6
Parts Diagram	7
Parts List	7
Assembly Instructions.....	9
Before Each Use.....	10
Operating Instructions.....	11
After Each Use.....	11
Maintenance	12
Troubleshooting.....	13
Replacement Parts	13
Limited Warranty.....	14

Intended Use

The Bannon Electric Hoist operates on standard domestic power. The wire rope comes with a safety-latch weight hook. It operates on a household power source. When the rope touches the limit arm, hoisting is automatically stopped.

Technical Specifications

Property	Specification
Capacity (lb.)	500
Wire Rope (ft.)	95
Voltage (V)	110
Power Cord (ft.)	22.9

Important Safety Information

⚠️WARNING

- Read and understand all instructions. Failure to follow all instructions may result in serious injury or property damage.
- The warnings, cautions, and instructions in this manual cannot cover all possible conditions or situations that could occur. Exercise common sense and caution when using this hoist. Always be aware of the environment and ensure that the tool is used in a safe and responsible manner.
- Do not allow persons to operate or assemble the hoist until they have read this manual and have developed a thorough understanding of how it works.
- Do not modify this hoist in any way. Unauthorized modification may impair the function and/or safety and could affect the life of the product. There are specific applications for which the product was designed.
- Use the right tool for the job. DO NOT attempt to force small equipment to do the work of larger industrial equipment. There are certain applications for which this equipment was designed. It will do the job better and more safely at the capacity for which it was intended. DO NOT use this equipment for a purpose for which it was not intended.
- Industrial or commercial applications must follow OSHA requirements.

⚠️WARNING

- This product contains lead, a chemical known to the State of California to cause cancer and birth defects or other reproductive harm. Wash your hands after handling.

⚠️WARNING

WORK AREA SAFETY

- Inspect the work area before each use. Keep work area clean, dry, free of clutter, and well lit. Cluttered, wet, or dark work areas can result in injury. Using the product in confined work areas may put you dangerously close to other cutting tools and rotating parts.

- Do not use the hoist where there is a risk of causing a fire or an explosion; e.g., in the presence of flammable liquids, gases, or dust. The product can create sparks, which may ignite the flammable liquids, gases, or dust.
- Keep children and bystanders away from the work area while operating the tool. Do not allow children to handle the product.
- Be aware of all power lines, electrical circuits, water pipes, and other mechanical hazards in your work area. Some of these hazards may be hidden from your view and may cause personal injury and/or property damage if contacted.

⚠WARNING

PERSONAL SAFETY

- Stay alert, watch what you are doing, and use common sense when operating the tool. Do not use the tool while you are tired or under the influence of drugs, alcohol, or medication. A moment of inattention while operating the tool may result in serious personal injury.
- Dress properly. Do not wear loose clothing, dangling objects, or jewelry. Keep your hair, clothing and gloves away from moving parts. Loose clothes, jewelry, or long hair can be caught in moving parts. Air vents on the tool often cover moving parts and should be avoided.
- Wear the proper personal protective equipment when necessary. Use ANSI Z87.1 compliant safety goggles (not safety glasses) with side shields, or when needed, a face shield. Use a dust mask in dusty work conditions. Also use non-skid safety shoes, hardhat, gloves, dust collection systems, and hearing protection when appropriate. This applies to all persons in the work area.
- Do not overreach. Keep proper footing and balance at all times.
- Ensure the power switch is off prior to plugging in the tool.
- Secure the work with clamps or a vise instead of your hand when practical. This safety precaution allows for proper tool operation using both hands.

⚠WARNING

ELECTRICAL SAFETY

- Grounded tools must be plugged into an outlet properly installed and grounded in accordance with all codes and ordinances. Never remove the grounding prong or modify the plug in any way. Do not use any adapter plugs. Check with a qualified electrician if you are in doubt as to whether the outlet is properly grounded. If the tools should electrically malfunction or break down, grounding provides a low resistance path to carry electricity away from the user.
- Double insulated tools are equipped with a polarized plug (one blade is wider than the other). This plug will fit in a polarized outlet only one way. If the plug does not fit fully in the outlet, reverse the plug. If it still does not fit, contact a qualified electrician to install a polarized outlet. Do not change the plug in any way. Double insulation eliminates the need for the three wire grounded power cord and grounded power supply system.
- Do not allow the product to come into contact with an electrical source. The tool is not insulated and contact will cause electrical shock.

- Avoid body contact with grounded surfaces such as pipes, radiators, ranges, and refrigerators. There is an increased risk of electric shock if your body is grounded.
- Do not expose power tools to rain or wet conditions. Water entering a power tool will increase the risk of electric shock.
- Do not abuse the power cord. Never use the power cord to carry the tools or pull the plug from an outlet. Keep the power cord away from heat, oil, sharp edges, or moving parts. Replace damaged power cords immediately. Damaged power cords increase the risk of electric shock.

⚠CAUTION

HOIST USE AND CARE

- Do not force the hoist. Products do a better and safer job when used in the manner for which they are designed. Plan your work, and use the correct product for the job.
- Check for damaged parts before each use. Carefully check that the product will operate properly and perform its intended function. Replace damaged or worn parts immediately. Never operate the product with a damaged part.
- Do not use a hoist with a malfunctioning switch. Any power tool that cannot be controlled with the power switch is dangerous and must be repaired by an authorized service representative before using.
- Disconnect the power/air supply from the product and place the switch in the locked or off position before making any adjustments, changing accessories, or storing the tool. Such preventive safety measures reduce the risk of starting the tool accidentally.
- Store the product when it is not in use. Store it in a dry, secure place out of the reach of children. Inspect the tool for good working condition prior to storage and before re-use.
- Use only accessories that are recommended by the manufacturer for use with your product. Accessories that may be suitable for one product may create a risk of injury when used with another tool. Never use an accessory that has a lower operating speed or operating pressure than the tool itself.
- Keep guards in place and in working order. Never operate the product without the guards in place.
- Do not leave the tool running unattended.

Specific Operation Warnings

⚠WARNING

- Improper use can cause risk of fire, electric shock, or serious personal injury.
- Do not lift more than the rated load capacity.
- Do not ride or handle the moving load.
- Not for lifting people or animals.
- Do not work, walk, or stand under an operating hoist.
- Ensure the load is centered below the hoist before use.

- Ensure operator and bystanders are at a safe distance away from hoist and load during operation.
- If you hear an unfamiliar noise, or see vibration in the gears, stop operation immediately.
- Keep water away from the control switches.
- Inspect before use. Ensure the hoist is in working order and the rope is evenly positioned on the drum.
- Ensure the load is balanced on the hook before lifting.
- Ensure the rope is properly attached and centered on the swivel hook.
- If the rope is kinked, distorted, or damaged, stop use and replace immediately.
- After use, ensure the controls are secure and cannot be accidentally engaged.

Not for use by or around children. Store out of reach of children when not in use.

Parts Diagram

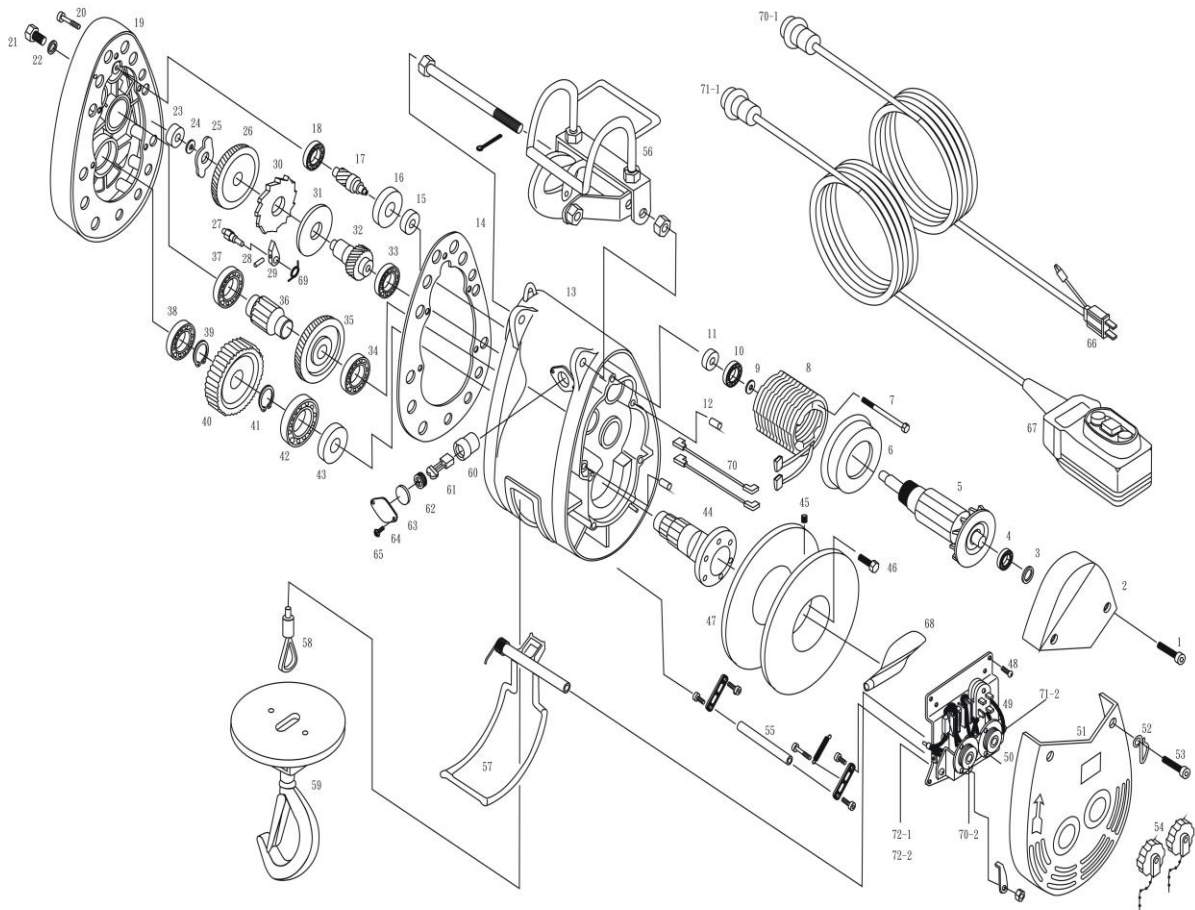

Parts List

Reference	Part Number	Item Description	Qty.
1	54290-01	HEX BOLT	3
2	54290-02	MOTORCOVER	1

Reference	Part Number	Item Description	Qty.
3	54290-03	WASHER	1
4	54290-04	BEARING	1
5	54290-05	ROTOR+1 ST PIONIN	1
6	54290-06	FAN COVER	1
7	54290-07	HEX-BOLT	2
8	54290-08	FIELD COIL ASSY	1
9	54290-09	C RING	1
10	54290-10	BEARING	1
11	54290-11	OIL RING	1
12	54290-12	KNOB PIN	2
13	54290-13	GEAR CASE	1
14	54290-14	PACKING	1
15	54290-15	BEARING	1
16	54290-16	1 ST GEAR	1
17	54290-17	2 ND SHAFT	1
18	54290-18	BEARING	1
19	54290-19	GEAR CASE COVER	1
20	54290-20	HEX BOLT	7
21	54290-21	HEX BOLT	1
22	54290-22	O-RING	1
23	54290-23	BEARING	1
24	54290-24	BUST	1
25	54290-25	1/2 CIRCLE KEY	1
26	54290-26	2 ND GEAR	1
27	54290-27	SET BOLT	1
28	54290-28	SPRING	1
29	54290-29	PAWL	1
30	54290-30	RATCHET	1
31	54290-31	BRAKE DISK	1
32	54290-32	3 RD SHAFT	1
33	54290-33	BEARING	1
34	54290-34	BEARING	1
35	54290-35	3 RD GEAR	1
36	54290-36	4 TH SHAFT	1
37	54290-37	BEARING	1
38	54290-38	BEARING	1
39	54290-39	C RING	1
40	54290-40	4 TH GEAR	1
41	54290-41	C RING	1
42	54290-42	BEARING	1
43	54290-43	OIL RING	1
44	54290-44	OUTPUT SHAFT	1
45	54290-45	P.T. SCREW	1
46	54290-46	HEX BOLT	6
47	54290-47	DRUM	1
48	54290-48	SCREW	4
49	54290-49	CONTROL ASS'Y	1
50	54290-50	PLASTIC PACKING	1
51	54290-51	ELECTRIC COVER	1
52	54290-52	RING	1
53	54290-53	HEX BOLT	4
54	54290-54	CONNECTORS CAP	2
55	54290-55	DOWN LIMIT ARM ASSY	1
56	54290-56	SUPSPENSION HOOK ASSY	1

Reference	Part Number	Item Description	Qty.
57	54290-57	UP LIMIT ARM ASSY	1
58	54290-58	WIRE ROPE ASSY	1
59	54290-59	SWIVEL HOOK	2
60	54290-60	CARBON HOLDER	2
61	54290-61	CARBON BRUSH	2
62	54290-62	BRUSH CAP	2
63	54290-63	O RING	2
64	54290-64	BRUSH COVER	2
65	54290-65	SCREW	4
66	54290-66	POWER CORD ASSY	1
67	54290-67	BUTTON CORD ASSY	1
68	54290-68	ROPE STOPPER	1
69	54290-69	SWITCH RELAY	2
70-1	54290-70-1	POWER CONNECTOR	1
70-2	54290-70-2	POWER CONNECT(ON BODY)	1
71-1	54290-71-1	CONNECTOR PUSH BOTTON(+ MALE 7 PIN)	1
71-2	54290-71-2	CONNECTOR ON BODY (- FEMALE 7 PIN)	1
72-1	54290-72-1	RESISTOR 40W 16Ω	1
72-2	54290-72-2	RESISTOR 30W 20Ω	1

Assembly Instructions

⚠WARNING

Be sure to lock the hanger for extra safety.

Mounting

The hoist is designed to be hung or mounted on a stable bar or bracket. When hanging, do not allow the body or load to be caught on obstructions.

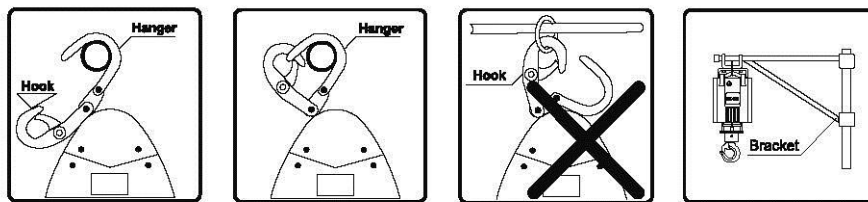

Plug Insertion

Power Cord Insertion

Insert the power plug into the hoist's power receptacle and tighten it by turning the locking ring clockwise. Be sure to lock the cord with a holder. Do not allow the cords to be caught in the wire rope and drum. The standard length of the power cable is 65.62 feet. Use a power cable of 3.5mm to prevent a considerable voltage drop (see figure).

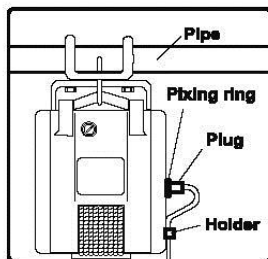

Power Cord Selection

Section	Cord Length
2.0 mm	65.62 feet
3.5 mm	114.83 feet

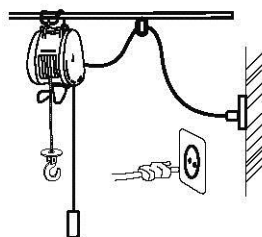

Grounding

To prevent the risk of electric shock, the power plug must be plugged into a matching outlet and grounded in good condition.

Switch Cord Connection

- (1) Insert the switch plug into the switch receptacle of the hoist and tighten it by turning the locking ring clockwise.
- (2) To extend the length of the switch cord, add a switch extension cord (32.81 feet).

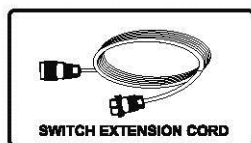

Before Each Use

⚠ WARNING

Be sure to carefully check all safety and environmental conditions.

A minimum of five (5) wraps of wire rope wound around the drum is necessary. A wire rope should be discarded and not be used again if it shows sign of excessive wear. Make sure to connect the main power source and grounding. It's not safe to lift loads exceeding the rated load. Only connect to a power source that is the correct rated voltage otherwise malfunctioning could occur if the input voltage falls above or below 10%.

Operating Instructions

⚠WARNING

Be sure to carefully check all safety and environmental conditions.

Lifting and Lowering Loads

To lift a load, press the ↑ button and the drum will rotate as shown in the following illustrations.

To lower a load, press the ↓ button and the drum will rotate as shown below.

When the button is released, the drum will stop moving.

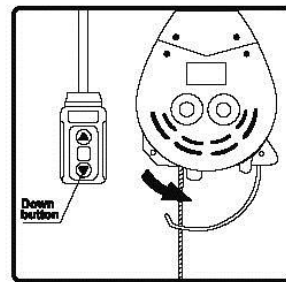
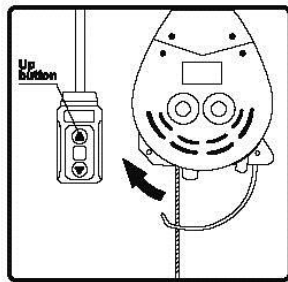

Braking

The brake system is 'on' when the 'up' or 'down' button is 'off'. The machine will completely stop in one minute (maximum) while the rope will keep running with a 1.5% length (maximum).

Owing to the rope speed on no load is faster than that on rated load, the brake distance on no load will be longer, but still within 1.5% of rope length.

The rope speed on no load is 1.5-1.8 times of rated speed on rated load.

Over-Winding Lift Prevention Device

A special mechanism prevents over-winding when lifting. The swivel hook touches the limit distance and lifting is automatically stopped. However, if the limit distance is set too close to the hoist body, it will cause serious damage to the limit distance and the hoist body. A suitable distance is 2.76-3.54 inches between the limit lever and hoist body as below.

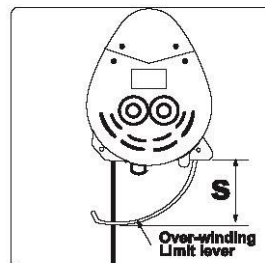

After Each Use

⚠WARNING

Clean the carbon brush periodically to maintain the insulation resistance up to 1MΩ.

It's extremely important to check the carbon brush periodically. It must be replaced when the remaining length is less than 7.5 mm.

To replace, insert the carbon brush into the carbon holder and put the brush cap into the hole. Before tightening the carbon brush holder, make sure to position the O-ring. There are two carbon brushes on opposite sides of hoist body. They both need to be replaced at the same time (see figure).

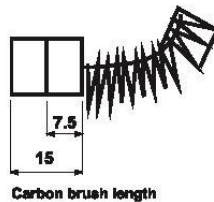
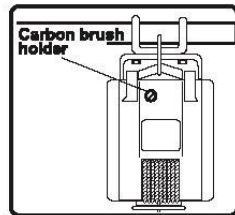

Maintenance

Always turn off the push button switch immediately after use. To avoid potential danger, always make sure you are looking up toward the hoist when operating it. Prior to using, always inspect the hoist for any damages or wear.

Oil Lubrication

The hoist is prefabricated at the factory and does not require initial lubrication. Recommended oil replenishment quantities and intervals are as follows.

Grease Grade	Quantity	Intervals
Caltex Multifak Ep	250 cc	1 Year
Cosmogear SE220		

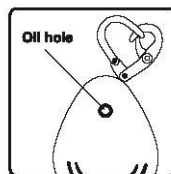

Troubleshooting

The following environmental conditions may cause the hoist to malfunction:

- Temperature below -10°C, temperature above 40°C, or humidity above 90%.
- Heavily acidic or salty conditions. These conditions will cause parts to malfunction.
- Rain or snow will cause the hoist to rust or will create a short circuit.
- Explosive power conditions will cause explosions.
- Heavily powdered conditions will cause the hoist to perform poorly.

Replacement Parts

- For replacement parts and technical questions, please call Customer Service at **1-800-222-5381**.
- Not all product components are available for replacement. The illustrations provided are a convenient reference to the location and position of parts in the assembly sequence.
- When ordering parts, the following will be required: item model number, Item Serial Number/Item Lot Date Code, Item Description, and the replacement part reference number.
- The distributor reserves the rights to make design changes and improvements to product lines and manuals without notice.

Limited Warranty

Northern Tool and Equipment Company, Inc. ("We" or "Us") warrants to the original purchaser only ("You" or "Your") that the Bannon product purchased will be free from material defects in both materials and workmanship, normal wear and tear excepted, for a period of two years from date of purchase. The foregoing warranty is valid only if the installation and use of the product is strictly in accordance with product instructions. There are no other warranties, express or implied, including the warranty of merchantability or fitness for a particular purpose. If the product does not comply with this limited warranty, Your sole and exclusive remedy is that We will, at our sole option and within a commercially reasonable time, either replace the product or product component without charge to You or refund the purchase price (less shipping). This limited warranty is not transferable.

Limitations on the Warranty

This limited warranty does not cover: (a) normal wear and tear; (b) damage through abuse, neglect, misuse, or as a result of any accident or in any other manner; (c) damage from misapplication, overloading, or improper installation; (d) improper maintenance and repair; and (e) product alteration in any manner by anyone other than Us, with the sole exception of alterations made pursuant to product instructions and in a workmanlike manner.

Obligations of Purchaser

You must retain Your product purchase receipt to verify date of purchase and that You are the original purchaser. To make a warranty claim, contact Us at 1-800-222-5381, identify the product by make and model number, and follow the claim instructions that will be provided. The product and the purchase receipt must be provided to Us in order to process Your warranty claim. Any returned product that is replaced or refunded by Us becomes our property. You will be responsible for return shipping costs or costs related to Your return visit to a retail store.

Remedy Limits

Product replacement or a refund of the purchase price is Your sole remedy under this limited warranty or any other warranty related to the product. We shall not be liable for: service or labor charges or damage to Your property incurred in removing or replacing the product; any damages, including, without limitation, damages to tangible personal property or personal injury, related to Your improper use, installation, or maintenance of the product or product component; or any indirect, incidental or consequential damages of any kind for any reason.

Assumption of Risk

You acknowledge and agree that any use of the product for any purpose other than the specified use(s) stated in the product instructions is at Your own risk.

Governing Law

This limited warranty gives You specific legal rights, and You also may have other rights which vary from state to state. Some states do not allow limitations or exclusions on implied warranties or incidental or consequential damages, so the above limitations may not apply to You. This limited warranty is governed by the laws of the State of Minnesota, without regard to rules pertaining to conflicts of law. The state courts located in Dakota County, Minnesota shall have exclusive jurisdiction for any disputes relating to this warranty.

BANNON

Distributed by:

Northern Tool & Equipment Company, Inc.

Burnsville, Minnesota 55306

www.northerntool.com

Made in Taiwan