

GENERAC®

**MOBILE
PRODUCTS**

DRY-PRIME DIESEL TRASH PUMP

MTP4000DZV • MTP4000DZD

MTP6000DZV • MTP6000DZD

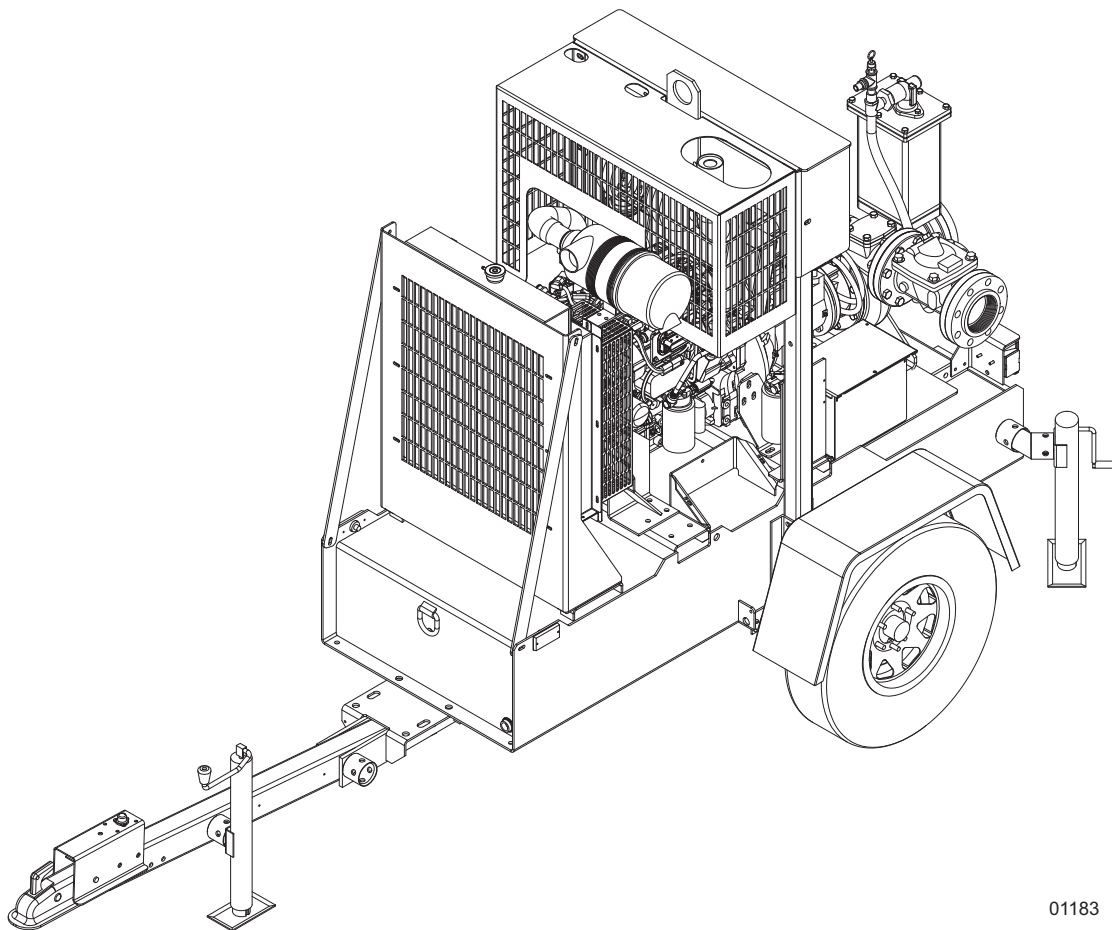

01183

OPERATING MANUAL

Parts manuals available online at www.generacmobile.com

⚠ WARNING

CALIFORNIA PROPOSITION 65 WARNING: Diesel engine exhaust and some of its constituents are known to the state of California to cause cancer, birth defects, and other reproductive harm.

⚠ WARNING

CALIFORNIA PROPOSITION 65 WARNING: This product contains or emits chemicals known to the state of California to cause cancer, birth defects, and other reproductive harm.

Introduction

This manual provides information and procedures to safely operate and maintain the Generac Mobile Products, LLC unit. For your own safety and protection from physical injury, carefully read, understand, and observe the safety instructions described in this manual. Keep a copy of this manual with the unit at all times. Additional copies are available from Generac Mobile Products, LLC, or can be found at www.generacmobile.com. *The information contained in this manual was based on machines in production at the time of publication. Generac Mobile Products, LLC reserves the right to change any portion of this information without notice.*

Read all of the manuals included with the unit. Each manual details specific information regarding items such as setup, use and service requirements. An engine operator's manual provides detailed operation and maintenance procedures for the engine. Additional copies of the engine operator's manual are available from the engine manufacturer.

DO NOT MODIFY or use this equipment for any application other than which it was designed for.

Generac Mobile Products, LLC recommends that a trained and licensed professional perform all electrical wiring and testing functions. Any wiring should be in compliance with the National Electrical Code (NEC), state and local regulations and Occupational Safety and Health Association (OSHA) guidelines.

GENERAC MOBILE PRODUCTS, LLC

215 Power Drive • Berlin, WI 54923

U.S.A.

Phone: 920-361-4442

FAX: 920-361-4416

Toll Free: 1-800-926-9768

www.generacmobile.com

For technical or parts QUESTIONS, please contact the Generac Mobile Products, LLC Customer Support or Technical Support team at 1-800-926-9768. Please have your serial number available.

To ORDER SERVICE PARTS, please contact the dealer from which you purchased the unit, or call Generac Mobile Products, LLC to locate a dealer in your area.

Engine Make: _____

Engine Serial Number: _____

Engine Model Number: _____

Pump Make: _____

Pump Model Number: _____

Pump Serial Number: _____

Unit Model Number: _____

Unit Serial Number: _____

This Page Intentionally Left Blank

Table of Contents

Section 1 - Safety

Safety Notes	1
Operating Safety	1
Engine Safety	2
Pump Safety	2
Service Safety	3
Towing Safety	3
Reporting Trailer Safety Defects	4
Safety Symbol Summary	5

Section 2 - General Information

Specifications	7
Unit Dimensions	8
Unit Serial Number Locations	9
Lowering the Trailer Tongue	9
Component Locations	11
Control Panel	16
Automatic Operation	16
Throttle Control	17
Service Timers	17
CANplus Messenger Telemetry Option	17
Button Lock	17
Control Panel Operation	18
Throttle Control	18
Ramp Throttle (Speed Control Switch)	18
Automatic Start/Stop Operation	19
Start and Stop Events	19
Maintain Functions	20
Dead Band	20
CANplus Display	20
Analog Gauge Pages	21
Digital Gauge Pages	21
Single Analog Gauge	22
Analog Transducer/switch Gauge	22
Digital Transducer Gauge	22
Active Alarms	22
Alarm List	23
Configuration	23
Configuration Menu	23
Display Menu	24
Units Menu	24
Language Menu	25
Button Beep	25
Gauges Menu	25
Max RPM	25
Max Speed	25
Quad Adjust	25
Voltmeter	25
Service Timers	25
System Menu	26
Demo	26
Restore Defaults	26
Com Viewer	27
J1939 Viewer	27
Engine Config	27
J1939 Settings	28
Engine Source	28

Display CAN Add.....	28
Alarm Filter.....	28
SPN Version.....	28
Speed Source.....	28
PIN Settings.....	28
PIN Entry.....	28
PIN Change.....	29
About.....	29
Autostart Menu.....	30
Mode.....	30
Function.....	30
Throttling Menu.....	30
Idle RPM.....	30
Intermediate RPM.....	30
Run RPM.....	30
Ramp Up/Down.....	31
Servo.....	31
Transducer.....	31
Starter.....	32
Settings Menu.....	32
Governor.....	32
CP750 CAN Add.....	32
Calibrate RPM.....	33
Aux Output.....	33
Alarm Settings.....	33
Telemetry Menu.....	33
Telem J1939 Address.....	33
Modbus Address.....	33
Status.....	34
Db Viewer.....	34
Preferred Screen Store.....	34
Pop-up Messages and Alerts.....	34
Service Required.....	34
Data Communications Failure.....	34
Data Not Available.....	35
Adjusting Lighting and Contrast.....	35
Indicators.....	35
Auto Standby LED (Green).....	35
Preheat LED (Amber).....	35
Engine Stop LED (Red).....	35
Warning LED (Amber).....	35
Data Parameters Monitored.....	36
Welding on Equipment with Electronic Controls.....	38

Section 3 - Operation

Pump Set Up.....	39
Pump Pre-use Checkpoints.....	41
Prestart Checklist.....	41
Starting The Unit.....	42
Torsional Vibration.....	44
Diaphragm Pump System.....	44
Operation.....	45
Run-dry Seal.....	45
Liquid Temperature and Overheating.....	45
Pump Vacuum Check.....	45
Bearing Temperature Check.....	46
Stopping the Unit.....	46
Automatic Shutdown.....	46
Emergency Stop switch.....	46
Remote/Auto Starting Option.....	47

Towing the Unit.....	47
Trailer Wheel Bearings	47
Lifting the Unit.....	48

Section 4 - Maintenance

Daily Walk Around Inspection.....	49
General Maintenance	50
Checking the Engine Oil.....	51
Checking the Oil Level Sight Gauge (Diaphragm Pump Only).....	51
Changing the Engine Oil	51
Changing the Oil Filter.....	52
Resetting The CANplus 750 Controller	52
Adjusting The Service Timers	52
Jack Maintenance.....	53
Side-wind Models	53
Top-wind Models	53
Run-dry Seal Maintenance	53
Wear Rings.....	53
Servicing The Pump	53
Pump Disassembly.....	53
Pump Reassembly	55
Impeller Lockscrew Installation.....	56
Lubrication.....	56
Impeller Lockscrew Removal	56
Frame Disassembly and Assembly	57
Disassembly.....	57
Assembly.....	57
Lubrication Instructions.....	58
Mechanical Seal	58
Removing the Mechanical Seal.....	58
Installing the Mechanical Seal.....	59
Priming Chamber.....	60
Float Removal and Installation	60
Reinstallation.....	60
Prime Valve Removal and Reinstallation	60
Float Valve Linkage Removal and Installation	60
Linkage Replacement.....	61
Strainer/Baffle.....	61
Maintenance.....	61
Discharge Check Valve	61
Maintenance.....	61
Disassembly.....	62
Reassembly.....	62
Diaphragm Pump System.....	63
Disassembly.....	63
Reassembly.....	65
Suction Valve Removal and Replacement	65
Actuator Neck Seal Removal and Replacement	66
Crankshaft Removal and Replacement.....	66
Removal:	66
Replacement:	67
Crankshaft Lip Seal Removal and Replacement.....	67
Roller Bearing Removal and Replacement	68
Connecting Rod/Drive Rod Assembly	68
Pedestal Bearing and Seals Removal and Replacement.....	68
Storage.....	68
Extended Storage Preparation	68
Winter Storage.....	69
Restart Preparation	69

Section 5 - Troubleshooting

Pump Troubleshooting	71
Engine Fault Shutdown Troubleshooting.....	72
Control System Troubleshooting	73
Diagnostic Trouble Codes (DTS).....	73
SPN Codes.....	73
FMI Codes.....	74
Section 6 - Wiring Diagrams	
DC Wiring Diagram.....	75
Trailer Lights Wiring Diagram	76
Service Log	77

Section 1 - Safety

SAFETY NOTES



This is the safety alert symbol. It is used to alert you to potential personal injury hazards. Obey all safety messages that follow this symbol to avoid possible injury or death.

This manual contains DANGERS, WARNINGS, CAUTIONS, NOTICES and NOTES which must be followed to prevent the possibility of improper service, damage to the equipment, personal injury or death. The following formatting options will apply when calling the readers attention to the DANGERS, WARNINGS, CAUTIONS, NOTICES and NOTES.

▲ DANGER

INDICATES A HAZARDOUS SITUATION WHICH, IF NOT AVOIDED, WILL RESULT IN DEATH OR SERIOUS INJURY.

▲ WARNING

Indicates a hazardous situation which, if not avoided, could result in death or serious injury.

▲ CAUTION

Indicates a hazardous situation which, if not avoided, could result in minor or moderate injury.

NOTICE

Indicates a hazardous situation which, if not avoided, could result in property or equipment damage.

Note: Notes contain additional information important to a procedure and will be found within the regular text body of this manual.

OPERATING SAFETY



Before using the unit, be sure you read and understand all of the instructions. This equipment was designed for specific applications; **DO NOT** modify or use this equipment for any application other than which it was designed for. Equipment operated improperly or by untrained personnel can be dangerous. Read the operating instructions and familiarize yourself with the location and proper use of all instruments and controls. Inexperienced operators should receive instruction from someone familiar with the equipment before being allowed to operate or set up the unit. The following points should be practiced at all times:

- The area immediately surrounding the unit should be dry, clean, and free of debris.
- Position and operate unit on a firm, level surface.
- **NEVER** start a unit in need of repair.
- **NEVER** modify the unit or use it in a manner other than for what it was designed.
- **DO NOT** start the unit if any panels or guards are loose or missing.
- Turn the key switch to the OFF position when servicing or troubleshooting.
- Use hearing protection if you will be near an operating unit for an extended period of time.
- Keep clear of pump suction and discharge openings while engine is running.
- Keep all body parts, loose clothing and any other obstructions away from moving parts.
- **NEVER** operate a unit while tired, distracted, or under the influence of drugs or alcohol.

ENGINE SAFETY



Internal combustion engines present special hazards during operation and fueling. Failure to follow the safety guidelines described below could result in severe injury or death. Read and follow all safety warnings described in the engine operator's manual. A copy of this manual was supplied with the unit when it was shipped from the factory.

- **DO NOT** run engine indoors or in an area with poor ventilation. Engine exhaust contains carbon monoxide, a deadly, odorless and colorless gas which, if inhaled, can cause nausea, fainting, or death. Only use this unit outside and away from windows, doors, and ventilation equipment.
- **DO NOT** smoke around unit. Ensure that no combustible materials are left on or near unit, as FIRE or EXPLOSION may result.
- **DO NOT** touch or lean against hot exhaust pipes or engine block.
- **DO NOT** clean air filter with gasoline or other types of low flash point solvents.
- **DO NOT** remove engine coolant cap while engine is hot.
- **DO NOT** operate the unit without a functional exhaust system.
- Prolonged exposure to sound levels in excess of 85 dB(A) can cause permanent hearing loss. Wear hearing protection when working around a running engine.
- Keep hands, feet and loose clothing away from moving parts on the engine.
- Keep area around exhaust pipes and air ducts free of debris to reduce the chance of an accidental fire.
- Batteries contain sulfuric acid which can cause severe injury or death. Sulfuric acid can cause eye damage, burn flesh or eat holes in clothing. Protective eye wear and clothing are necessary when working on or around the battery. Always disconnect the negative (-) battery cable from the corresponding terminal before performing any service on the engine or other components.

PUMP SAFETY



Centrifugal pumps are designed for specific applications and may not be suited for other uses without loss of performance or potential damage to equipment/personnel. If there is any doubt about suitability for a specific purpose, contact Generac Mobile Products, LLC for assistance. Follow the safety guidelines described below to prevent hazardous situations which could result in severe injury or death.

- The pump is designed to handle mild industrial corrosives, residues, and slurries containing some large entrained solids. Do not attempt to pump volatile, corrosive, or flammable materials that may damage the pump or endanger personnel as a result of pump failure.
- After the pump has been positioned, make certain that the pump and all hose/piping connections are tight, properly supported and secure before operation.
- **DO NOT** operate the pump without the guards in place over the rotating parts. Exposed rotating parts can catch clothing, fingers, or tools, causing severe injury.
- **DO NOT** remove plates, covers, gauges, pipe plugs, or fittings from an overheated pump. Vapor pressure within the pump can cause parts being disengaged to be ejected with great force. Allow the pump to cool before servicing.
- **DO NOT** operate the pump against a closed discharge valve for long periods of time. If operated against a closed discharge valve, pump components will deteriorate, and the liquid could come to a boil, build pressure, and cause the pump casing to rupture or explode.
- Remove suction and discharge hoses/piping from pump prior to moving. Use lifting and moving equipment with adequate capacity and in good repair.
- **NEVER** exceed the maximum permissible operating pressure of the pump as shown on the pump performance curve.
- **NEVER** wash the unit with a high pressure hose or with any kind of power washer.

- **NEVER** wash the engine block or fuel tank with a power washer or steam cleaner. Water may collect in the pump control panel or other electrical parts, causing damage.
- If equipment is stored more than 12 months, some of the components or lubricants may have exceeded their maximum shelf life. These must be inspected and replaced as necessary prior to pump operation to ensure proper pump performance.

SERVICE SAFETY



All service work must be performed by qualified personnel who are familiar with the equipment. Only a qualified electrician should troubleshoot or repair electrical problems occurring in this equipment. Follow the safety guidelines described below to prevent hazardous situations which could result in severe injury or death.

- Before servicing the unit, make sure the key switch is turned to OFF and the negative terminal on the battery is disconnected. **NEVER** perform even routine service (oil/filter changes, cleaning, etc.) unless all electrical components are shut down.
- **NEVER** service electrical components if clothing or skin is wet. If the unit is stored outside, check the engine for any moisture and dry the unit before use.
- **NEVER** open the radiator cap or oil drain plug while the engine is running or before the engine has cooled down. Pressurized coolant and hot engine oil can cause severe burns. Allow the engine and pump to cool completely before attempting any service work.
- Check the temperature before opening any pump covers, plates or plugs. Allow the pump to cool if overheated.
- Before servicing the pump end, close the suction and discharge valves. Vent the pump slowly and cautiously. Drain the pump completely.
- **NEVER** attempt to modify the engine, pump or related components.
- Replace all guards and safety devices immediately after servicing.
- Replace all missing and hard to read labels. Labels provide important operating instructions and warn of dangers and hazards.
- Make sure slings, chains, hooks, ramps, jacks, and other types of lifting devices are attached securely and have enough weight-bearing capacity to lift or hold the equipment safely. Always remain aware of the position of other people around you when lifting the equipment.

TOWING SAFETY



Towing a trailer requires care. Both the trailer and vehicle must be in good condition and securely fastened to each other to reduce the possibility of an accident. Also, some states require that large trailers be registered and licensed. Contact your local Department of Transportation office to check on license requirements for your particular unit.

- Check that the hitch and coupling on the towing vehicle are rated equal to, or greater than, the trailer's Gross Vehicle Weight Rating (GVWR).
- Check tires on trailer for tread wear, inflation, and condition.
- **NEVER** tow trailer using defective parts. Inspect the hitch and coupling for wear or damage.
- Make sure the trailer hitch and the coupling are compatible. Make sure the coupling is securely fastened to the vehicle.
- Connect safety chains in a crossing pattern under the tongue and **ATTACH THE BREAKAWAY CABLE TO THE REAR BUMPER OF THE TOWING VEHICLE**. Do not attach the cable to the trailer hitch.
- Make sure directional and brake lights on the trailer are connected and working properly.

- Check that lug nuts holding wheels are tight and that none are missing.
- Maximum recommended speed for highway towing is 45 mph (72 km/h). Recommended off-road towing speed is not to exceed 10 mph (16 km/h) or less, depending on terrain.

Before towing the trailer, check that the weight of the trailer is equal across all tires. A large angle between the trailer and tow vehicle will cause more weight to be carried by one axle, which could cause premature wear on the tires and axles and cause potentially unsafe operating conditions.

The trailer is equipped with surge brakes. Check the operation of the brakes by braking the vehicle at a slow speed before entering traffic. Both the trailer and the vehicle should brake smoothly. If the trailer seems to be pushing, check the level in the brake fluid reservoir.

When towing, maintain extra space between vehicles and avoid soft shoulders, curbs and sudden lane changes. If you have not pulled a trailer before, practice turning, stopping and backing up in an area away from heavy traffic.

A film of grease on the coupler will extend coupler life and eliminate squeaking. Wipe the coupler clean and apply fresh grease each time the trailer is towed.

REPORTING TRAILER SAFETY DEFECTS

If you believe your trailer has a defect which could cause a crash or could cause injury or death, you should immediately inform the National Highway Traffic Safety Administration (NHTSA) in addition to notifying Generac Mobile Products, LLC.

If NHTSA receives similar complaints, it may open an investigation; and if it finds that a safety defect exists in a group of vehicles, it may order a recall and remedy campaign. However, NHTSA cannot become involved in an individual problem between you, your dealer, or Generac Mobile Products, LLC.

To contact NHTSA, you may either call the Auto Safety Hotline toll-free at 1-888-327-4236 (TTY:1-800-424-9153), go to <http://www.safercar.gov>; or write to:

Administrator
NHTSA
1200 New Jersey Avenue S.E.
Washington, DC 20590

You can also obtain other information about motor vehicle safety from <http://www.safercar.gov>.

SAFETY SYMBOL SUMMARY

This equipment has been supplied with numerous safety and operating decals. These decals provide important operating instructions and warn of dangers and hazards. Replace any missing or hard-to-read decals and use care when washing or cleaning the unit. Decal placement and part numbers can be found in the online parts manual at www.generacmobile.com. Below is a summary of the intended meanings for the symbols used on the decals.

	Safety alert symbol; used to alert you to potential personal injury hazards.		Remove negative battery cable before performing any service on unit.
	Belt/entanglement hazard; keep body parts clear of this area.		Use clean diesel fuel only.
	Rotating impeller blade hazard; keep body parts clear of this area.		Hearing protection required while operating unit.
	Stop engine before fueling.		Lift here only.
	Fire/explosion hazard; keep open flames away from unit.		Read and understand the supplied operator's manual before operating unit.
	Burn/scald hazard; pressurized steam.		Belt/entanglement hazard; keep body parts clear of this area.
	Hot surface(s) nearby.		Fan hazard; keep body parts clear of this area.
	Asphyxiation hazard; operate in well ventilated area.		Anchor/tie down point.
	Do not remove guard.		Autostart.

01264

This Page Intentionally Left Blank

Section 2 - General Information

SPECIFICATIONS

GENERAC MODEL	MTP4000DZV/DZD	MTP6000DZV/DZD
Engine		
Make/Brand.....	Deutz.....	Deutz
Model.....	D2.9.....	TD2.9
EPA Tier.....	4f.....	4f
Type.....	Natural.....	Turbo
Displacement in ³ (L).....	176.9 (2.9).....	176.9 (2.9)
Cylinders - qty.....	4.....	4
Engine Rated Speed rpm.....	2600.....	2600
Engine Power @ Rated Speed - Intermit. hp (kW).....	48.8 (36.4).....	74.2 (55.4)
Engine Power @ Rated Speed - Cont. hp (kW).....	48.8 (36.4).....	67.0 (50.0)
Engine Operating Speed rpm.....	2600.....	2200
Engine Power @ Operating Speed - Intermit. hp (kW).....	48.8 (36.4).....	72.4 (54.0)
Engine Power @ Operating Speed - Cont. hp (kW).....	48.8 (36.4).....	65.7 (49.0)
Fuel Consumption - 100% load gph (Lph).....	2.93 (11.09).....	3.60 (13.6)
Fuel Consumption - 75% load gph (Lph).....	2.20 (8.33).....	2.70 (10.2)
Fuel Consumption - 50% load gph (Lph).....	1.47 (5.56).....	1.80 (6.8)
Battery Type - Group Number.....	24.....	24
Battery Voltage (quantity per unit).....	12V (1).....	12V (1)
Battery Rating.....	850 CCA.....	850 CCA
Alternator Rating.....	95A.....	95A
Pump		
Make/Brand.....	Cornell.....	Cornell
Model.....	4NNTL.....	6NNT
Fitting Size.....	4" NPTF.....	6" NPTF
Impeller Type.....	2 Vane, Enclosed.....	2 Vane, Enclosed
Impeller Material.....	ASTM A48 Cast Iron.....	ASTM A48 Cast Iron
Impeller Diameter in (mm).....	8.25 (209.6).....	10.09 (256)
Shaft Material.....	Stressproof Steel.....	Stressproof Steel
Volute Material.....	ASTM A48 Cast Iron.....	ASTM A48 Cast Iron
Ring Material.....	ASTM A48 Cast Iron.....	ASTM A48 Cast Iron
Mechanical Seal.....	Tungsten/Silicon-carbide.....	Tungsten/Silicon-carbide
Pump Set (Engine/Pump)		
Maximum Diameter of Solids in (mm).....	3.0 (76.2).....	3.0 (76.2)
Maximum Pump Output gpm (Lpm).....	1450 (5489).....	2750 (10409)
Maximum Lift Suction ft (m).....	28 (8.5).....	28 (8.5)
Maximum Operating Speed rpm.....	2600.....	2200
Total Dynamic Head ft (m).....	165 (50.29).....	150 (45.72)
Sound dB(A) 23 ft @ prime.....	80.....	80
Capacities		
Fuel Tank Volume gal (L).....	110 (416).....	110 (416)
Usable Fuel Volume gal (L).....	95 (360).....	95 (360)
Maximum Run Time hrs.....	32.....	26.4
Weights		
Dry Weight, Skid Mounted lbs (kg).....	2690 (1220).....	2574 (1168)
Operating Weight, Skid Mounted lbs (kg).....	3482 (1572).....	3366 (1527)
Dry Weight, Trailer Mounted lbs (kg).....	3240 (1470).....	3124 (1417)
Operating Weight, Trailer Mounted lbs (kg).....	4032 (1829).....	3916 (1776)
Trailer		
Number of Axles.....	1.....	1
Capacity - Axle Rating lbs (kg).....	5000 (2268).....	5000 (2268)
Tire Size in.....	15.....	15
Brakes - Standard.....	Surge.....	Surge
Hitch - Standard.....	2" Ball.....	2" Ball
Maximum Tire Pressure psi.....	65.....	65

Specifications are subject to change without notice.

UNIT DIMENSIONS

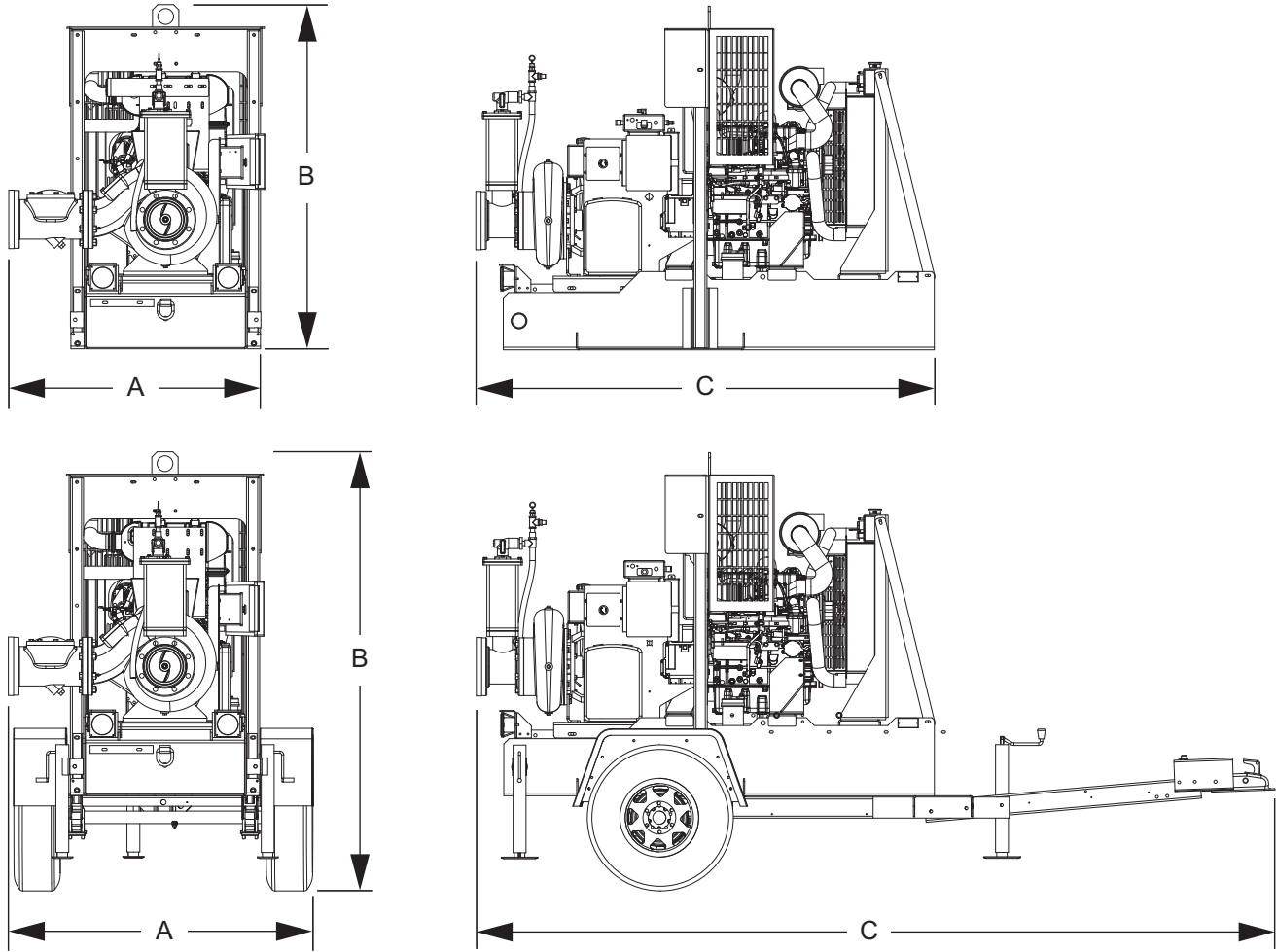

01184

Figure 1 - Unit Dimensions

	A	B	C
MTP4000DZV - Skid Mounted	36 in. (.91 m)	65.38 in. (1.66 m)	83 in. (2.11 m)
MTP4000DZV - Trailer Mounted	57 in. (1.45 m)	83 in. (2.11 m)	148.5 in. (3.77 m)
MTP6000DZV - Skid Mounted	36 in. (0.91 m)	65.38 in. (1.66 m)	88 in. (2.24 m)
MTP6000DZV - Trailer Mounted	57 in. (1.45 m)	83 in. (2.11 m)	153 in. (3.89 m)

Specifications are subject to change without notice.

UNIT SERIAL NUMBER LOCATIONS

Refer to the illustration to locate the unit ID tag and Vehicle Identification Number (VIN) tag on the unit. Important information, such as the unit serial number, model number, VIN and tire loading information are found on these tags. Record the information from these tags so it is available if the tags are lost or damaged. When ordering parts or requesting assistance, you may be asked to provide this information.

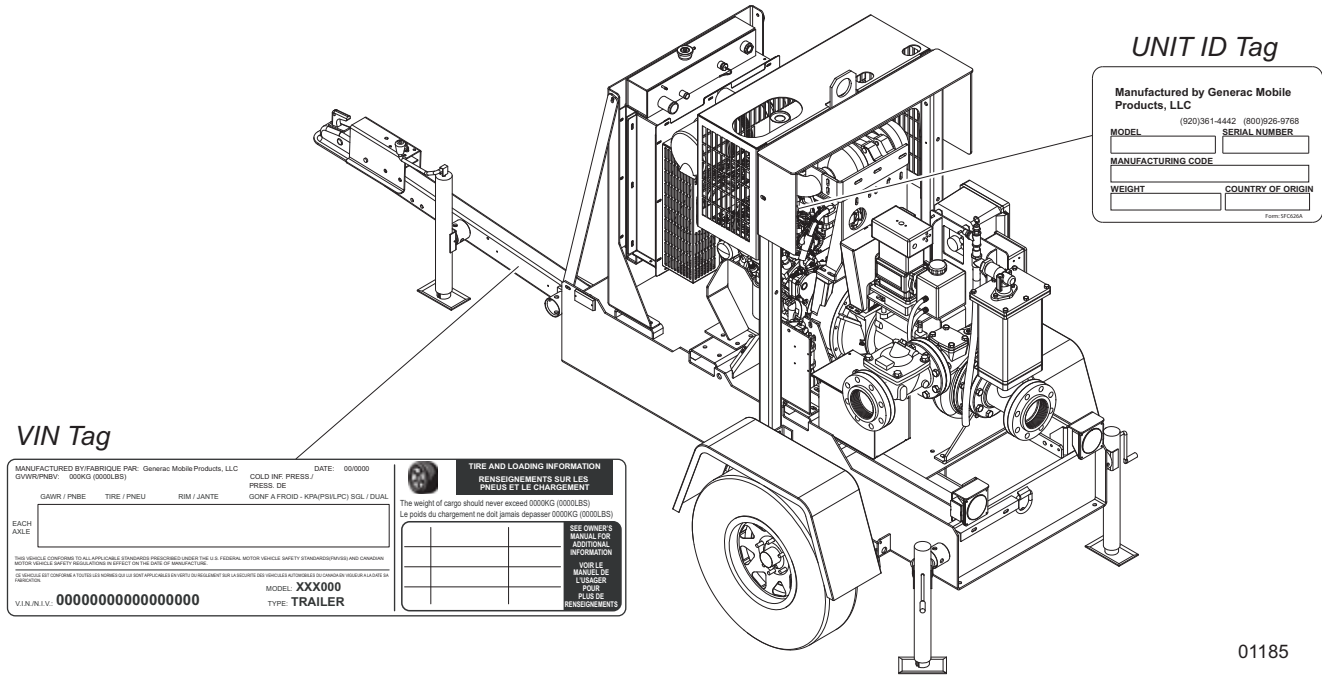

Figure 2 - Serial Number Locations

LOWERING THE TRAILER TONGUE

For units shipped with the trailer tongue in the upright position, follow the steps below to lower the tongue.

1. Elevate the unit using a hoist or forklift, or use the jack located on the trailer tongue.

Note: If using the front jack for support, it must first be moved to the jack mount location nearest the frame.

2. Remove the mounting hardware securing the tongue shipping brace to the trailer frame. Refer to #1 in [Figure 3](#).

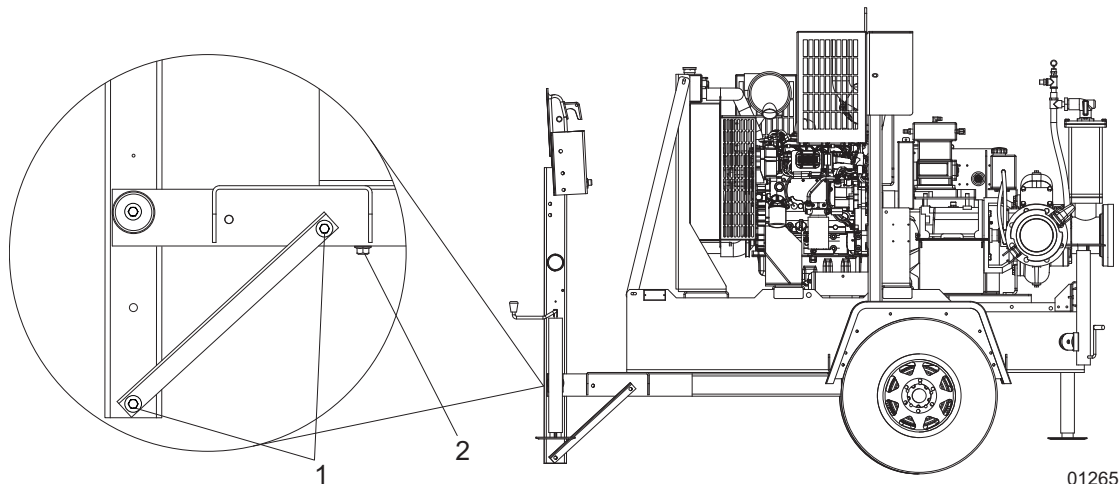

Figure 3 - Removing the Shipping Brace

General Information

3. Remove the shipping brace and slide it into the trailer tube opening. Secure the brace to the trailer with the bolt located on the underside of the trailer and a new nylon locking nut. Refer to #2 in [Figure 3](#).
4. Flip the trailer tongue down and reinstall the bolts and washers removed in step 2 using two new nylon locking nuts. **DO NOT** reuse nylon locking nuts. Tighten the bolts to 80-109 ft-lbs (108-148 Nm).

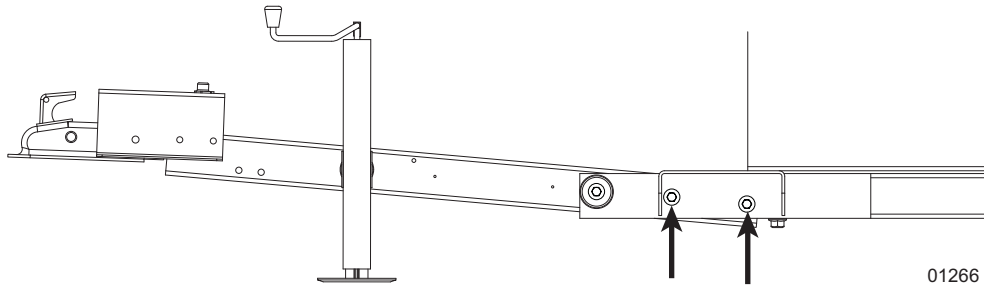
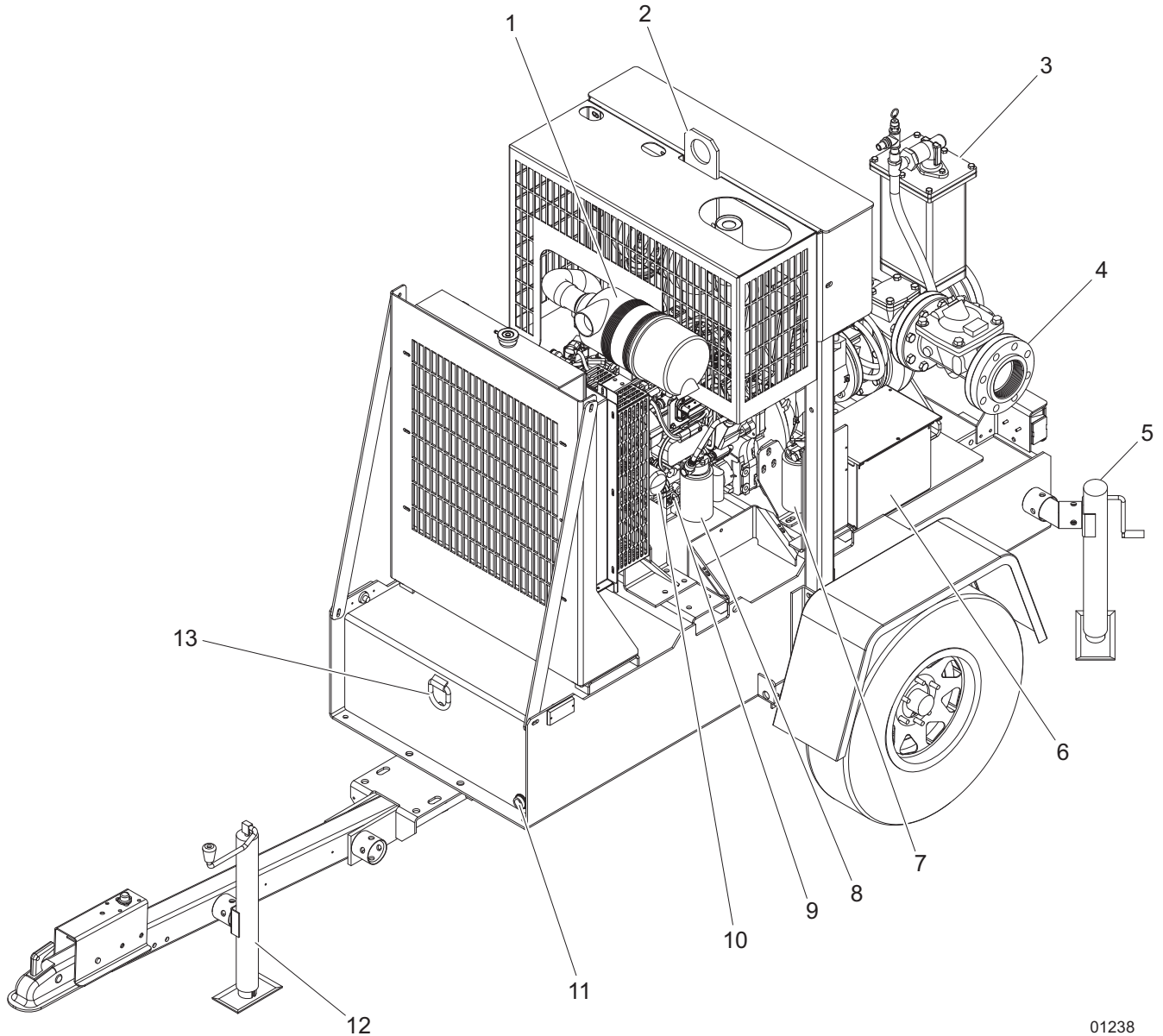

Figure 4 - Reinstall Hardware

Note: If the jack was used to support the unit while removing the shipping brace, the jack must be moved back to the tongue location before the unit can be towed.

1. Connect the trailer tongue to a vehicle or other support and move the jack to the tongue location.
2. Tighten the bolt inside the jack mounting tube nearest the frame.

COMPONENT LOCATIONS



01238

Figure 5 - Left Side (4 Inch Venturi-Prime Pump Shown)

- | | |
|---------------------------------|-------------------------|
| 1. Air cleaner | 8. Fuel filter (main) |
| 2. Central lift point | 9. Dipstick |
| 3. Priming chamber | 10. Oil filter |
| 4. Pump outlet (discharge) port | 11. Fuel tank drain |
| 5. Rear leveling jacks | 12. Front leveling jack |
| 6. Battery | 13. Tie down ring |
| 7. Fuel pre-filter | |

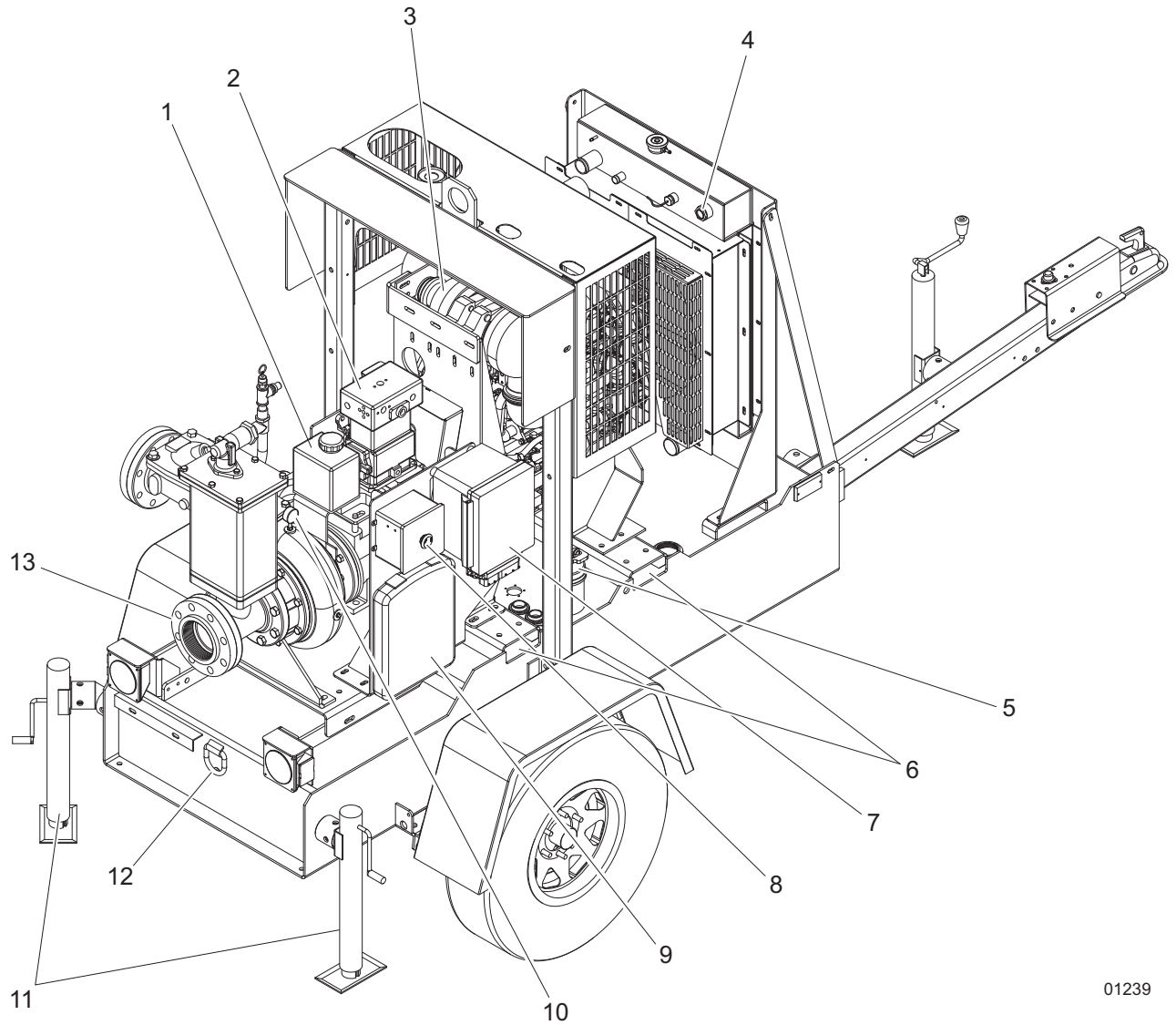

01239

Figure 6 - Right Side (4 Inch Venturi-Prime Pump Shown)

- | | |
|----------------------------------|-------------------------------|
| 1. Mechanical seal oil reservoir | 8. Emergency stop switch |
| 2. Compressor | 9. Manual holder |
| 3. DOC | 10. Vacuum gauge |
| 4. Radiator sight gauge | 11. Rear leveling jacks |
| 5. Fuel fill port | 12. Tie down ring |
| 6. Fork lift pockets | 13. Pump inlet (suction) port |
| 7. Control panel | |

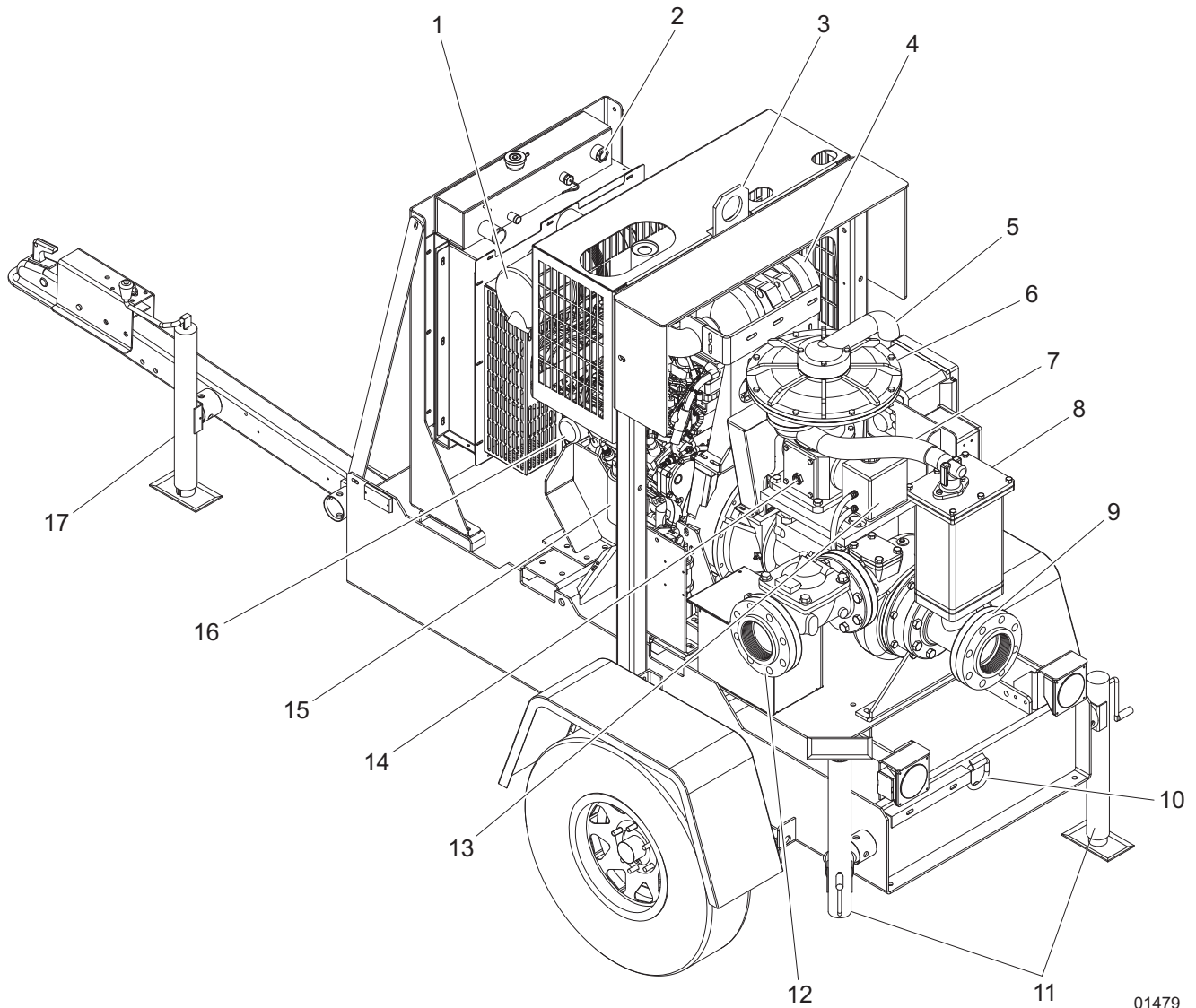

01479

Figure 7 - Left Side (4 Inch Diaphragm Vacuum Pump Shown)

- | | |
|------------------------------|-----------------------------------|
| 1. Air cleaner | 10. Tie down ring |
| 2. Coolant sight gauge | 11. Rear leveling jacks |
| 3. Central lift point | 12. Pump outlet (discharge) port |
| 4. DOC | 13. Mechanical seal oil reservoir |
| 5. Exhaust hose | 14. Sight gauge |
| 6. Diaphragm vacuum pump | 15. Fuel filter (main) |
| 7. Suction hose | 16. Oil filter |
| 8. Priming chamber | 17. Front leveling jack |
| 9. Pump inlet (suction) port | |

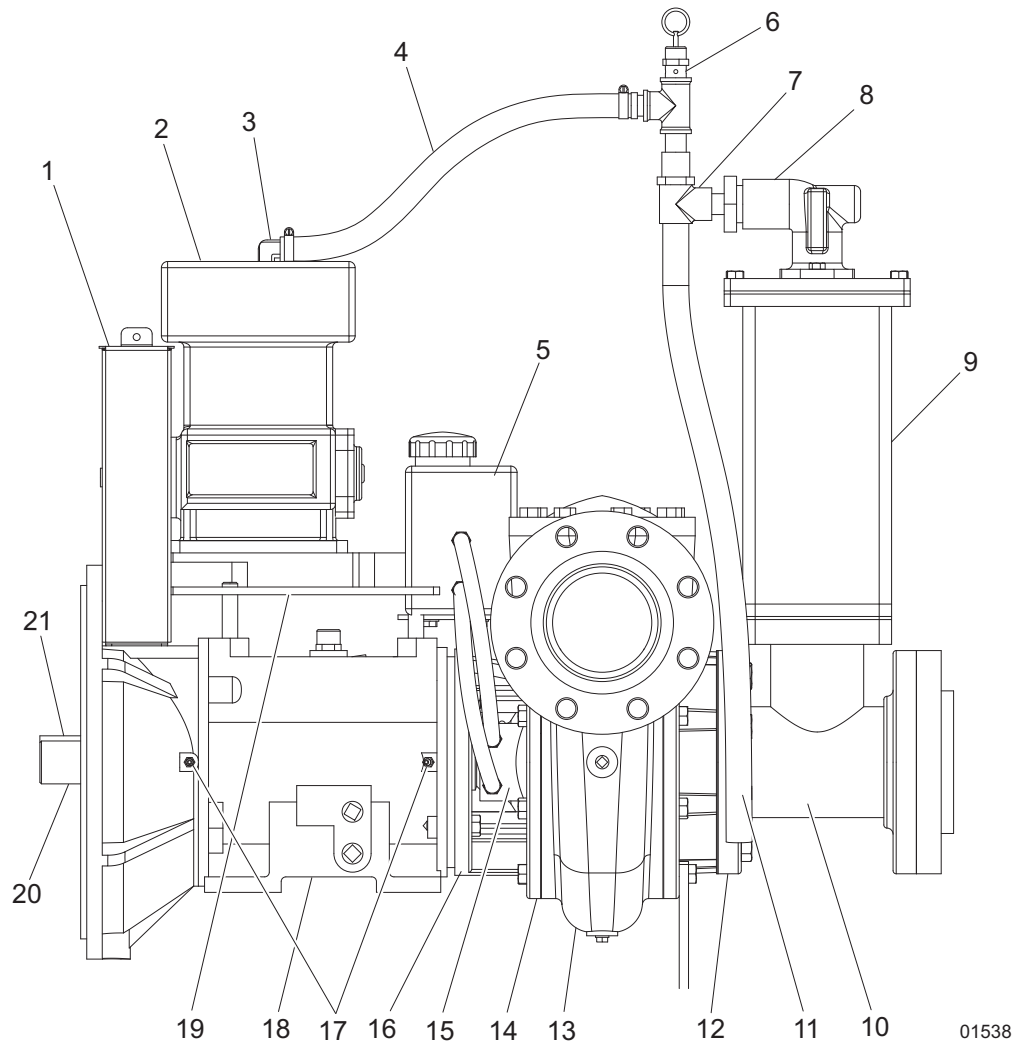

Figure 8 - Venturi-Prime Pump Components - Left Side (4 Inch Shown)

- | | |
|----------------------------------|--------------------------|
| 1. Belt and guard | 12. Suction cover |
| 2. Compressor | 13. Volute |
| 3. Compressor output fitting | 14. Backplate |
| 4. Compressor hose | 15. Run dry gland |
| 5. Mechanical seal oil reservoir | 16. Frame bracket |
| 6. Relief valve | 17. Grease zerk fittings |
| 7. Venturi fitting | 18. Frame |
| 8. Separator hose | 19. Bearing frame |
| 9. Priming chamber | 20. Shaft |
| 10. Suction spool | 21. Drive end shaft key |
| 11. Discharge hose | |

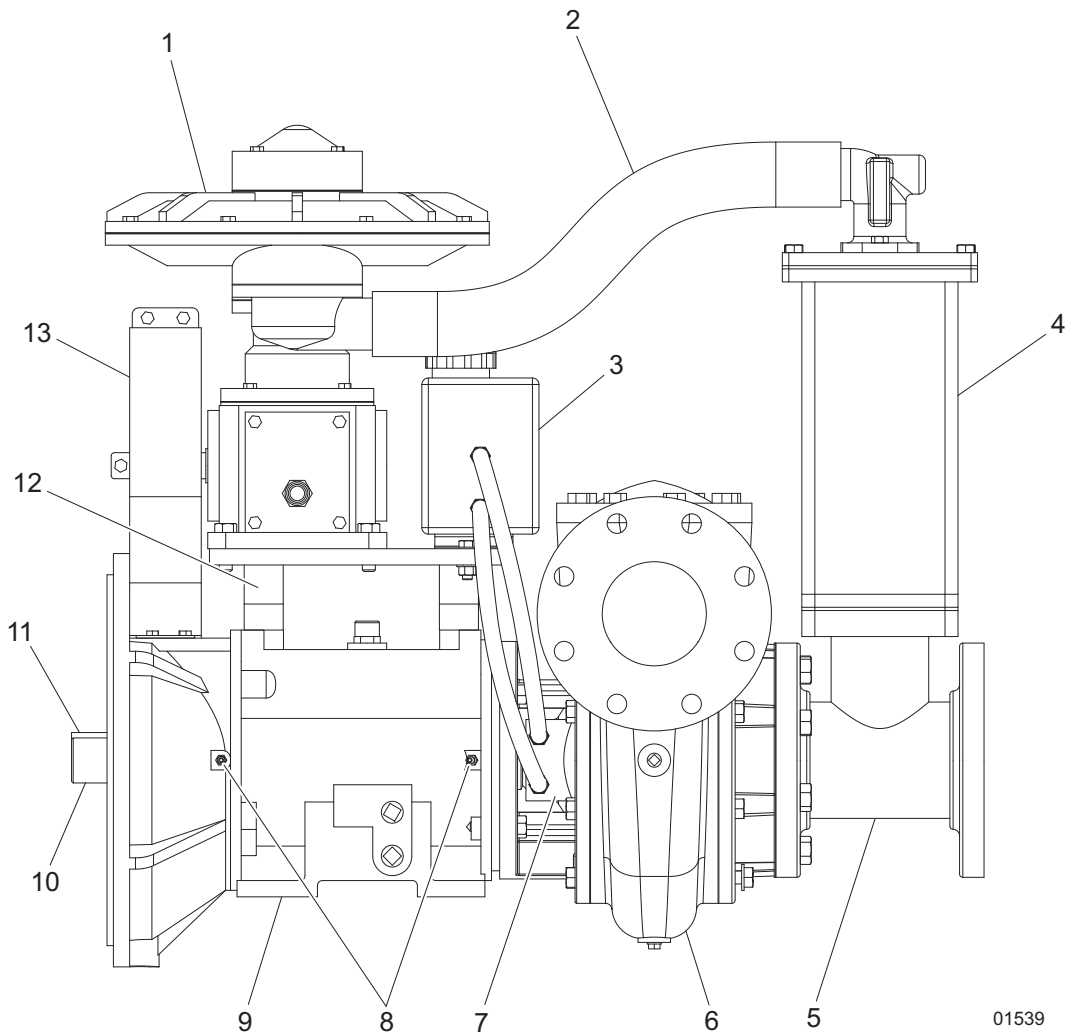

Figure 9 - Diaphragm Vacuum Pump Components - Left Side (4 Inch Shown)

- | | |
|----------------------------------|-------------------------|
| 1. Diaphragm vacuum pump | 8. Grease zerk fittings |
| 2. Priming chamber hose | 9. Frame |
| 3. Mechanical seal oil reservoir | 10. Shaft |
| 4. Priming chamber | 11. Drive end shaft key |
| 5. Suction spool | 12. Spacer |
| 6. Volute | 13. Belt and guard |
| 7. Run dry gland | |

CONTROL PANEL

The CANplus® 750 (CP750™) control panel is a universal platform to monitor, control and automatically start/stop both electronically and mechanically governed diesel engines. The microprocessor-based, solid-state design uses high power semiconductors instead of electromechanical relays to ensure reliable high current switching. Graphical gauge pages or a single large analog gauge are displayed on the 4.25 in. (10.79 cm) diagonal Liquid Crystal Display (LCD). Virtually any SAE J1939 parameter reported by the Engine Control Unit (ECU) can be displayed, including Revolutions Per Minute (RPM), coolant temperature, oil pressure, engine hours, voltage and diagnostic codes. The trans-reflective, backlit display is clearly readable in both bright sunlight and total darkness and is housed in a rugged IP67-rated housing.

Current alarm conditions are displayed in plain language on pop-up messages and can be viewed in the alarm list. Various diagnostic screens allow detailed investigation of the CANbus data stream. By accessing the Configuration menu, users can customize displayed data to show metric or US units, display language and various other parameters such as the full-scale reading of gauges. Four bright Light Emitting Diodes (LEDs) below the display indicate Auto Standby, Preheat, Stop and Warning status.

Five buttons access a context dependent button bar when any button from 1 to 4 is pressed. The graphical menu structure uses icons to indicate the button's current function. After five seconds of inactivity, the button bar disappears.



00337

Button 1	Button 2	Button 3	Button 4	Button 5
<p>Analog Gauge Pages</p> <p>Press repeatedly to cycle through four pages of analog gauges (16 total).</p> <p>00332</p>	<p>Digital Gauge Pages</p> <p>Press repeatedly to cycle through four pages of digital gauges (16 total).</p> <p>00333</p>	<p>Single Analog Gauge</p> <p>Press repeatedly to cycle through available analog gauges.</p> <p>00338</p>	<p>Active Alarm Page</p> <p>Displays active alarms with a plain language description.</p> <p>00339</p>	<p>Gauge Adjust</p> <p>Configures the parameters displayed by gauge pages.</p> <p>00332</p> <p>(Quad Adjust must be enabled.)</p>

Note: Most problems with electronically controlled engines can be pinpointed via ECU diagnostic messages. Use the display or ECU diagnostic tool to view fault codes. Engine state information and diagnostic codes displayed by the CANplus display are provided via the CANbus.

Automatic Operation

The CP750™ panel features advanced automatic start/stop controls which can meet almost any requirement. Two

switch inputs and a transducer input support a number of control scenarios. Single switch mode allows reliable operation with a single switch. Dual switch operation allows greater hysteresis when needed.

The transducer input supports simple start/stop operation by level or pressure and maintenance modes with speed modification.

- Programmable high and low set points control start/stop operation.
- Level maintenance modes monitor the operating point and adjust the engine speed to match the targeted set point with configurable aggressiveness.
- Dual switch inputs can be combined with the transducer input for redundant safety to protect against transducer sensor clog or failure.

Throttle Control

The standard ramp throttle uses a momentary rocker switch to adjust the integral throttle control. All throttle commands are sent directly to the engine using CANbus throttle control.

Service Timers

The CP750™ display provides 16 service timers to alert the operator of needed maintenance. The time interval for each timer can be adjusted in 10 hour increments. A pop-up message is displayed after the display self test if a timer has expired, alerting the user that service is required. The message is displayed on each power up until the elapsed timer is disabled or reset.

CANplus Messenger Telemetry Option

The optional CANplus Messenger system provides a variety of features to protect and support the equipment investment. Remote monitoring can alert maintenance requirements, operational problems, improper operation and location with geo-fence alert. The web-browser interface allows monitoring an entire fleet of equipment in a central location. Contact Generac Mobile Products, LLC for more information.

Button Lock

The control panel's five buttons can be locked so the operator does not accidentally change settings or access another display mode. Button Lock is enabled by pressing and holding buttons 1 and 5 simultaneously for one second. Repeating this operation restores normal button operation.

CONTROL PANEL OPERATION

Turning the key switch to the RUN position energizes the ECU, all LEDs illuminate once and a startup screen is displayed while a self test is performed. If the display beeps for longer than one second, it indicates a self test fault. Users can attempt to rectify the fault by restoring factory defaults. Refer to the Configuration menu for details.

Refer to the Troubleshooting section on [page 7](#) for fault troubleshooting information. Contact Generac Mobile Products, LLC for assistance if the fault persists.

After the startup screen is cleared, the display shows readings on its virtual gauges. Initially the analog gauges are displayed, but the display uses the last displayed screen on subsequent startups. Refer to “Preferred Screen Store” for details.

If the ECU is preheating when the key switch is turned to the RUN position, the Preheat LED is illuminated. Preheat time varies with atmospheric and engine conditions. After waiting for the Preheat LED to extinguish, the engine is cranked by turning and holding the key switch in the START position until the engine starts.

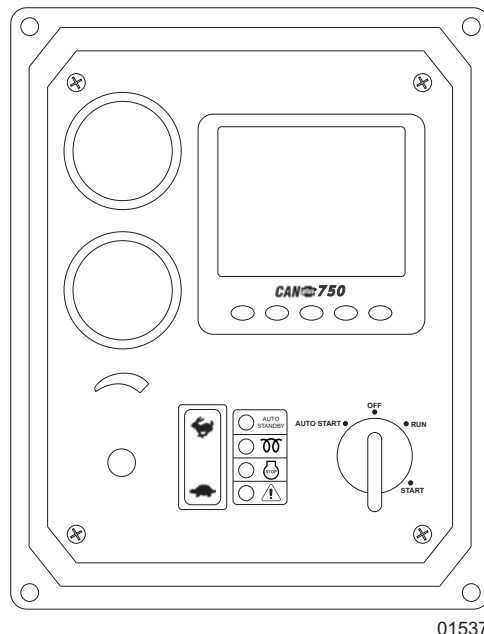

Figure 10 - Control Panel



Note: The ECU will not preheat unless conditions warrant. If necessary, starting the engine may be attempted by turning the key to the START position without waiting for preheat to expire. The key switch is spring loaded to return automatically to the RUN position when released. The key switch includes an interlock to prevent the key from being turned to the START position while the engine is running. The key switch must be turned to the OFF position to reset the starter interlock before the switch can be turned to the START position again.

THROTTLE CONTROL

The type of throttle operators installed, along with the configured values of minimum requested RPM, idle RPM, intermediate RPM, run RPM and maximum requested RPM, determine throttle operation. The engine speed can be adjusted above run RPM and below idle RPM, but the requests can not fall below the set minimum requested RPM or above the set maximum requested RPM. The ECU determines how the engine responds to the throttle requests and will not allow the engine speed to fall below the ECU minimum or exceed the maximum RPM.

Note: To change the minimum requested RPM and maximum requested RPM settings, contact Generac Mobile Products, LLC.

RAMP THROTTLE (SPEED CONTROL SWITCH)

The standard ramp throttle uses a momentary rocker switch to adjust the requested engine speed. When first started, the requested engine speed is Idle RPM. Pressing and releasing the Rabbit  icon increases the speed requested by 25 RPM. Pressing and holding the Rabbit icon causes the speed to accelerate to full speed in a few seconds. Similarly, pressing the Turtle  icon decreases the requested speed.

AUTOMATIC START/STOP OPERATION

The pump can be configured to start automatically by adding dry-contact closure float level switches. Ensure that the dry-contact closure float switch harness is connected to the port on the back of the control box. Contact the Generac Mobile Products, LLC Technical Service Department at 1-800-926-9768 for more information.

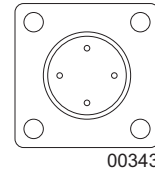

Figure 11 - Dry-contact Port

Turning the key switch to the AUTO START position causes all LEDs to illuminate once the AUTO STANDBY indicator is illuminated and the startup screen is displayed while a self test is performed. After the startup screen is cleared, the display shows the transducer reading and switch status on the Transducer/Switch gauge. All other CANbus values will show **---** since the ECU is not energized at this time. After one minute, the display is powered down to reduce battery drain. The automatic start/stop system is still functioning as indicated by the Auto Standby LED.

For electronically governed units, once the configured automatic start condition exists, the display powers up, the panel starts the engine and follows the throttle control profile configured (refer to [Figure 12](#)). The flexible throttle profile includes various speeds and times for a variety of scenarios.

When the configured stop conditions exist, the panel reduces the engine speed per the throttle profile and stops the engine. If the configured start conditions exist before the shutdown process is complete, the engine will return to the previous speed until the stop condition exists.

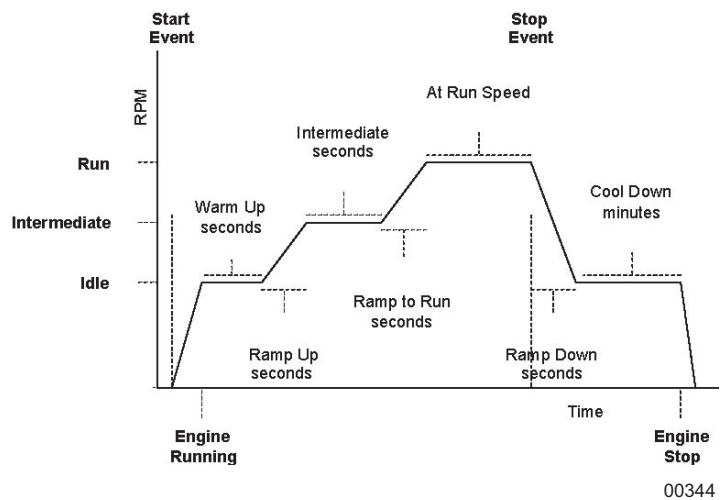

Figure 12 - Throttle Control Profile

⚠ WARNING

When the key switch is turned to the AUTO START position and a start condition exists, the panel will start immediately. Always configure parameters by turning the key switch to the RUN position. DO NOT configure the panel in the AUTO START position. Always use lock out/tag out procedures when servicing autostart equipment.

Start and Stop Events

The start and stop events are determined by the combination of Start/Stop mode and function.

Start/Stop Modes:

Sngl Switch Switch one controls automatic operation.

Dual Switch Both switch inputs control automatic operation.

Transducer The transducer input controls automatic operation.

Xducer & Sw The transducer input controls automatic operation with dual switch mode as the backup. The switch inputs override the transducer if actuated when the transducer is not calling for an automatic cycle.

Start/Stop Functions:

Empty Uses the selected mode to *reduce* the level or pressure.

General Information

- Fill** Uses the selected mode to *increase* the level or pressure.
- Maintain Out** Uses the transducer to maintain the level or pressure at or *below* the target.
- Maintain In** Uses the transducer to maintain the level or pressure at or *above* the target.

Mode ▼	Function ►	Empty	Fill	Maintain Out	Maintain In
Sngl Switch	Start	SW1 Close	SW1 Open	SW1 Close	SW1 Open
	Stop	SW1 Open	SW1 Close	SW1 Open	SW1 Close
Dual Switch	Start	SW1 and SW2 Close	SW1 and SW2 Open	SW1 and SW2 Close	SW1 and SW2 Open
	Stop	SW1 and SW2 Open	SW1 and SW2 Close	SW1 and SW2 Open	SW1 and SW2 Close
Transducer	Start	Above High Set Point	Below Low Set Point	Above High Set Point	Below Low Set Point
	Stop	Below Low Set Point	Above High Set Point	Below Low Set Point	Above High Set Point
Xducer & Sw	Start	Above High Set Point or SW1 and SW2 Close	Below Low Set Point or SW1 and SW2 Open	Above High Set Point or SW1 and SW2 Close	Below Low Set Point or SW1 and SW2 Open
	Stop	Below Low Set Point or SW1 and SW2 Open	Above High Set Point or SW1 and SW2 Close	Above High Set Point or SW1 and SW2 Close	Below Low Set Point or SW1 and SW2 Open

Note: When the switch inputs are the source of the start event in Xducer & Sw mode, only the switches will stop the engine.

Maintain Functions

The Maintain In and Maintain Out functions adjust the engine speed to keep the transducer level at the Target Set Point. The Servo Gain adjusts how aggressively the throttle is adjusted while the Servo Delay controls how often the throttle is adjusted.

Note: Maintain functions are only available in the Transducer or Xducer & Sw modes.

The direction of the throttle adjustment is dependent on the selected mode as shown in the table.

Transducer State	Maintain Out	Maintain In
Above Target	Increase Speed	Decrease Speed
Below Target	Decrease Speed	Increase Speed

Dead Band

In some situations, the transducer level may fluctuate around the Target Set Point. To limit throttle hunting using the maintain functions, a dead band can be programmed. This value prevents throttle adjustment while the level is within the band (refer to diagram). In essence, the speed is considered to be at the target whenever it is within the dead band.

Note: The dead band entered is the amount above and below the target point. For example, if the target is 5.0 ft (1.52 m) with a 0.1 ft (.03 m) dead band, the dead band is 4.9 to 5.1 ft (1.49 to 1.55 m).

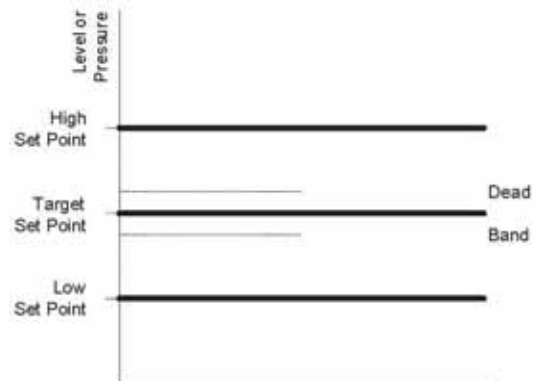

00345

CANPLUS DISPLAY

Soft buttons simplify the user interface by displaying a *button bar* above the buttons when any of the first four buttons (buttons 1 to 4), starting from the left) are pressed. Icons on the button bar change to represent the current function

of each button. The button bar disappears after five seconds if no further buttons are pressed.

Note: Different software versions may have slightly different displays.

ANALOG GAUGE PAGES

Analog Gauge Pages provide four independent pages of analog gauges. To enable Analog Gauge Pages, press any of the first four buttons to show the top level button bar and then press button 1 . Alternate pages are selected by repeated pressing of button 1. The four standard gauge pages are shown below.

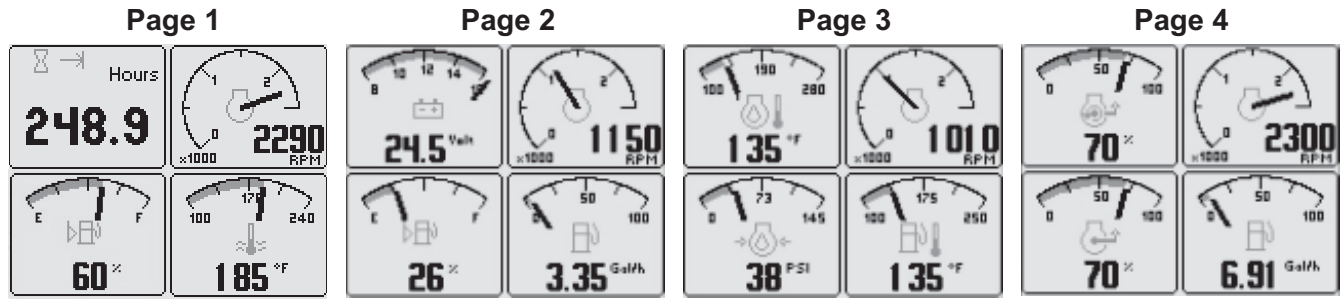





00331

Note: Engine Hours are displayed as a digital value even on Analog Gauge Pages. The default gauge pages represent 13 selections since the tachometer is repeated in the upper right quadrant of each page.

All 16 gauges may be configured by the user to create an application-specific view of CANbus data. Gauges on the current page can be changed via Adjust mode, accessed by pressing button 5  when the button bar is visible. Gauges can be changed on any of the four pages by selecting the page to be changed and then entering Adjust mode.

Note: Quad Adjust must be enabled to access the Adjust mode.

In Adjust mode, a new button bar is displayed identifying the button functions. Button 1  corresponds to the upper left gauge, button 2  to the upper right gauge, button 3  to the bottom left gauge and button 4  to the bottom right gauge. Successive presses of the buttons selects a different parameter for the gauge. Adjust mode is exited by pressing button 5  and storing the new configuration even when power is removed.

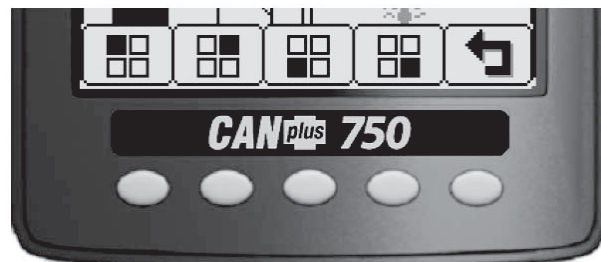

00342

Note: A gauge selection can only appear once per page. To move a gauge selection, the existing gauge location must be changed first. Gauge selections are limited to the data currently being received. Analog Gauge Pages can be configured in Demo mode to select any supported parameter. Refer to Data Parameters Monitored for a complete list of available parameters.

Adjust mode can be disabled in the Configuration menu (Quad Adjust - Off) to prevent accidental changes.

DIGITAL GAUGE PAGES

Digital Gauge Pages display the same data as the Analog Gauge Pages but in digital only format. To enable Digital Gauge Pages, press any of the first four buttons to show the top level button bar and then press button 2 . Alternate pages are selected by repeated pressing of button 2. The four standard Digital Gauge Pages are shown

below.

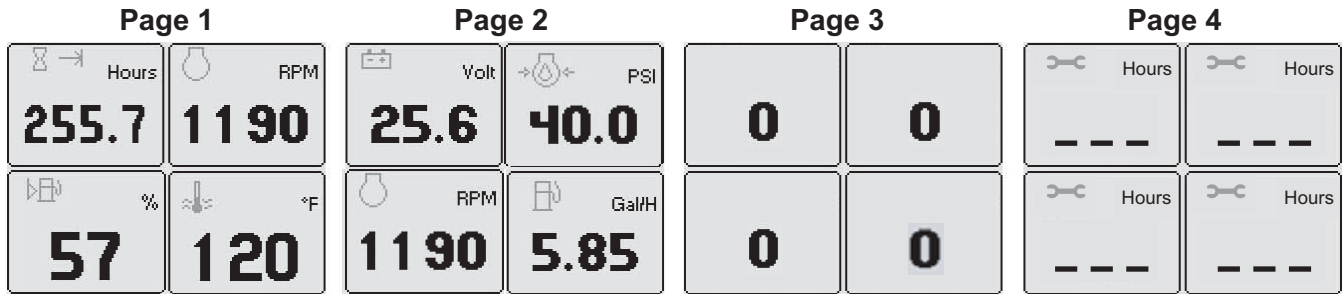

00346

Note: The 16 gauges are the same for Analog and Digital Gauge Pages. Adjustments in either Analog Gauge Pages or Digital Gauge Pages affect the same gauge in the other mode.

SINGLE ANALOG GAUGE

Single Analog Gauge uses the entire display for a single large analog gauge. This mode is enabled by pressing any of the first four buttons to show the top level button bar and then press button 3. The gauge displayed is selectable by repeatedly pressing button 3 while in the Single Analog Gauge mode while the menu bar is visible. The currently displayed gauge is stored when power is removed. Refer to *Preferred Screen Store*.

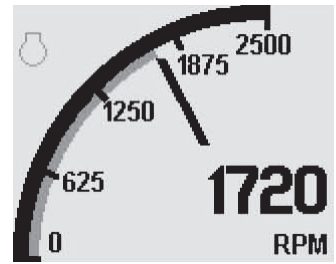

00347

Note: Gauge selections are limited to the data currently being received. Refer to *Data Parameters Monitored* for a complete list of available parameters.

ANALOG TRANSDUCER/SWITCH GAUGE

The Analog Transducer/Switch Gauge displays the transducer value and the switch input states. The left column represents the values as a bar graph with a digital value displayed below. The right column shows whether the switches are open, represented by the pointer being down, or closed, represented by the pointer being up.

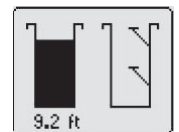

00348

DIGITAL TRANSDUCER GAUGE

The Digital Transducer Gauge displays the transducer value as a digital only value. The switch state is not displayed on the Digital Transducer Gauge.

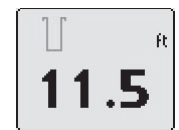

00349

ACTIVE ALARMS

A flashing pop-up window is overlaid on the current screen when an active alarm is received. The pop-up includes a plain language description in addition to the standard SPN/FMI (Suspect Parameter Number/Failure Mode Indicator) pair defined by the SAE J1939 standard. Additionally, if enabled, the beeper sounds as an audible cue.

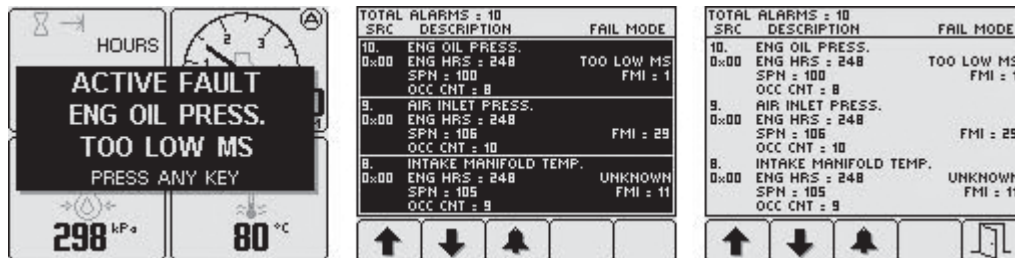

00350





In the examples above are alarm list screens showing unacknowledged conditions and acknowledged alarms. After

acknowledgment, the exit button  becomes active.

Note: Standard J1939 abbreviations are used for alarms. MS = Most Severe, MOD= Moderately Severe, LS = Least Severe.

Refer to “*Diagnostic Trouble Codes (DTS)*” on page 73 for more information on SPN/FMI codes.

ALARM LIST

The Alarm List is accessed by pressing any button while an alarm pop-up is displayed or by pressing any of the first four buttons to show the button bar and then button 4 . Alarms not yet acknowledged are shown in gray on black while acknowledged alarms are shown in black on gray. The list also indicates when the alarm occurred if engine hours are available. The most recent alarm is displayed at the top of the list. The list can be scrolled using buttons 1  and 2  and alarms acknowledged by pressing button 3 . The Alarm List can be closed by pressing button 5  once the alarms are acknowledged.





An alarm indicator  is displayed near the upper right corner of the display as long as alarms are active. The indicator and alarm messages in the list are automatically removed when the alarm is no longer received for a few seconds.

Note: Only active faults are displayed in the alarm list. Once a fault is corrected, it is automatically removed from the list. To view previously active faults, use the engine diagnostic tool.

CONFIGURATION

To adapt the CP750™ panel to the requirements of a particular application, a large number of parameters are configurable. The most commonly modified parameters can be accessed by invoking the Configuration menu of the display. Infrequently changed parameters and those parameters that typically need to be restricted, such as Maximum RPM, are accessible only through the CANplus Configuration. The CANplus Configurator is a Windows® PC program and a hardware adapter that allows total access to the parameters of the panel. For more information about the CANplus Configurator, please contact Generac Mobile Products, LLC.

CONFIGURATION MENU

The Configuration menu allows the user to set various operating parameters such as US or Metric units, scale limits for tachometer and service timers. The Configuration menu is entered by pressing and holding button 5 (the right hand button) in any mode for at least three seconds. If PIN (Personal Identification Number or ‘password’) entry is enabled the correct PIN must be entered to access the Configuration menu. The top level Configuration menu is displayed as shown. Buttons 1  and 2  allow you to choose from Display, System, Autostart, Settings, Telemetry or Db Viewer. Pressing button 4  selects the chosen menu item indicated by bold text and the selection arrow . Each item is described in detail on the following pages. Settings are automatically stored when exiting the current

menu even when power is removed.

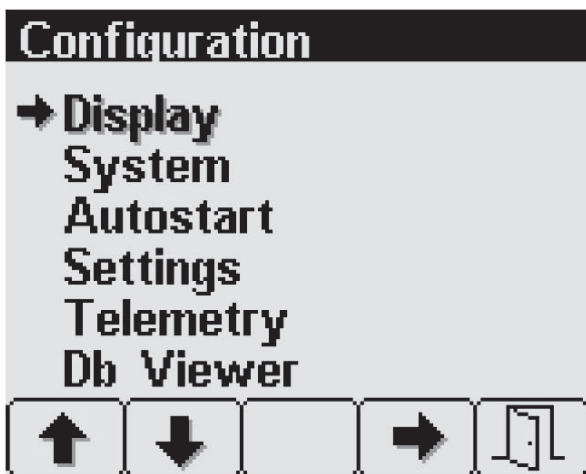

The top level Configuration menu and its six choices.

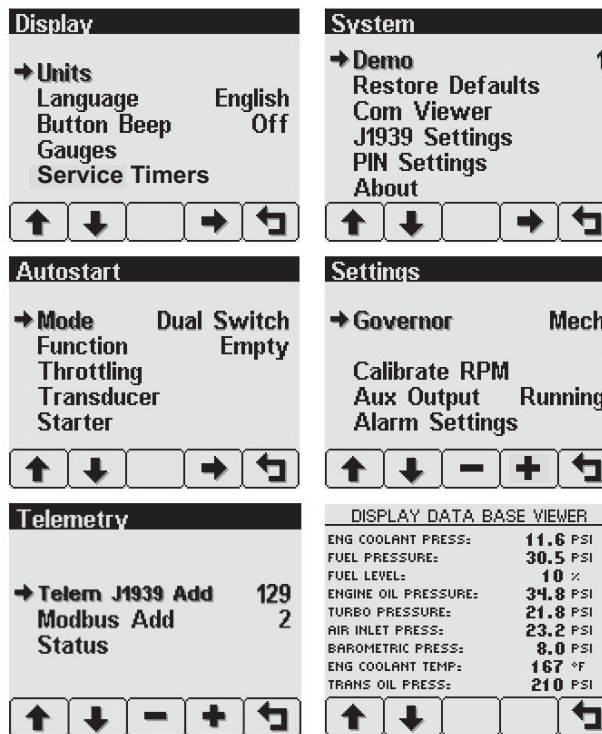

00351

Note: Most configuration changes take affect immediately. Some, such as Idle RPM, take effect on the next power up.

DISPLAY MENU

The Display menu allows the user to configure items affecting how information is displayed.

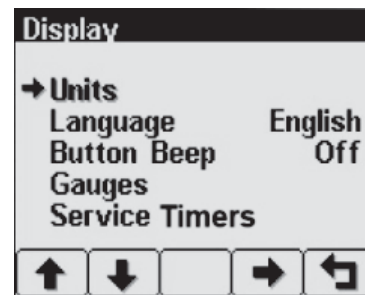

00352

Units Menu

This menu allows the user to set the units used for speed, distance, pressure, volume and temperature independently. Button 4 (→) cycles through the available values for the selected item.

- Speed** MPH (miles per hour); km/h (kilometers per hour); Knts (knots)
- Distance** Miles; km (kilometers); NM (nautical miles)
- Pressure** PSI (pounds per square inch); bar (barometric units); kPa (kilopascals)
- Volume** Gal (US gallons); IGal (Imperial gallons); Liters
- Temperature** °F (Fahrenheit); °C (Celsius)

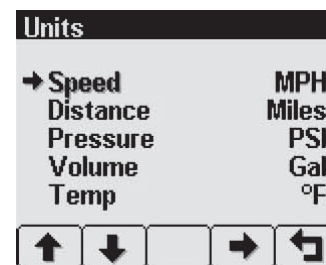

00353

Language Menu

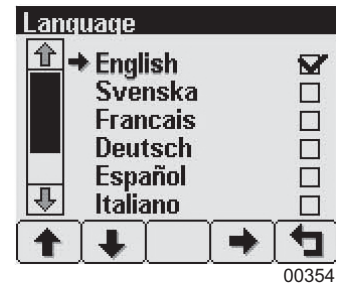

This menu allows the user to choose between English, Swedish, French, German, Spanish, Italian, Dutch and Portuguese. The currently selected value is indicated by the check mark . Button 4  selects the highlighted value.



Button Beep

The soft buttons emit an audible beep when this item is On. Button beep is disabled by setting this item to Off. The audible beep still sounds when an alarm occurs. Button 4  cycles between On and Off.

Gauges Menu

This menu allows the user to configure aspects of the gauges displayed. Button 3  selects the previous value while button 4  selects the next value of the highlighted item.

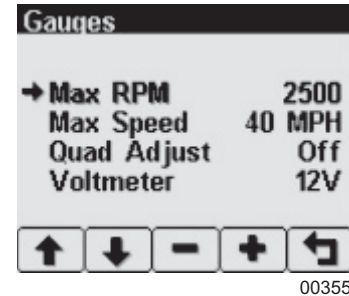

Max RPM

Sets the full scale RPM indicated by the tachometer gauge.

RPM 2500, 3000, 3500, 4000, 4500, 5000, 6000, 7000, 8000 or 9000



Max Speed

Sets the full scale speed indicated by the speedometer gauge.

MPH 15, 20, 25, 30, 35, 40, 45, 50, 55, 60, 70, 75, 80, 85, 95 or 100

km/h 20, 30, 40, 50, 60, 70, 80, 90, 100, 110, 120, 130, 140, 150 or 160

Quad Adjust

Allows the user to disable Adjust mode of the Analog and Digital Gauge Pages. Button 3  disables while button 4  enables Quad Adjust. Disabling Adjust mode locks the current gauge configuration and prevents the operator from accidentally changing the gauge configuration.



Voltmeter

Leave setting at the 12V factory default. (24V is not available on this unit.)

Service Timers

Sets the 16 service intervals in hours and resets the service timer. Setting the service interval to 0 disables the timer and the word Off is displayed.

Pressing button 4  allows adjusting the selected service timer.

Button 1  decreases the service interval time while button 2  increases the service interval time in 10 hour increments. Holding button 3  for approximately three seconds resets Next Service In to the current service

interval. The service timer descriptions can be changed using the CANplus Configurator.

Note: It is not possible to set the service timers if engine hours are not being received by the display.

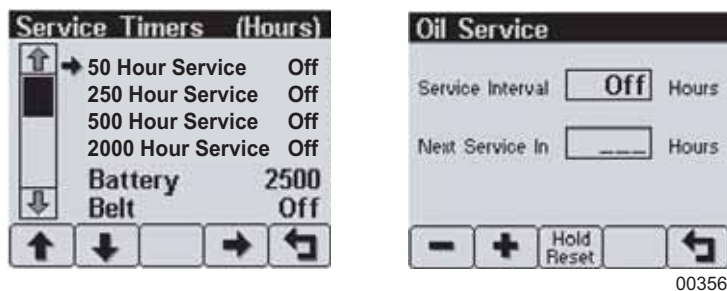

00356

SYSTEM MENU

The System menu allows the user to configure items affecting how the system functions. Button 4 cycles through the available values for the selected item.

Demo

The display supports several demo modes to operate with simulated data. Mode 1 simulates speed data and engine parameters. Mode 2 only simulates engine parameters. Mode 3 simulates speed data, engine parameters and alarms. Mode 0 disables Demo mode. Demo is automatically set to 0 (Off) if live data is received.

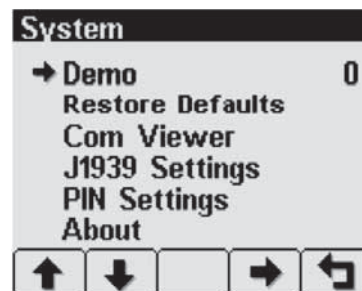

00357

Restore Defaults

This allows resetting of all configuration information to default US or Metric units. Additionally, the display is reset to the initial configuration.

The default settings are:

Setting	US	Metric
Language	English	
Button Beep	On	
Service Timers	Off	
Display Mode	Analog Gauges	
Gauge Pages	Defaults	
Quad Adjust	On	
Demo Mode	0 (Off)	
Engine Source	0	
Display CAN Address	40	
Alarm Filter	Glb	
SPN Version	1	
Speed Source	Auto	
PIN Entry	Off	
PIN	1111	
Max Gauge RPM	2500	
Max Gauge Speed	40 MPH	60 km/h
Speed Units	MPH	km/h

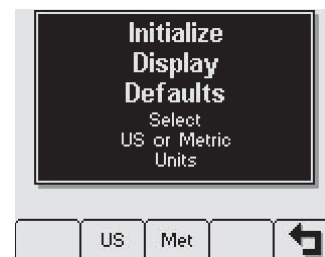

00358

Setting	US	Metric
Distance Units	Miles	km
Pressure Units	PSI	kPa
Volume Units	Gal	l
Temperature Units	°F	°C

Com Viewer

Displays CANbus data received and engine configuration transmitted by the ECU.

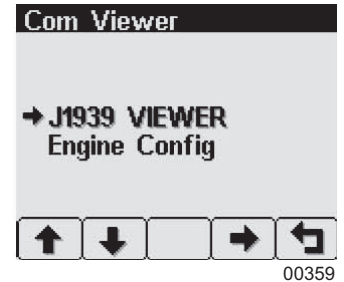



00359

J1939 Viewer

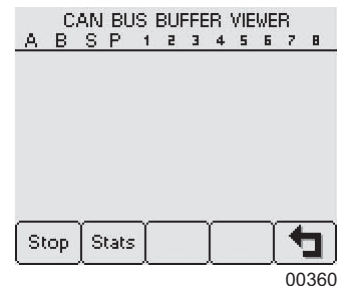
This screen provides a hexadecimal dump of the messages received on the CANbus. This viewer displays the raw data. To see the decoded data, use the Db Viewer.



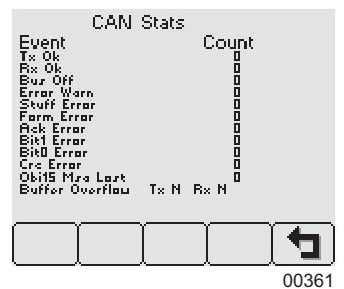

00360

Button 1  freezes the display while button 2  shows the CANbus data statistics screen.



00361

Engine Config

This screen displays the engine configuration information received from the ECU. Button 2  selects the next page of engine configuration while button 1  selects the previous page.

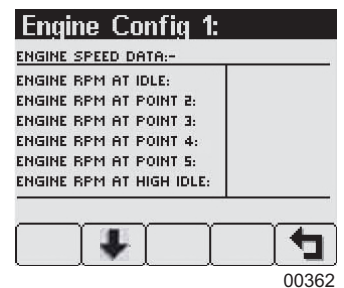

00362

J1939 Settings

This screen allows adjustments specific to the J1939 data link.

Engine Source

Selects which source the display listens to for gauge data. Every device on a J1939 network has a unique address (in the range 0-254) to which the display can choose to listen. The display listens to a single data source; usually the ECU at address 0.

Note: *Incorrectly configuring the Engine Source address will result in no data available for display.*

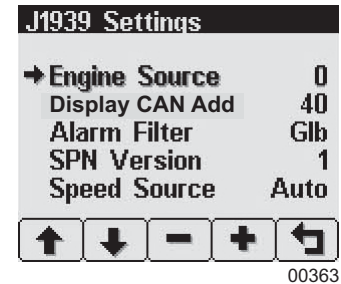

Display CAN Add

As mentioned previously, every device has a unique address and the display is no different. The default display address is 40, the recommended address for single engine setups.

Note: *Incorrectly configuring the Display CAN Address can result in data collisions on the CANbus.*

Alarm Filter

This setting specifies whether the display will display alarms from all sources (*Glb* or global) or only the source address specified in the “Engine Source” setting (*Src* or source).

SPN Version

Selects the default SPN (Suspect Parameter Number) conversion method version automatically.

Note: *Selecting the wrong version will cause alarm data to be displayed incorrectly.*

Speed Source

There are three sources of speed data the display can decode. The settings for this parameter are Auto, NMEA, Wheel, Nav and Off. Auto prioritizes the sources (highest to lowest); NMEA, Wheel (PGN 65265), Nav (PGN 65272). The selection can be forced to one of the available sources by selecting it explicitly. Selecting Off stops the display listening to any source of speed data.

PIN Settings



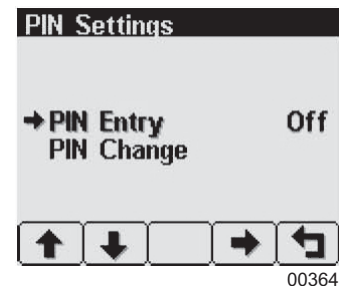

By default, PIN (Personal Identification Number) security is disabled. The user is prompted to enter a PIN every time the Configuration menu is accessed after this feature is enabled.

PIN Entry

This allows turning PIN Entry on or off. To enable the PIN Entry feature, select PIN Settings and press button 4 to enable. As a security feature, a default pin number must be entered. Contact Generac Mobile Products, LLC to obtain the number. Once the PIN has been entered, the feature is enabled. PIN Entry is disabled by setting PIN Entry to Off.



The digits of the PIN are entered by using the buttons corresponding to the digits of the PIN.

Button 1  adjusts the first digit of the PIN. Button 2  adjusts the second digit, button 3  the third digit and button 4  the fourth digit. The PIN is entered using button 5 .

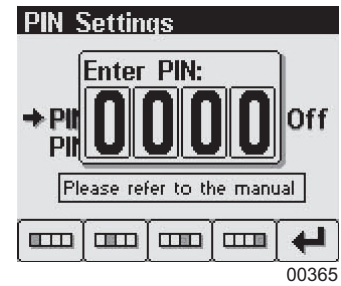

PIN Change

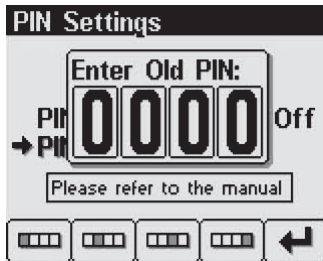

This allows changing the PIN. The user is prompted for the current PIN.

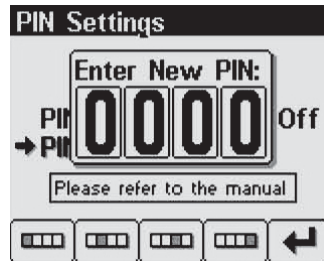

The user is prompted for the new PIN.

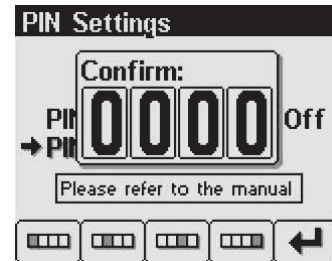

The new PIN must be confirmed before the PIN is changed.

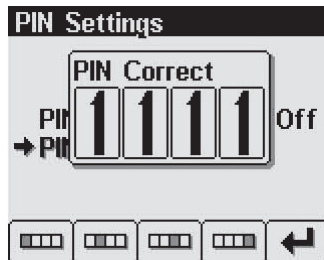

If the new PINs match, a confirmation screen is displayed.

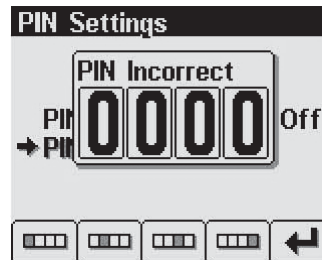

If the two PINs do not match, an error message is displayed and the PIN is unchanged.

00366

⚠ WARNING

If the PIN is changed from the default and the new PIN is lost, the configuration mode will not be accessible. Clearing the PIN requires returning the display to LOFA Industries Inc. for service. Contact LOFA Industries Inc. at 770-569-9828.

About

Displays the following product information:

JOB	N/A
CONFIG	Generac programmed controller part number
ADAPTER	Last adapter serial number used to program the controller
VERS	Software version number
PRODUCT	Controller model name
RUN TIME	Hours the unit has been run

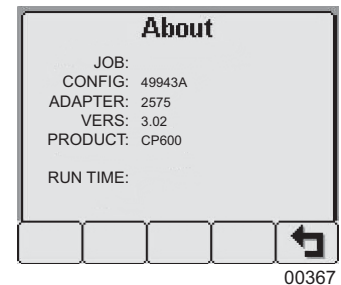

Note: This screen can not be exited until the checksum calculation is complete. Checksum calculation takes approximately 10 seconds and is complete when the checksum value changes from “Calculating”... to a hexadecimal value such as 0x704E – OK.

AUTOSTART MENU

This submenu allows the user to configure automatic start/stop operation. Refer to “Automatic Start/Stop Operation” on page 19 for more information.

Mode

This menu selects the basic automatic start/stop operation mode. Button 4 cycles between Single Switch, Dual Switch, Transducer or Xducer & Sw.

Function

This menu selects the automatic start/stop function. Button 4 cycles between Empty, Fill, Maintain Out and Maintain In.

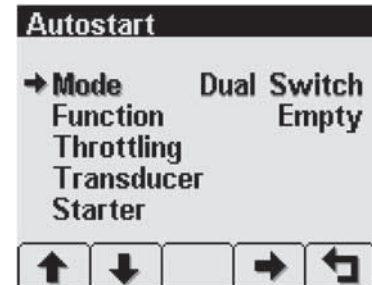

00368

Throttling Menu

The throttling menu allows the user to configure throttle control. It also allows programming the automatic start/stop throttle profiles as shown in Figure 12 on page 19.

Idle RPM

Selects the RPM the control system will request for idle speed. Idle can be set to compensate for parasitic loads such as hydraulic pumps or compressors. Idle RPM is the low speed setting of the optional two state or three state throttle switches.

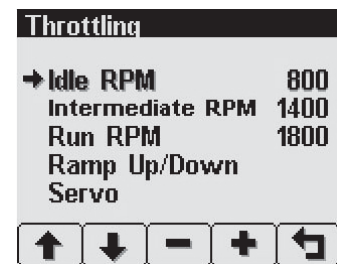

00369

Note: The minimum engine speed is set by the ECU. Requesting a lower speed causes the engine to run at the ECU minimum speed. RPM limits are programmed into the panel to limit the requested speed. Contact Generac Mobile Products, LLC for information on changing the panel minimum requested RPM and maximum requested RPM.

Intermediate RPM

Selects the RPM the control system will request for intermediate speed. The intermediate speed can be used to prime pump or charge lines during automatic start/stop operation. Intermediate RPM is the middle setting of optional three state throttle switches.

Note: Setting the Intermediate RPM to the same speed as Idle RPM and Ramp to Run to zero seconds is effectively two speed automatic operation.

Run RPM

Selects the RPM the control system will request for run speed. The run speed is the normal operating speed during automatic start/stop operation. Run RPM is the high speed setting of the optional two state or three state throttle switches.

Ramp Up/Down

This submenu configures the speed profile for automatic start/stop operation.

Warm Up s

Selects the number of seconds to operate at idle speed before beginning the ramp to intermediate speed. The warm-up time begins when the starter is disengaged.

Ramp Up s

Selects the number of seconds to ramp from idle speed to intermediate speed after warm-up.

Intermediate s

Selects the number of seconds to operate at intermediate speed before ramping to run speed.

Ramp to Run s

Selects the number of seconds to ramp from intermediate speed to run speed after intermediate warm-up.

Ramp Down s

Selects the number of seconds to ramp from current speed to idle speed. The ramp down time begins when the automatic start/stop system detects a stop event.

Cool Down m

Selects the number of minutes to operate at idle speed after ramp down time. At the end of the cool down period, the engine will be stopped.

Ramp Up/Down	
→ Warm Up s	0
Ramp Up s	0
Intermediate s	0
Ramp To Run s	0
Ramp Down s	0
Cool Down min	0

00370

Servo

Configures the servo profile for autostart maintain modes.

Gain

Controls the aggressiveness of the maintain servo modes.

Delay 10mS

Controls how quickly the maintain servo mode responds to changes in level.

Servo	
→ Gain	5
Delay 10mS	1

00371

Transducer

This submenu configures the transducer type and set points.

Type

Selects between Level and Pressure CANplus Configurator.

Range

Selects appropriate range for the transducer type.

High Set Point

For Empty and Maintain Out modes, sets the level that begins and autostart cycle. For Fill and Maintain In modes, sets the level that ends the cycle.

Maintain Point

Sets the target point for maintain modes.

Transducer	
→ Type	Level
Range ft(Psi)	23.1(10)
High Set Point ft	0.0
Maintain Point ft	0.0
Low Set Point ft	0.0
Dead Band ft	0.0

00372

Low Set Point

For Empty and Maintain Out modes, sets the level that ends an autostart cycle. For Fill and Maintain In modes, sets the level that begins a cycle.

Dead Band

Sets the amount of change from the target point required to alter the engine speed.

Starter

This submenu configures starter control options for autostart.

Restart Attempts

Selects the number of times to attempt restart.

Restart Delay Sec

Selects the number of seconds to wait before attempting a restart.

Start on Sec

Selects the maximum number of seconds the starter can be engaged.



00373

SETTINGS MENU

This submenu allows the user to configure CANplus hardware.

Governor

Selects between Elect (electronically governed) and Mech (mechanically governed) engines modes. For mechanically governed engines the CANplus I/O Board functions as an ECU, broadcasting engine parameters such as oil pressure and temperature on the CANbus.

Note: Switching governor modes requires cycling power before calibrating the RPM. The CANplus Configurator must be used to configure mechanical engine parameters.

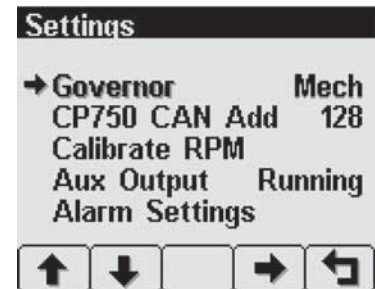

00374

CP750 CAN Add

Selects the address used by the display to communicate with the CANplus I/O Board. The default I/O Board address is 128.

Note: Engine data is always transmitted using address 0 in mechanically governed mode.

⚠ WARNING

Incorrectly configuring the CP750 CAN Address prevents the display from receiving I/O Board data for the display menus and can result in data collisions on the CANbus.

Calibrate RPM

Calibrates the tachometer input for mechanically governed engines to allow the CANplus I/O Board to measure the engine speed. This signal may be provided by an alternator frequency tap, proximity switch. An optional amplifier/divider can be added for use with a magnetic pickup.

Note: Calibrate RPM is only available on mechanically governed engines. The RPM must be calibrated for automatic start/stop operation to function.

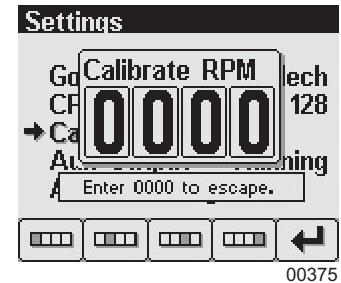

Crank the engine and measure the engine RPM with a hand-held tachometer. Select Calibrate RPM and enter the digits of the measured RPM using the buttons corresponding to the digits of the RPM. Button 1 adjusts the first digit of the RPM. Button 2 adjusts the second digit, button 3 the third digit, and button 4 the fourth digit. The RPM is entered using button 5 .

When the calibration is complete, the LEDs will begin a blinking sequence. The power must be cycled to continue configuration or operation.

Aux Output

Selects the Aux Output function and provides a one amp low side switch.

- Running** The output is active when the engine RPM exceeds 500 RPM.
- AS Armed** The output is active when the key switch is in the Autostart position and the engine has not stopped due to a fault.
- At Speed** The output is active when the engine is at or above the operating RPM.
- Prestart** The output is prestart alarm activated 10 seconds before the engine automatically starts.

Note: The Aux Output is available on a connector in the I/O Board only. Changing the prestart alarm time requires using the LOFA Configurator.

Alarm Settings

Configures the set points for the transducer alarm messages. The alarm is transmitted as SPN 1083 with FMI 1 for a low alarm and FMI 0 for a high alarm.

Low Level ft
Sets the transducer low level alarm set point.

High Level ft
Sets the transducer high level alarm set point.

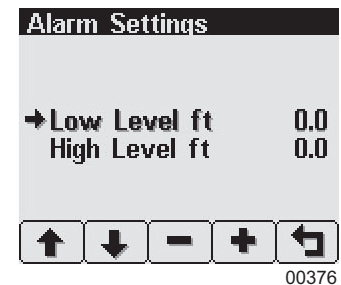

TELEMETRY MENU

This menu allows configuring the optional telemetry system.

Telem J1939 Address

Defines the address the telemetry module is using for CANbus communications.

Note: The display will be unable to communicate with the telemetry module if this address is incorrect.

Modbus Address

Selects the Modbus slave address the telemetry module will use for Modbus communications.

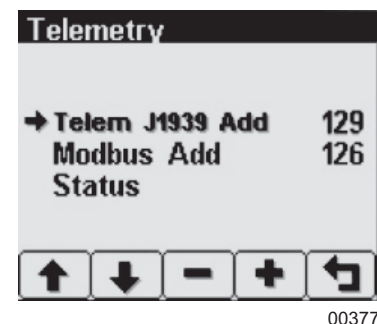

Status

Displays telemetry and modem status information retrieved from the telemetry module:

MODEM TYPE	Identifies the modem type
CELL REG	Identifies cell modem registration
CELL STATE	Indicates cell state and signal strength
GPS	Indicates GPS status
RTC	Indicates number of days since real time clock cellular update
MODBUS SSLT	Indicates Modbus slave status
HDW STATUS	Indicates various hardware status items
SOFTWARE VER	Indicates the version of software in the Messenger

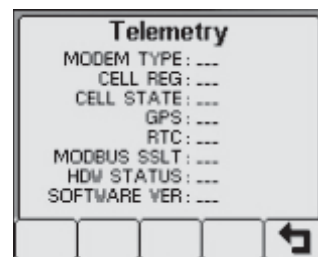

00378

DB VIEWER

The Database Viewer displays and decodes all data monitored by the display. This diagnostic tool allows viewing data not normally displayed.

The list can be scrolled using buttons 1 and 2 and closed by pressing button 5 .

Note: The Database Viewer is always in English regardless of language selected.

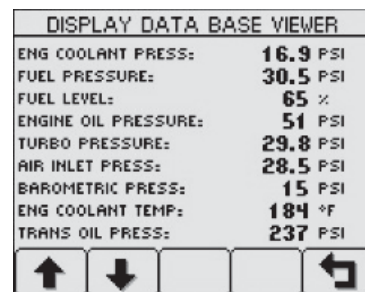

00379

PREFERRED SCREEN STORE

The display automatically stores the current screen as the preferred screen after a delay of approximately 15 seconds. The display will use the last stored screen on the next power up.

Note: Selecting Restore Defaults restores the Analog Gauge Pages and default gauges.

POP-UP MESSAGES AND ALERTS

Service Required

Users can set up to 16 service timers in hours in the Configuration menu. The Service Required pop-up is displayed at power up when one or more service timers has expired. Pressing any button removes the pop-up. If no button is pressed, the pop-up closes in approximately five seconds.

POP-UP WARNINGS OF SERVICE REQUIRED AND DATA COMMUNICATIONS FAILURE

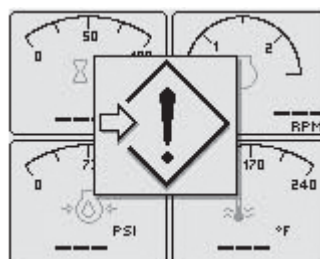

00380

Data Communications Failure

The Data Communications Failure pop-up icon flashes if the display does not detect data. The warning disappears



and normal operation resumes once data is detected.

Note: *Incorrectly configuring the Engine Source address will result in no data available for display.*

Data Not Available

Gauges and the Db Viewer will display **---** if the desired data is not available. The display value returns to normal when parameter data is received.

ADJUSTING LIGHTING AND CONTRAST

Pressing button 5 (the right-hand button) when there is no menu bar opens the lighting and contrast menu bar. The display has a number of backlighting levels, allowing the display to be read in the dark. The level is adjusted by pressing button 1 to decrease, or button 2 to increase  illumination. Contrast is adjusted in the same manner using buttons 3 and 4 .

Note: *The display adjusts the contrast with ambient temperature. Manual contrast adjustments are only necessary with extreme climate change.*

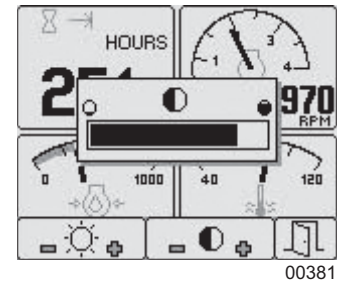

The menu is exited by pressing button 5 . The lighting and contrast settings are retained after the unit is powered off.

Note: *If the contrast has been adjusted poorly, the factory setting is restored by pressing buttons 1 thru 4 simultaneously. This action does not change other user-configured settings.*

INDICATORS

Auto Standby LED (Green)

A solidly illuminated Auto Standby LED indicates the key switch is in the AUTO START position and the system is ready to start.



Preheat LED (Amber)

A solidly illuminated Preheat LED indicates the engine is preheating. When the LED extinguishes, the preheat period is complete and the engine may be cranked.

Note: *The CANplus display only reports when the ECU is requesting preheat. Cold starting aids may not be installed in all engine configurations.*



Engine Stop LED (Red)

A solidly illuminated Engine Stop LED indicates the ECU has stopped the engine due to a fault.

Note: *ECU programming determines the response to warnings and failures. Typically the ECU can be programmed to shut down, derate, or run to failure. The CANplus display only displays ECU reported conditions.*



Warning LED (Amber)

A solidly illuminated Warning LED indicates a warning reported by the ECU.

Note: *The Warning LED is not used in Mechanical Governor mode.*







DATA PARAMETERS MONITORED

This table lists the engine and transmission parameters that are monitored via the CANbus. The parameters can be displayed by the user-configurable gauge pages or the single analog gauge. DB is an abbreviation for the internal database which stores all data transmitted from the engine/transmission. The complete database can be accessed on the display via the Db Viewer in the Configuration menu.

Icon	Parameter	Gauge Pages	Single Gauge	Database
	Electrical Potential	●	●	●
	Battery Voltage, Switched	●	●	●
	Net Battery Current	●		●
	Alternator Voltage	●	●	●
	Alternator Current	●	●	●
Fuel (L, Gal, lGal) or (L/h, Gal/h lGal/h) or (km/L, MPG or IMPG)				
	Fuel Level	●	●	●
	Fuel Rate	●	●	●
	Fuel Temperature	●	●	●
	Instantaneous Fuel Economy	●		●
	Trip Fuel Economy	●		●
	Trip Fuel	●		●
	Trip Fuel Rate	●		●
	Total Fuel Used			●
	Fuel Leakage 1			●
	Fuel Leakage 2			●
Distance (km, Miles or Nmiles)				
	Distance Remaining	●		●
	Trip Distance	●		●
	Total Vehicle Distance	●		●
Pressure (kPa, PSI or bar)				
	Fuel Pressure	●		●
	Barometer Pressure	●		●
	Auxiliary Pressure 1	●		●
	Turbo Pressure	●	●	●
	Air Inlet Pressure	●		●
	Air Filter Differential Pressure	●		●
	Injector Metering Rail 1 Pressure	●		●
	Injector Metering Rail 2 Pressure	●		●
	Engine Coolant Pressure	●		●

Icon	Parameter	Gauge Pages	Single Gauge	Database
	Engine Oil Pressure	●	●	●
	Transmission Oil Pressure	●	●	●
	Clutch Pressure	●		●
	Air Start Pressure	●		●
	Injector Control Pressure	●	●	●
Temperature (°C, °F)				
	Engine Coolant Temperature	●	●	●
	Engine Intercooler Temperature	●		●
	Engine Oil Temperature	●	●	●
	Transmission Oil Temperature	●	●	●
	Turbo Oil Temperature	●		●
	Intake Manifold Temperature	●	●	●
	Air Inlet Temperature	●	●	●
	Exhaust Temperature	●	●	●
	Auxiliary Temperature 1	●	●	●
	Engine ECU Temperature			●
	Exhaust Gas Port 1 Temperature	●		●
	Exhaust Gas Port 2 Temperature	●		●
	Turbo Inlet Temperature	●		●
Percentage (%)				
	Acceleration Position	●		●
	Engine Oil Level	●	●	●
	Coolant Level	●	●	●
	Fan Speed	●		●
	Drivers Demand Percent Torque	●		●
	Actual Engine Percent Torque	●	●	●
	Percent Load at RPM	●	●	●
Speed (RPM, km/h, MPH or KTS)				
	Input Shaft Speed	●		●
	Output Shaft Speed	●		●
	Engine Speed	●	●	●
	Turbo 1 Speed	●		●
	Engine Desired Operating Speed	●		●

General Information

Icon	Parameter	Gauge Pages	Single Gauge	Database
⇒	Fan Speed	●		●
	Vehicle Speed	●	●	●
Time (h)				
 →	Total Engine Hours	●		●
 ←	Trip Engine Hours	●		●
	Service Hours			●
Miscellaneous				
	Torque Converter Lock-Up Engaged			●
	Transducer	●	●	●
	Current Gear	●		●
	Selected Gear	●		●
	CANTX Disable			●
	CANplus I/O			●

WELDING ON EQUIPMENT WITH ELECTRONIC CONTROLS

Proper welding procedures are required to avoid damage to electronic controls, sensors and associated components. The component should be removed for welding if possible.

The following procedure must be followed if the component must be welded while installed on equipment with electronic controls. This procedure will minimize the risk of component damage.

⚠ WARNING

Do not ground the welder to electrical components such as the control ground or sensors. Improper grounding can cause damage to electrical components. Clamp the ground cable from the welder to the component being welded. Place the clamp as close as possible to the weld to reduce the possibility of damage.

1. Stop the engine. Turn the key switch to the OFF position.
2. Disconnect the negative (-) battery cable from the battery.
3. Open any installed battery disconnect switch.
4. Unplug the control system if possible.
5. Connect the welding ground cable as close as possible to the area to be welded.
6. Protect the wiring harness from welding debris and splatter.
7. Use standard welding methods to weld the materials.

Section 3 - Operation

PUMP SET UP

1. Disconnect the pump from the tow vehicle by turning the tongue jack clockwise to raise the tongue from the hitch. Disconnect all safety chains, surge brake cables and the trailer wiring harness. Block the wheels to prevent the unit from rolling.
2. Lower the rear leveling jacks from the travel position. Turn the jack handles clockwise until the leveling feet are in firm contact with the ground. Adjust the jacks until the pump is as level as possible.
3. Attach fittings to both the intake and outlet openings of the pump, making sure they match the fittings on the hoses. Make sure a gasket/seal is in place between the pump volute and the flange on the fitting being attached. Tighten all hardware completely to ensure an airtight seal. Threaded fittings require the use of pipe thread sealant.

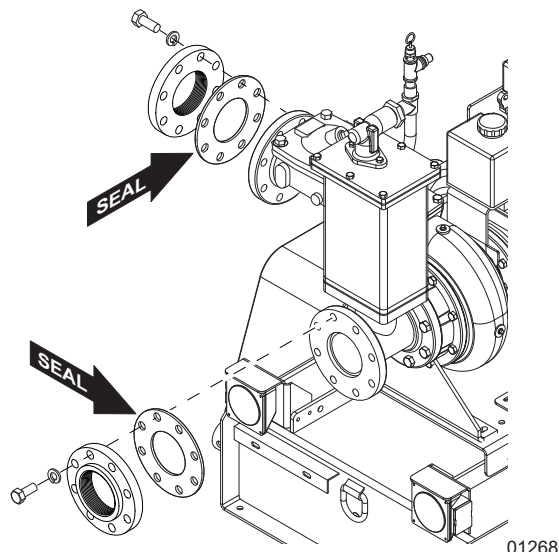

Figure 13 - Pump Seals

4. Attach a rigid hose to the intake (suction) side of the pump. For best performance, the suction hose/piping should be at least as large as the pump flange, never smaller. The pump should be at the highest point of the hose/piping. All suction piping and fittings should be checked for any foreign material (rocks, bolts, wire, etc.) and also any sharp burrs that could disrupt the flow. Make sure the O-ring seal is present in the fitting on the pump before attaching the fitting.

Note: Lubricate the O-ring seal with grease to ensure an airtight seal.

⚠ CAUTION

The suction and discharge pipe/hose material should be compatible with the liquid being pumped. If a hose is used on the suction line, it should be of the reinforced type to prevent collapse under suction lift.

⚠ DANGER

IF A MANUAL SHUTOFF VALVE IS INSTALLED IN THE DISCHARGE LINE, IT MUST NOT BE LEFT CLOSED DURING OPERATION. A CLOSED MANUAL SHUTOFF VALVE WILL CAUSE OVERHEATING AND POSSIBLE EXPLOSIVE RUPTURE OF THE PUMP CASING. PERSONNEL COULD BE SERIOUSLY INJURED.

5. Attach a rigid intake screen or strainer to the end of the suction hose before placing it in the liquid. This will prevent large items or excessive trash from entering the pump housing. The screen must have enough

openings to equal 28 sq. in. (181 sq. cm) or more (6 in. pump). The screen should be rigid enough to prevent collapse when flow is reduced due to clogging.

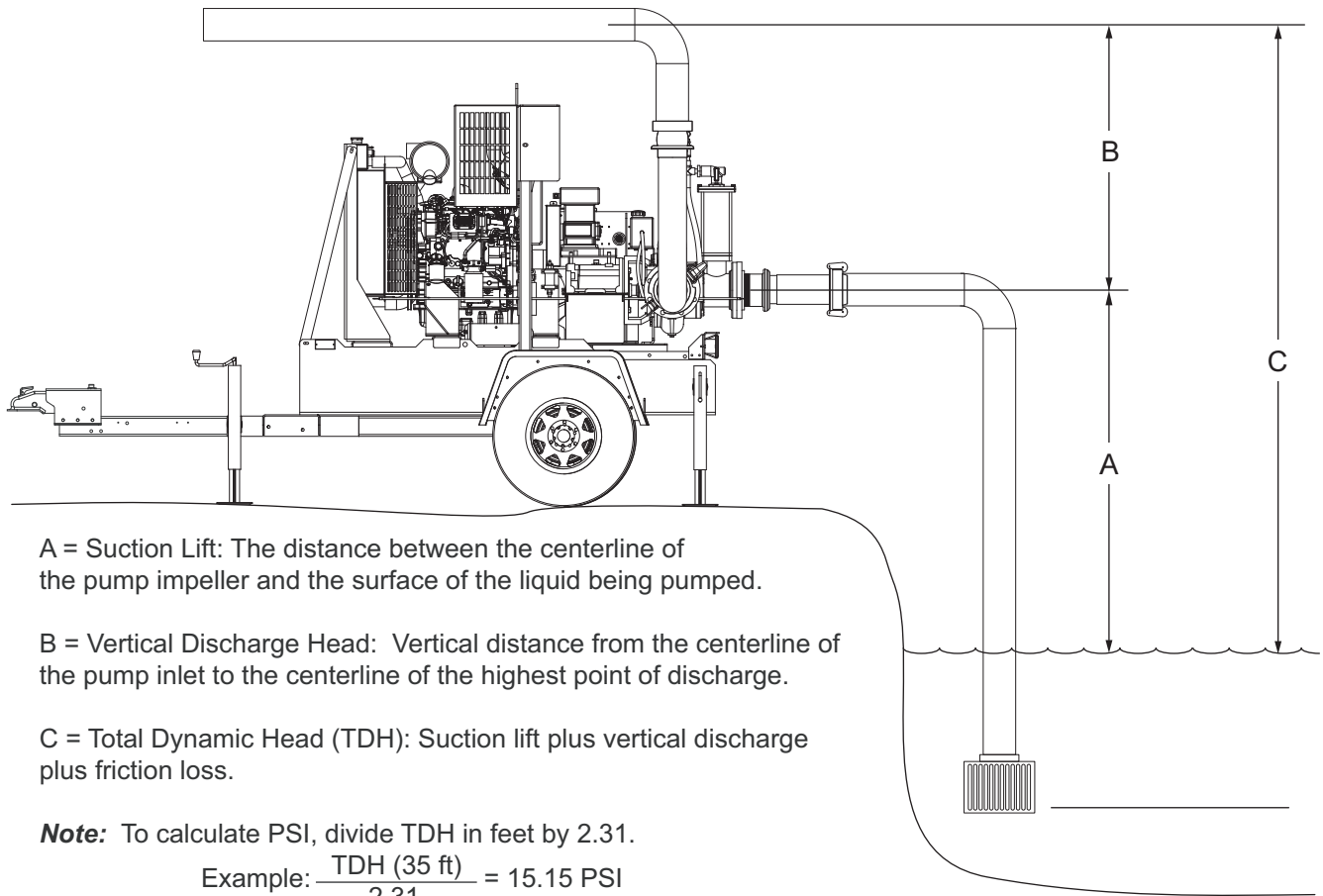

A = Suction Lift: The distance between the centerline of the pump impeller and the surface of the liquid being pumped.

B = Vertical Discharge Head: Vertical distance from the centerline of the pump inlet to the centerline of the highest point of discharge.

C = Total Dynamic Head (TDH): Suction lift plus vertical discharge plus friction loss.

Note: To calculate PSI, divide TDH in feet by 2.31.

Example: $\frac{\text{TDH (35 ft)}}{2.31} = 15.15 \text{ PSI}$

01270

Figure 14 - Suction Specifications

- Place the intake hose into the liquid to be pumped. The submergence of the suction pipe into the liquid should be at least four to five times the pipe diameter. If this is not possible, provide a baffle or a floating board. This is to prevent any vortex action from allowing air into the pipe/hose. For best performance, a bell mouth fitting is recommended. Recommended pipe submergences for various flows as well as recommended bell diameters are shown in the table below. The table data is referenced from ANSI/HI 9.8-1998.

Table 1: Pipe Submergences

FLOW (GPN)	500	1000	1500	2000	2500	3000	3500	4000	4500
SUMMERGENCE WITH BELL (FT)									
Bell Diameter (in)	6.1	8.6	10.6	12.2	13.6	14.9	16.1	17.2	18.3
Submergence (ft)	2.1	2.6	3.0	3.3	3.5	3.7	3.9	4.1	4.3
SUMMERGENCE WITHOUT BELL (FT)									
PIPE ID (in) - No Bell	SUBMERGENCE WITHOUT BELL (FT)								
3	4.7								
4	3.3	6.3							

Table 1: Pipe Submergences

FLOW (GPN)	500	1000	1500	2000	2500	3000	3500	4000	4500
6	2.1	3.7	5.3						
8	1.7	2.8	3.8	4.9	6.0				
10	1.6	2.3	3.1	3.8	4.6	5.4	6.1	6.9	7.6

- Attach a flexible hose to the outlet (discharge) side of the pump. Make sure the O-ring seal is present in the fitting on the pump before attaching the fitting.

Note: Lubricate the O-ring seal with grease to ensure an airtight seal.

- Use a concentric taper on the discharge side to increase discharge pipe/hose diameters. All valving and additional fittings should be the same size as the discharge main-line. The discharge size should be adequate to maintain reasonable velocities and reduce friction losses. It is strongly recommended that a pressure relief valve is installed on the discharge piping.
- Before proceeding, check the intake and outlet hoses for sharp bends or kinks that may restrict pump flow. The intake hose should slope upwards toward the pump to avoid development of air pockets in the hose which may lead to pump cavitation. Keep the hoses as straight as possible.
- The pump is self-priming, but should never be operated unless there is liquid in the pump casing. The pump casing needs to be half filled with liquid in order to prime. Remove the cover from the top of the pump volute and fill the pump casing with water.

PUMP PRE-USE CHECKPOINTS

Before using the pump, be sure to check the following:

- Place the pump as close as possible to the liquid being pumped, keeping the number of hose sections and couplings to a minimum. The pump should be the highest point between the intake and outlet section of the suction hoses.
- Make sure the ground is firm and as level as possible. Block the wheels on the trailer to keep it from moving.
- Check the pump discharge area; make sure discharge will not erode the material under the pump or damage any nearby structures.
- Ensure all hose couplings are of the same size and type.
- All hoses/piping should be supported, braced and lined up square before connecting to the pump flanges. A flexible fitting is recommended on both suction and discharge to eliminate misalignment loads or stresses being transmitted to the pump.

Note: Flexible pipe couplings must be restrained so as not to transmit any strain to the pump flanges when expanding or contracting under pressure. Unrestrained expansion fittings can transmit enormous forces to the pump flanges.

▲ WARNING

The pump is designed to handle water and/or other liquids containing some slurries and other entrained solids up to a certain diameter (Refer to “Pipe Submergences” on page 40 for the correct diameter). It MUST NOT be used to pump volatile, corrosive or flammable materials that can damage the pump, cause pump failure or result in explosion. Serious personal injury could result.

PRESTART CHECKLIST

- Ensure all fasteners at gasketed surfaces are properly tightened.

- Ensure belts and couplings (shaft) are properly adjusted, aligned, and guards are in place.
- Ensure all thrust blocks and supports are adequate.
- Ensure all electrical connections and electrical equipment are installed by a qualified and licensed electrical contractor.
- Never operate electric motors or pump equipment without all protective covers, screens and guards properly in place.
- Ensure pump drain is closed.
- Ensure the pump rotates freely by hand. Check the pump rotational direction with very short on/off power pulses on the starter switch.

▲ CAUTION

Improper pump shaft rotation will cause failure and costly repairs.

- Check the valves for proper position. If connecting to a system that has a discharge gate valve, start with the valve closed. The speed of opening depends upon the size and length of the discharge pipe and capacity of the pump. The valve should not be more than .25 in. (6.35 mm) open until the line is filled. This will reduce the possibility of a water hammer or shock if filling is too rapid.
- Ensure all hose couplings, covers and plugs are tight.
- Check the oil level in the mechanical seal oil reservoir bottle. Do not allow the bottle to run dry.
- For diaphragm vacuum pumps: Check the oil level in the sight glass located at the base of the assembly. Add oil if necessary.

▲ CAUTION

If oil levels are not properly maintained, damage to the pump will result.

- Check lip seal vent for leakage. The bearing oil and mechanical seal oil are each sealed by a shaft lip seal, and a vent to atmosphere exists between these two lip seals to indicate oil leaks from either cavity. If either the bearing oil or mechanical seal oil lip seal leaks, oil will leak from the vent.
- Check the engine oil level, coolant level and fuel level.
- Make sure the battery is connected.
- Make sure the emergency stop switch is pulled out (deactivated).

The pump is now ready for use.

STARTING THE UNIT

Before starting the unit, be sure to check the following:

1. Turn the key switch to the right RUN position. A startup screen will appear. After the startup screen is cleared, the display will show readings on its virtual gauges. Once the gauges appear, crank the engine by turning and holding the key switch in the start position until the engine starts. Refer to *“Control Panel Operation” on page 18* for details.

Note: Venturi prime pumps prime using the vacuum created by the air from the engine compressor flowing through the jet pump. The vacuum of the jet pump is connected to the pump's priming spool. With a flooded suction, use a bleed valve at the top of the volute to allow trapped air to escape. Rotating the pump shaft will release trapped gas in the impeller. If the pump has a float ball priming chamber connected to the priming spool, the jet pump's vacuum line will automatically be shut when the pump is primed.

2. The pump should self prime and begin to discharge liquid within minutes. The pump may not prime immediately because the suction line must first fill with liquid. If the pump fails to prime within five minutes, stop it and check the suction line for leaks.
3. Refer to *“Throttle Control” on page 18* for information on adjusting the pump flow. Several factors can influence pump output:

Operation

Priming time is a function of the volume of air in the suction line and the RPM of the vacuum pump. High lifts and larger suction line diameters will require longer priming times. If the pump will not prime or maintain prime, or if the vacuum pump runs hot or passes water, refer to *“Troubleshooting” on page 71*.

⚠ CAUTION

Do not operate at higher than recommended speed to shorten priming time or the service life of the vacuum pump will be shortened.

When pumping in extremely cold conditions, ice may form on the prime valve seat or linkage, preventing closure and allowing water into the vacuum pump. Close observation must be maintained and the pump shut down at the first signs of excessive water coming from the vacuum pump.

Should the discharge check valve become plugged, the pump must be shut down and the valve cleaned out. Refer to *“Discharge Check Valve” on page 61*. Clogging of the suction strainer or hose may result in loss of prime without recovery. A vacuum gauge can be connected to the tap on the side of the priming chamber to aid in diagnosing such clogs.

RUN-DRY SEAL

The pump is equipped with a run-dry feature. The run-dry feature employs an auxiliary gland and reservoir mounted to the backplate. The rotation of the drive shaft circulates oil from the reservoir to the gland, then back to the reservoir. The oil serves to cool the seal faces even when there is no liquid in the pump casing. A V-ring may be installed when space allows.

With the backup run-dry feature, the pump can operate for a short period of time with no liquid in the pump casing without causing damage to the mechanical seal. The run-dry option is not intended for extended periods of operation without liquid in the pump casing, but rather as a safety feature to save the mechanical seal should the pump unexpectedly lose prime or inadvertently be started without being primed.

Recommended reservoir oil:

- Chevron Turbine Oil GST32 or other ISO viscosity grade 32 or below (synthetic oil recommended)
- Transmission fluid or hydraulic oil

The reservoir oil should be a non-volatile substance that is compatible with the mechanical seal elastomers, will not cause rusting, and will not freeze in cold climates. Refer to *“Run-dry Seal Maintenance” on page 53* for more information.

⚠ CAUTION

Do not run pumps equipped with mechanical seals dry. Damage to the pump will result.

LIQUID TEMPERATURE AND OVERHEATING

The maximum liquid temperature for this pump is 160°F (71°C). Do not apply it at a higher operating temperature. Overheating can occur if the pump is operated with the valves in the suction and/or discharge lines closed. Operating against closed valves could bring the liquid to a boil, build pressure, and cause the pump to rupture or explode. If overheating occurs, stop the pump and allow it to cool before servicing it. Refill the pump casing with cool liquid.

As a safeguard against rupture or explosion due to heat, this pump is equipped with a pressure relief valve that will open if vapor pressure within the pump casing reaches a critical point. **APPROACH ANY OVERHEATED PUMP CAUTIOUSLY.** It is recommended that the pressure relief valve assembly be replaced at each overhaul, or any time the pump casing overheats and activates the valve.

PUMP VACUUM CHECK

With the pump inoperative, install a vacuum gauge in the system. Make sure the pump is at least half filled with liquid. Block the suction line and start the pump. At operating speed, the pump should pull a vacuum of 20 in. (67.7

kPa) of mercury or more. If it does not, check for air leaks at the suction piping gaskets.

BEARING TEMPERATURE CHECK

Bearings normally run at higher than ambient temperatures because of heat generated by friction. Temperatures up to 160°F (71°C) are considered normal for bearings, and they can operate safely to at least 180°F (82°C). Measure the bearing temperature with a contact-type thermometer.

STOPPING THE UNIT

1. Allow the engine to idle briefly before switching the key switch to the OFF position.

NOTICE

Do not use the emergency stop switch unless absolutely necessary. Stopping the pump suddenly may cause shock waves to be transmitted back to the pump volute, causing pump damage. To activate the emergency stop switch, push the red button in. To deactivate the switch, pull the button out.

2. The unit is adequately prepared for outside storage. Refer to *“Mechanical Seal” on page 58* for extended storage suggestions.

NOTICE

If the unit is to remain idle during below freezing conditions, drain the pump to prevent damage from freezing. Also, clean out any solids by flushing with a hose.

AUTOMATIC SHUTDOWN

The unit is equipped with a low oil pressure and a high temperature automatic shutdown system. This system will automatically shut off the fuel supply to stop the engine if oil pressure drops too low or the engine exceeds normal operating temperature. Return the key switch to the OFF position to reset the controller; restart the engine after you have determined the cause of the shutdown. Refer to *“Engine Fault Shutdown Troubleshooting” on page 72* for more information.

EMERGENCY STOP SWITCH

The unit is equipped with one emergency stop switch. For location of the emergency stop switch, refer to *“Component Locations” on page 11*. The red button is clearly labeled “EMERGENCY STOP.”

Activate the emergency stop switch by pushing the button in until it locks down. This opens the fuel circuit, shutting down the engine. The switch will remain locked until it is pulled out.

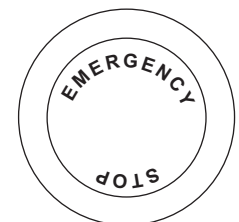

00230

Figure 17 - Emergency Stop Switch

▲ CAUTION

Do not use the emergency stop switch unless absolutely necessary. Stopping the pump suddenly may cause shock waves to be transmitted back to the pump volute, causing pump damage.

REMOTE/AUTO STARTING OPTION

The unit can be configured to start automatically by adding dry-contact closure float level switches. Contact the Generac Mobile Products, LLC Technical Service Department at 1-800-926-9768 for more information on this option.

TOWING THE UNIT

1. Use the jack to raise or lower the trailer onto the hitch of the towing vehicle. Lock the hitch coupling and attach the safety chains or cables to the vehicle. Raise the jack foot completely.
2. Connect any trailer wiring to the tow vehicle. Check for proper operation of the directional and brake lights.
3. Make sure all doors are properly latched.
4. Check for proper inflation of the trailer tires. For maximum tire pressures, refer to *“Specifications” on page 7*.
5. Check the wheel lugs. Tighten or replace any that are loose or missing. If a tire has been removed for axle service or replaced, tighten the lugs in the order shown to the following specifications:
 - a. Start all lug nuts by hand.
 - b. First pass tighten to 20-25 ft-lbs (27-33 Nm).
 - c. Second pass tighten to 50-60 ft-lbs (67-81 Nm).
 - d. Third pass tighten to 90-120 ft-lbs (122-162 Nm).

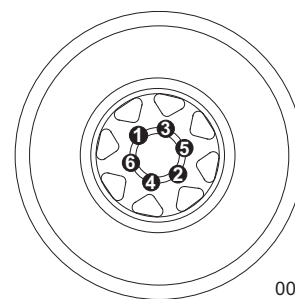

00205

Note: After the first road use, re-torque the lug nuts in sequence.

Figure 18 - Lug Sequence

6. Maximum recommended speed for highway towing is 45 mph (72 km/h). Recommended off-road towing speed is not to exceed 10 mph (16 km/h) or less, depending on terrain.

TRAILER WHEEL BEARINGS

Some trailers are equipped with a grease zerk fitting to allow lubrication of the wheel bearings without the need to disassemble the axle hub. To lubricate the axle bearings, remove the small rubber plug on the grease cap, attach a standard grease gun fitting to the grease zerk fitting and pump grease into the fitting until new grease is visible around the nozzle of the grease gun. Use only a high quality grease made specifically for lubrication of wheel bearings. Wipe any excess grease from the hub with a clean cloth and replace the rubber plug when finished. The minimum recommended lubrication is every 12 months or 12,000 miles (19,312 km). More frequent lubrication may be required under extremely dusty or damp operating conditions.

LIFTING THE UNIT

Remove suction and discharge piping from pump prior to moving. Make sure the equipment being used to lift the unit is in good condition and has sufficient capacity.

Note: Refer to “Specifications” on page 7 for approximate weights.

Always remain aware of the position of other people and objects around you as you move the unit.

A central lift point is located on the top of the unit. Attach any slings, chains or hooks directly to the lift point. Use the forklift pockets with care. Approach the unit as perpendicular as possible to avoid any damage to the unit. Make sure any obstructions are clear of the forklift tines before lifting.

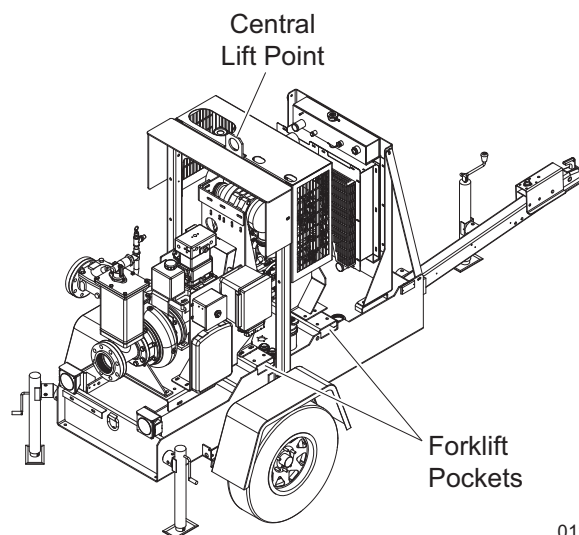

01273

Figure 19 - Lifting Points

▲ WARNING

Use lifting and moving equipment that is in good condition and that has adequate capacity to prevent personal injury or equipment damage. When lifting the pump end with chains or cables, position them so the load is balanced and so pump damage will not occur. Suction and discharge hoses and piping must be removed from the pump before lifting.

Section 4 - Maintenance

Normal maintenance service and replacement of parts are the responsibility of the owner/operator and, as such, are not considered defects in materials or workmanship within the terms of the warranty.

Poorly maintained equipment can become a safety hazard. In order for the equipment to operate safely and properly over a long period of time, periodic maintenance and occasional repairs are necessary. **NEVER** perform even routine service (oil/filter changes, cleaning, etc.) unless the key switch is turned to OFF and the negative (-) cable on the battery is disconnected. Attach a "DO NOT START" sign to the control panel. This will notify everyone that the unit is being serviced and will reduce the chance of someone inadvertently trying to start the unit. Make sure engine and pump components are adequately cooled before attempting any service or maintenance work.

For detailed engine maintenance procedures, refer to the engine operator's manual, which was supplied with the unit when it was shipped from the factory.

▲ WARNING

Before attempting to service the unit, read this manual carefully. Also review all tags and labels/decals provided on the equipment. Operating and maintenance personnel should have a good understanding of all aspects of this unit and the pumping conditions. Failure of operating personnel to be familiar with all aspects of pump operation outlined in this manual could contribute to equipment damage, bodily injury or possible death.

Before servicing:

1. Verify that the key switch is turned to OFF and the negative (-) cable on the battery is disconnected.
2. If the pump or components are hot, allow adequate cooling prior to servicing the unit.
3. Close the suction and discharge valves.
4. Vent the pump slowly and drain completely.

▲ CAUTION

Do not allow compressed air to pressurize the pump or vent-off compressed air through the pump, as this may damage the pump and cause serious personal injury.

▲ WARNING

If this unit is used to handle any hazardous materials that can cause injury or illness, take precautions by wearing approved protective clothing and use appropriate safety equipment.

When servicing the unit, use only components provided by the OEM or Generac Mobile Products, LLC. Any use of non-authorized parts could result in sub-standard performance, damage to equipment and possible injury to personnel. Use of unauthorized parts will also void the warranty.

Refer to the troubleshooting section on [page 71](#) to help diagnose operational or performance problems. Only disassemble the unit components required to remedy the problem condition. Select a clean suitable location for any required maintenance, and note that all work must be performed by qualified personnel.

DAILY WALK AROUND INSPECTION

Look for conditions that could hinder performance or safety, such as (but not limited to) oil/coolant/fuel leakage, blocked vents, loose/missing hardware and electrical connections.

Visually inspect the engine fan belt for cracks, fraying, stretching and that the belt is properly seated in pulley grooves. Replace the belt according to the manufacturer's recommendations.

NOTICE

Failure to perform a daily inspection may result in serious damage to the prime mover.

GENERAL MAINTENANCE

NOTICE

Refer to the original equipment manufacturer's operating manual for a complete list of maintenance requirements. Failure to comply with the procedures as described in the engine operator manual will nullify the warranty, decrease performance and cause equipment damage or premature equipment failure. Maintenance records may be required to complete a warranty request.

Use the schedule in the following table as a guide for regular maintenance intervals.

Table 2 - Basic Maintenance Schedule

Item	Daily	50 Hours	Every 500 Hours	Every 1000 Hours	Every 1500 Hours	Every 2 Years
Check Coolant Level	◆					
Check Oil Level Sight Gauge (diaphragm only)	◆					
Check Fuel Level	◆					
Check Tire Pressure	◆					
Check Electrical Connections	◆					
Inspect Radiator Fins for Debris (clean as required)	◆					
Check Mechanical Seal Oil Level	◆					
Check Flange Fitting Hardware	◆					
Check Engine for Leaks	◆					
Check Exhaust System for Leaks	◆					
Check Suction Air Filter/Dry Air Filter	◆					
Empty Water Tank in the Fuel Pre-filter	◆					
Check V-belts			◆			
Check Coolant (additive concentration)			◆			
Check Intake Air Pipes for Damage			◆			
Replace Pump Lubricating Oil			◆			
Replace Fuel Filter Cartridge			◆			
Change Engine Oil and Filter		◆*	◆			
Check Battery and Cable Connectors				◆		
Check Cold Starting Devices				◆		
Check Engine Mounting (tighten, replace if damaged when necessary)				◆		
Check Fastenings & Hose Unions/Clips				◆		
Replace Engine Air Cleaner Element				◆		
Replace V-belt				◆		
Change Compressor Air Cleaner Element				◆		
Grease Pump Bearings					◆**	
Drain the Bearing Housing					◆	◆
Replace Coolant						◆

* Change the engine oil and oil filter after the initial 50 hours of operation, then at the appropriate interval thereafter. Refer to engine manual for engine oil recommendations.

** Add three to six pumps of grease at each grease zerk fitting with a hand grease gun. Refer to [Figure 8 on page 14](#) and [Figure 9 on page 15](#) for grease zerk locations.

Checking the Engine Oil

Low engine oil and overfilling lead to engine damage. The oil level may only be checked with the engine in a horizontal position and switched off. If the engine is warm, switch off the engine and check the oil level after five minutes. If the engine is cold, you can check it immediately.

⚠ WARNING

Be careful of hot lubricating oil. Scalding can occur. Do not pull out the dipstick while the engine is running.

1. Pull out the dipstick and wipe off with a lint-free, clean cloth.
2. Insert the dipstick into the engine again as far as it will go.
3. Pull out the dipstick again and read the oil level. The oil level must always be between the MIN and MAX marks. Top up to the MAX mark if necessary.

Checking the Oil Level Sight Gauge (Diaphragm Pump Only)

Check that oil is visible in the sight glass located on the side of the bearing housing of the diaphragm vacuum pump. (It is recommended that the sight glass be checked daily.) If no oil is visible, oil will need to be added.

1. Shut down the unit.
2. Remove the pipe plug located at the top of the housing (refer to [Figure 25 on page 64](#)).
3. Add 10W-30 oil until the static oil level is below the center of the sight glass. **DO NOT OVERFILL.**
4. Reinstall the pipe plug.

Changing the Engine Oil

1. Warm up the engine (oil temperature greater than 176°F (80°C)).
2. Ensure the engine is in a level position.
3. Turn the engine off.
4. Place a collecting receptacle underneath the lube oil drain screw.
5. Unscrew the lube oil drain screw and drain the oil into the receptacle.
6. After the oil has drained completely, fit the oil drain plug with a new sealing ring and reinstall the plug, tightening to 41 ft-lbs (55 Nm).
7. Remove the engine oil fill cap and add the recommended amount and type of oil. Refer to the engine manual for specifications.
8. Warm up the engine (oil temperature greater than 176°F (80°C)).
9. Ensure the engine is level and check the oil level. Refer to [“Checking the Engine Oil” on page 51](#).

Changing the Oil Filter

Note: The filter cartridge should never be pre-filled. There is a danger of dirt contamination.

1. Loosen and unscrew the filter with filter tool. Refer to engine manual for more information.
2. Collect the draining engine oil.
3. Clean the sealing surface of the filter support with a lint-free, clean cloth.
4. Oil the gasket of the new filter cartridge lightly.
5. Screw on the new filter by hand until the gasket is touching and then torque to 11-13 ft-lbs (15-17 Nm).
6. Fasten the twist protection clamps (optional).

RESETTING THE CANPLUS 750 CONTROLLER

1. Hold the far right button to enter the Configuration menu.
2. Enter password 4444.
3. Enter Display
4. Select service interval to change/reset.

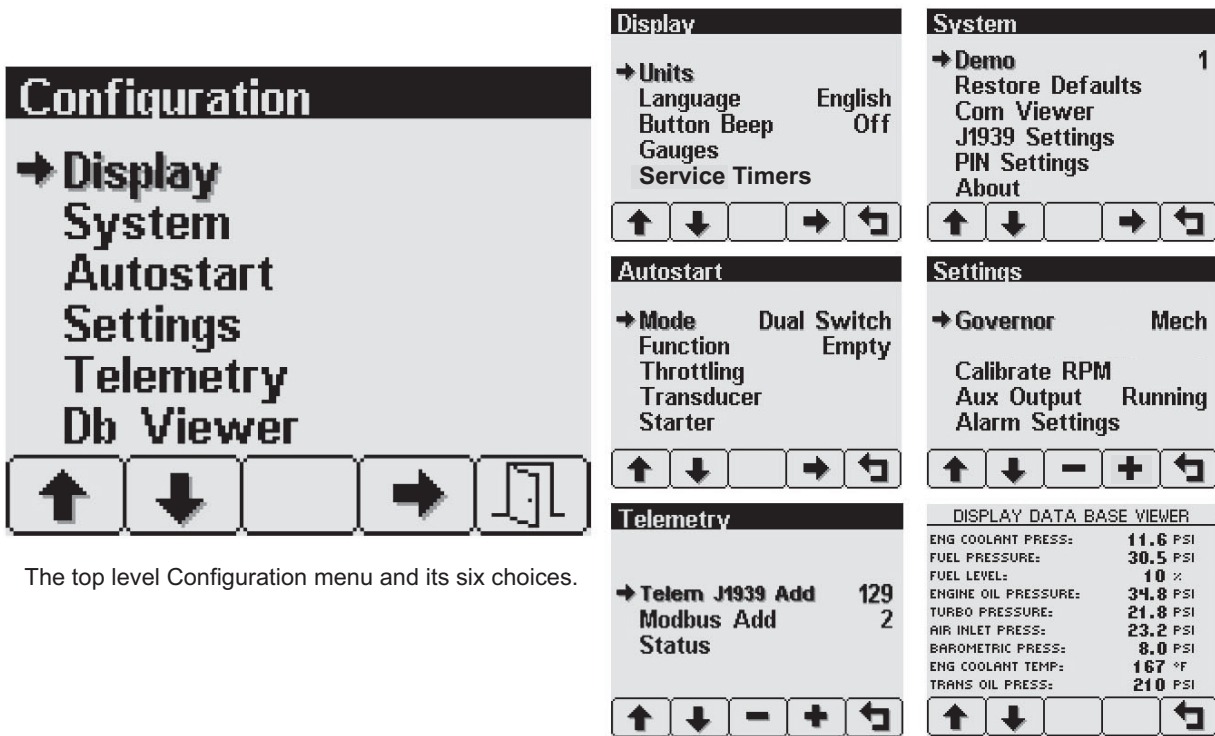

00351

Adjusting The Service Timers

- Pressing button 4 allows adjusting the selected service timer. Refer to *“Service Timers” on page 25* for more information.

JACK MAINTENANCE

The following procedures should be performed at least annually.

Side-wind Models

- The internal gearing and bushings of the jack must be kept lubricated. Apply a small amount of automotive grease to the internal gearing by removing the jack cover, or if equipped, use a needle nose applicator or standard grease gun on the lubrication point found on the side of the jack near the crank. Rotate the jack handle to distribute the grease evenly.
- A lightweight oil must be applied to the handle unit at both sides of the tube.
- If equipped, the axle bolt and nut assembly of the caster wheel must also be lubricated with the same lightweight oil.

Top-wind Models

- Apply a lightweight oil to the screw stem.

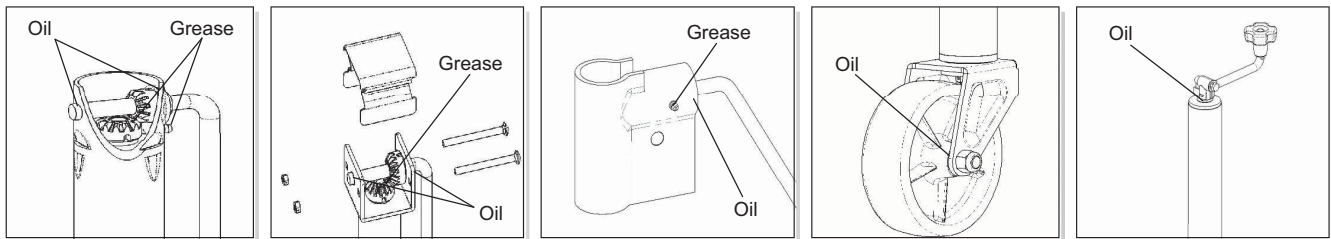

00243

Figure 20 - Lubrication Points

RUN-DRY SEAL MAINTENANCE

The mechanical seal oil level should be maintained to the top line of the reservoir; however, oil will circulate as long as the oil level is above line of the reservoir. Refer to the *“Basic Maintenance Schedule”* on page 50 for recommended mechanical seal oil change interval.

Mechanical seal oil can be added either during pump operation or while shut down. If water begins to accumulate in the reservoir, or the oil level depletes rapidly, this may indicate mechanical seal failure. Leakage of oil from the gland would indicate a damaged or worn lip seal. Refer to *“Run-dry Seal”* on page 45 for oil recommendations.

Wear Rings

Wear rings are vital for successful pump operation. They reduce the pressure at the stuffing box and they reduce axial thrust loads. Wear rings should be replaced if the clearance has increased to about .03 in. (.76 mm) per side.

SERVICING THE PUMP

Pump Disassembly

1. Remove all capscrews from the volute. Insert two of the capscrews into the tapped holes in the backplate. Make sure the volute doesn't fall onto the impeller.

- Remove the impeller lockscrew with a breaker bar. Do not use an impact wrench. Make sure to apply steady and even torque to break lockscrew loose. Allen head tooling to remove the lockscrew should be in excellent condition. Discard the lockscrew. Remove the impeller washer. Refer to [Figure 21](#) and [Figure 22](#).

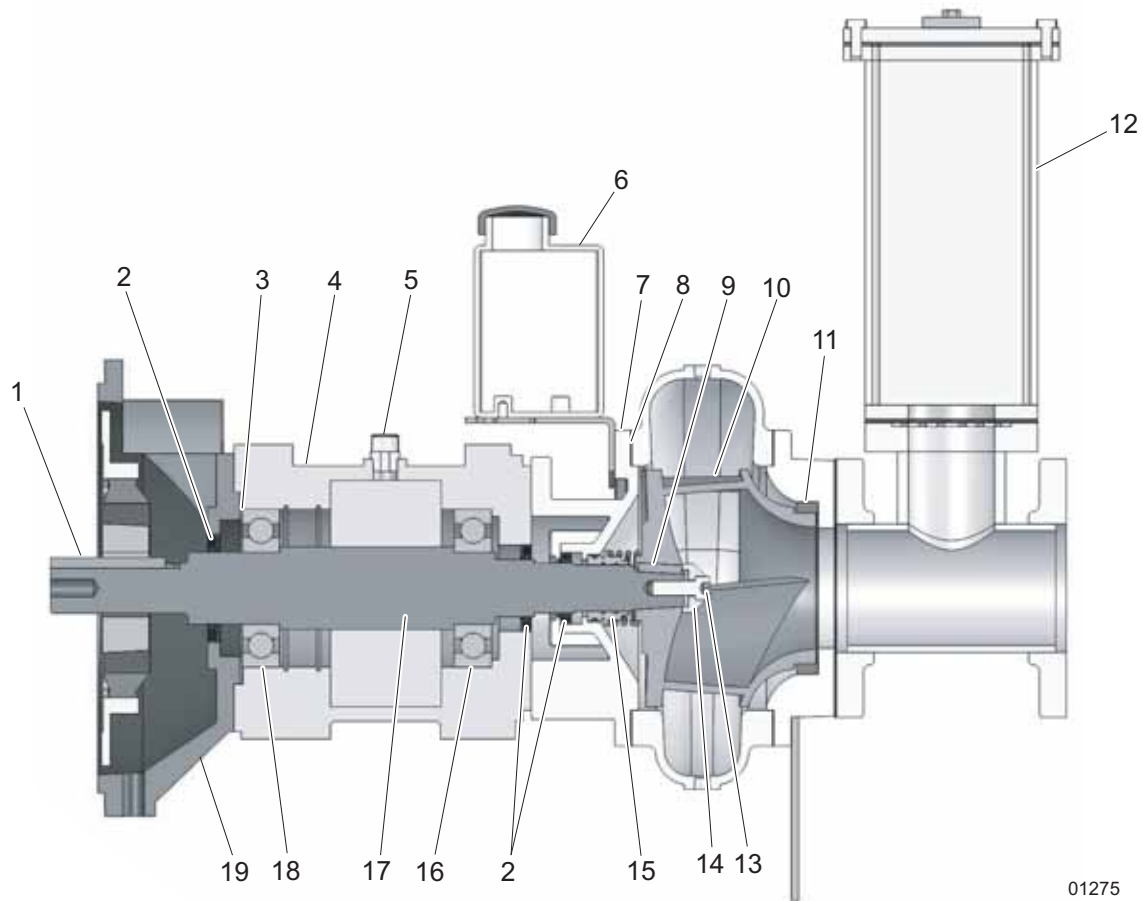
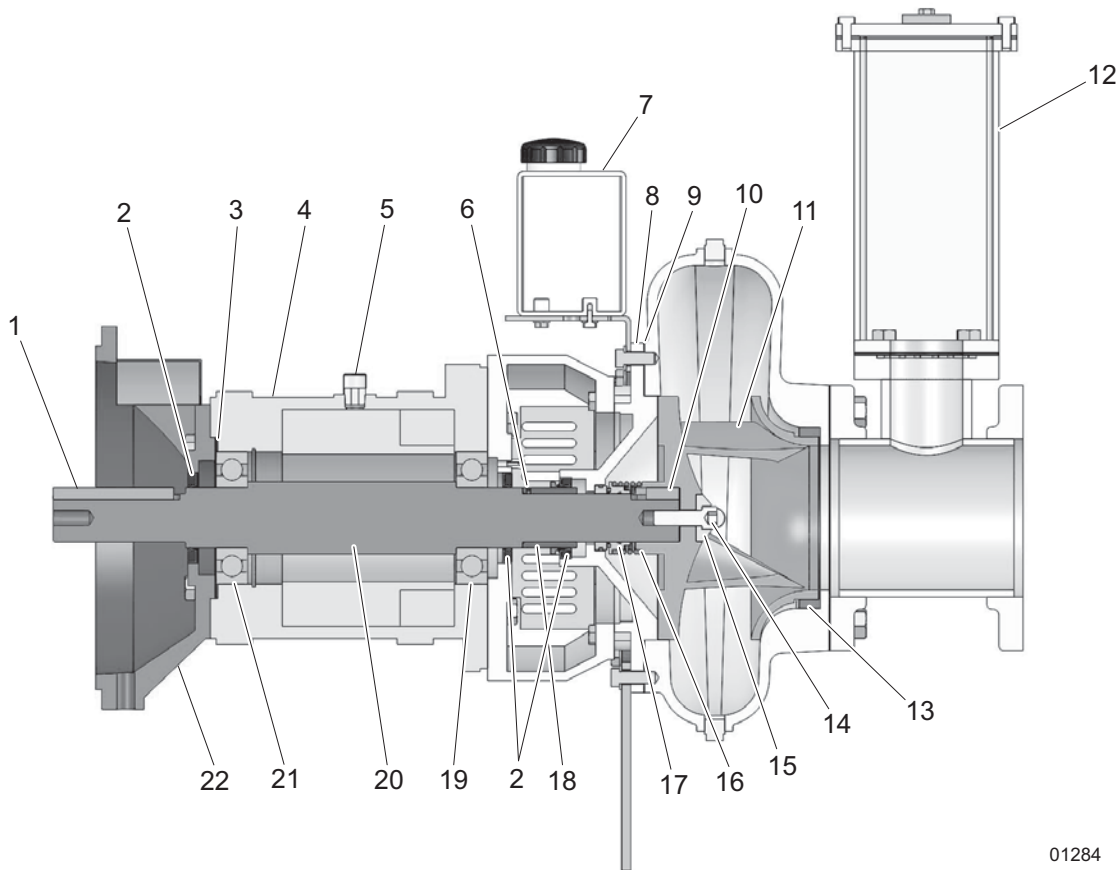

Figure 21 - 4 Inch Pump Cross-Section

- | | |
|----------------------------------|------------------------|
| 1. Shaft key | 11. Wear ring |
| 2. Lip seals (3) | 12. Priming chamber |
| 3. Shims | 13. Impeller lockscrew |
| 4. Frame | 14. Impeller washer |
| 5. Breather | 15. Mechanical seal |
| 6. Mechanical seal oil reservoir | 16. Pump end bearing |
| 7. Backplate | 17. Shaft |
| 8. Volute gasket | 18. Drive end bearing |
| 9. Impeller key | 19. Engine bracket |
| 10. Impeller | |

- Remove any flush lines to the seal gland. Remove the gland capscrews evenly until capscrews are free of the backplate.
- Space wedges in pairs 180° apart between the impeller and backplate. Be sure the wedges are placed along impeller vanes. Tap opposed wedges at the same time to force off the impeller. Use extreme care to avoid damage to impeller, shaft and bearings. Remove the impeller and impeller key.
- Unbolt and remove the backplate from the bracket. Remove the mechanical seal.

6. The suction wear ring can be removed by drilling the ring longitudinally in three places to relieve compression and collapsing the three sections together. Use care not to drill into the volute casting. Better control is obtained if small pilot holes are first drilled and then enlarged to “cut” the ring. This same technique can be used to remove the hub wear ring.



01284

Figure 22 - 6 Inch Pump Cross-Section

- | | |
|----------------------------------|-------------------------|
| 1. Shaft key | 12. Priming chamber |
| 2. Lip seals (3) | 13. Wear ring |
| 3. Shims | 14. Impeller lock screw |
| 4. Frame | 15. Impeller washer |
| 5. Breather | 16. Impeller shims |
| 6. O-ring (sleeve) | 17. Mechanical seal |
| 7. Mechanical seal oil reservoir | 18. Shaft sleeve |
| 8. Backplate | 19. Pump end bearing |
| 9. Volute gasket | 20. Shaft |
| 10. Impeller key | 21. Drive end bearing |
| 11. Impeller | 22. Engine bracket |

Pump Reassembly

1. Each mechanical seal has its own particular assembly procedures. Refer to *“Mechanical Seal” on page 58.*
2. Replace the backplate.

3. Use new gaskets. In case of an emergency situation where you need to reuse the old gaskets, make sure the gaskets are moist and flat.
4. Replace the impeller key and impeller. For solids handling pumps, install the impeller shims to maintain .030 inch minimum clearance between the backplate and impeller backvanes. Use the a long capscrew and several washers to press on the impeller. Do not use the impeller lock screw. The threads must be long enough to enter the shaft approximately eight threads or turns by hand. This is necessary to protect the threads in the shaft.
5. After replacing the impeller, remove the long capscrew and replace with the impeller lock screw with the impeller washer. The impeller lock screw should always be new. Refer to table “*Lockscrew Torque Values*” for torque requirements.
6. Replace the volute, sliding it carefully over the register. Bolt the volute to the backplate.
7. For seals, bring the gland and gasket against the face at the seal chamber and tighten the bolts evenly.

IMPELLER LOCKSCREW INSTALLATION

Impeller lock screws are always right hand socket head capscrews. Stainless steel lock screws are supplied with Loctite 262, which should be applied to lock screw threads and shaft prior to installation.

First determine the size and material of the lock, then torque to the appropriate value listed in the table below.

Table 3 - Lockscrew Torque Values

Size	Torque for Stainless Steel Lockscrew (nonmagnetic) 302, 303, 304, 316 Series
.38- 6UNC	20 ft-lbs (27 Nm)
.50-13UNC	40 ft-lbs (54 Nm)
.62-UNC	90 ft-lbs (122 Nm)
.75-10UNC	135 ft-lbs (183 Nm)
1.00-8UNC	265 ft-lbs (359 Nm)
1.12-7UNC	360 ft-lbs (488 Nm)
1.25-7UNC	510 ft-lbs (691 Nm)
1.50-7UNC	875 ft-lbs (1186 Nm)

Lubrication

Do not lubricate the impeller lock screw or tapped hole, between the lock screw and impeller washer, or between the impeller washer and impeller. Make sure parts are clean and dry; however, it is not necessary to remove the protective coating from the screw. Lubricated bolts can be overstressed with the torques indicated.

DO NOT USE THE LOCKSCREW TO INSTALL THE IMPELLER.

▲ CAUTION

Lockscrew failure can damage the impeller and volute. The impeller screw must be of the best material, properly forged and machined to rigid specifications not available from local suppliers. Purchase only lock screws available from Generac Power Products to be sure of quality.

Impeller Lockscrew Removal

1. Break the impeller lock screw loose with a breaker bar.

▲ CAUTION

Care should be taken when removing lockscrew to prevent damaging the screw head.

2. If the breaker bar will not loosen the impeller lockscrew, apply heat to the lockscrew for 2-4 minutes. Do not exceed 400°F (204°C).

▲ WARNING

Care should be taken when applying heat so as not to receive serious burns.

3. Allow lockscrew to cool and remove with a breaker bar.

FRAME DISASSEMBLY AND ASSEMBLY**Disassembly**

1. Remove the deflectors from the shaft.
2. Remove the drive end shaft key.
3. Remove the capscrews from the bearing cover or drive end bracket.

Note: Grease lubricated frames have a single lip seal at the drive end pump ends. If the lip seals are to be saved, the shaft should be cleared of burrs or sharp protrusions which would cut the seal. If the seals are removed or replaced, refer to [Figure 21](#) or [Figure 22](#) for orientation of the lips. Paired seals have a grease passageway between them and are arranged so that the grease will move through the inner and outer seal.

4. Slide the bearing cover or drive end bracket off the shaft. Remove the capscrews from the pump bracket. Slide the pump bracket off the shaft.
5. The shaft and bearings can now be removed by pressing on the drive end of the shaft.
6. Remove the bearings from the shaft with a bearing puller. If the bearings are to be saved, keep them absolutely clean. If contaminated, wash only in clean fluid.

▲ CAUTION

Never hammer the shaft or parts attached to the shaft or you will damage both the shaft and the bearings.

Assembly

1. Press the drive end and pump end bearings onto the shaft. Pressure should be applied to the inner race.
2. Press the shaft into the frame through the drive end until the pump end bearing is approximately flush with the pump end of the frame.
3. Install the pump end lip seal(s) into the bracket. Slide the pump bracket over the shaft, taking care not to damage or fold the lip seal(s). Install and tighten the capscrews.
4. Install the lip seal(s) in the bearing cover or drive end bracket. Reinstall the shims in the drive end of the frame (if present when disassembled). If new shaft, bearings, frame, bearing cover or drive end bracket are being installed, insert shims to maintain 0.007-0.012 in. (0.177-0.304 mm) shaft end play. Slide the bearing cover or drive end bracket over the shaft. Install and tighten the capscrews.
5. Install the deflector and lubricate. Refer to [“Lubrication Instructions” on page 58](#).

LUBRICATION INSTRUCTIONS

Bearings in all frames are greased at the factory before shipment.

Lubrication requirements vary with speed, power, load, ambient temperatures, exposure to contamination and moisture, seasonal or continuous operation and other factors. The brief recommendations which follow are general in nature and must be coupled with good judgment and consideration of the application conditions. For re-greasing periods, refer to the table below. When adding grease, be sure the grease and fittings are absolutely clean.

Grease used for these bearings should be equivalent to one of the following manufacturer's products:

- G.E. Long Life Grease No. D682C5
- Mobil Mobilux No. EP2
- Shell Alvania EP2
- Texaco Multifak AFB 2

To lubricate frame bearings, remove the plastic cover and zerk fittings. Make sure the fitting and end of the grease gun are clean. Use a hand-operated grease gun and pump a small amount into each bearing cavity. The surplus grease will go through the bearing and into the center part of the frame.

For re-greasing periods and approximate quantity, refer to the table below.

First determine frame size (located on serial number plate).

Example: 5HH-65B4, 4NNT-VF16, 10YB-F18DB, 6NHTA-VC18, 4RB-EM16

Table 4 - Recommended Re-Greasing Periods for Frames

	Frame Size				
	2-5-11 and EM309	6-7-8-16 60B4 through 68B4	10-12-13-13D 18-18D	20-24	30
Total Running Time	2,000 hours	1,500 hours	1,000 hours	1,350 hours	2,000 hours
8 Hour Day Service	36 weeks	27 weeks	18 weeks	24 weeks	36 weeks
24 Hour Day Service	12 weeks	9 weeks	6 weeks	8 weeks	12 weeks
Approximate Amount of Grease per Line Fitting	.5 cubic inch	1.25 cubic inch	2 cubic inch	3 cubic inch	4 cubic inch
Approximate No. of Pumps with Grease Gun (hand operated)	3 pumps	6 pumps	12 pumps	18 pumps	23 pumps

MECHANICAL SEAL

The location of the mechanical seal in your pump is shown in [Figure 23](#). The stationary seat is held in the backplate. All other parts of the seal rotate with the shaft and impeller. The seal chamber must be full of liquid before operating the pump.

No maintenance is required for the mechanical seal. However, the pump should be examined at regular intervals for leakage resulting from wear of the sealing faces. Occasionally, new installations will leak for a short time. These must be inspected daily. If the leakage does not reduce to almost zero, the assembly should be examined for proper seal installation. Replace damaged seals or mechanical seal oil as necessary.

Removing the Mechanical Seal

If the seal is to be removed, remove the impeller according to the instructions for dismantling the pump. The rotating portion of the seal may now be seen. Slide off the seal spring. Lubricate the shaft and remove the remainder of the rotating portion, being careful to avoid damaging the primary seal. The rubber bellows will be firmly attached to the shaft and considerable pressure will be required to remove it. Refer to [Figure 23 on page 59](#).

Removing the O-ring Seat

If the seal is being replaced, remove the backplate (gland is built in) and press out the stationary seat.

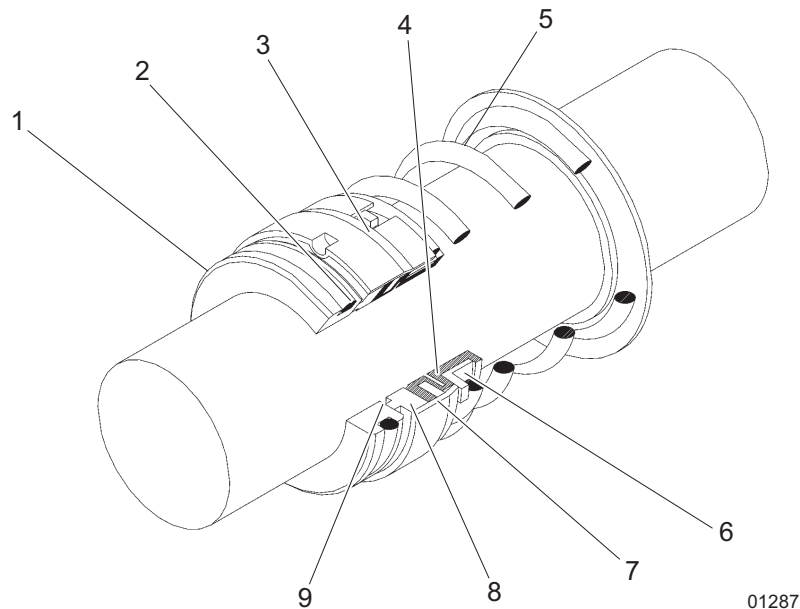

Figure 23 - Mechanical Seal Components

- | | |
|--------------------|-------------------------|
| 1. Stationary seat | 6. Driving band |
| 2. O-ring seat | 7. Disc |
| 3. Retainer | 8. Rotating seal face |
| 4. Bellows | 9. Stationary seal face |
| 5. Spring | |

Installing the O-ring Seat

Clean all parts before starting reassembly. Oil the outer surface of the seat and the O-ring with a light oil (not grease). Place a cardboard disc on the sealing face to avoid damage. Press the seat into the gland or stuffing box using firm, steady pressure. Make sure the seat is all the way in. Slide the gland with the gasket or backplate over the shaft. Install the backplate, then press the seat into the backplate.

Installing the Mechanical Seal

Clean all parts of the pump before starting reassembly. Special attention should be given to the backplate and the impeller hub.

1. Clean and lubricate the shaft.

NOTICE

Once the rotating portion has been placed on the shaft, the rest of the installation must be made at once.

2. Install the stationary seat in the backplate.
3. Oil the outer surface of the seat and the O-ring with a light oil (not grease). Place a cardboard disc on the sealing face to avoid damage. Press the seat into the gland or stuffing box using firm, steady pressure. Make sure the seat is all the way in. Slide the gland with the gasket over the shaft.

4. Wipe the lapped sealing faces of the seat and the primary seal perfectly clean. Use extreme care to avoid marking the sealing face or the primary seal. Slide the rotating portion of the seal, including the spring, along the shaft.

NOTICE

Once the rotating portion has been placed on the shaft, the rest of the installation must be made at once. Delay may result in the rubber bellows seizing on the shaft in the wrong position.

Install the impeller. Be sure that the spring slides over the impeller hub and pushes against the backshroud of the impeller.

PRIMING CHAMBER

Float Removal and Installation

1. Loosen the hose clamp and disconnect the air hose from the prime valve.
2. Remove the four 3/8 in. hex nuts and capscrews from the priming chamber cover.
3. Lift off the priming chamber cover, complete with float linkage and prime valve assemblies.
4. Unscrew the float from the rod set screw.

Reinstallation

1. Screw the float onto the rod and lock with set screw.
2. Replace the priming chamber cover, complete with float linkage and prime valve assemblies.
3. Replace the four 3/8 in. hex nuts and capscrews and tighten against the gasket.
4. Reconnect the air hose and secure with a hose clamp.

Prime Valve Removal and Reinstallation

1. Remove the priming chamber cover, complete with float linkage and prime valve assembly. Refer to [“Float Removal and Installation” on page 60](#).
2. The valve body can be separated from the priming chamber cover by removing the 3/8 in. capscrews for access to the O-ring. No other parts are directly accessible from outside of the cover.

Float Valve Linkage Removal and Installation

There is normally no reason to remove or replace the float valve linkage unless parts have experience damage. In the event that replacement is required, use the following instructions:

1. Separate the linkage frame from the cover by removing the two 5/16 in. capscrews. There may also be stainless flat washers between the frame and cover. (It is important to replace these washers when replacing the frame, as the total mounting distance between the top of the cover and the frame is an essential element in proper priming valve operation.)
2. All elements of the linkage are held in position with clevis pins, side links and cotter pins. To remove any damaged element, straighten and remove the necessary cotter pins and clevis pins.

Note: *The tow actuator arms are very similar in appearance. Before removing either of these parts, make special note of their position and direction in relationship to other assembly parts.*

3. The valve stem assembly may be removed by a similar action of pin removal. Two cross-drilled holes in the lower end of this part, with slightly separated center lines, accommodate accumulated tolerances in the assembled linkage parts. In most instances the drill from which the clevis pin has been removed will be the one to re-use on reassembly.

Linkage Replacement

1. Reverse the previous procedure steps.
2. When the linkage is correctly reassembled and fastened to the cover, the valve seat O-ring should seat firmly when the float ball is raised to its uppermost position, and a 1/8 in. (3 mm) minimum gap should remain between the two actuator arms. If the arms can come together, the valve may not be adequately seating.

Strainer/Baffle

At factory assembly, the strainer is pushed onto the bottom of the priming chamber and is held in place by friction. During normal operation this strainer can drop loose from the cone and rest on the slotted suction spool pipe. This is NOT a problem. Air being evacuated from the suction piping can travel freely through the slots and around the strainer.

Maintenance

There is no regular maintenance to be performed on the separator. However, there are precautions for operation during freezing conditions. In freezing conditions, ensure that there is no ice in the separator chamber to impede the separator float movement. Warm water can be poured over the separator or into the separator chamber through the separator hose connection. When pumping in extremely cold conditions, ice may form on the separator valve seat, preventing closure and allowing water into the compressor. Close observation must be maintained and the pump shut down at the first signs of water coming from the compressor.

Note: *During an initial re-prime, there may be liquid remaining in the suction spool above the slots. This may allow brief misting out the discharge before the prime valve has closed. If at any other time during operation pumpage is seen continuously exhausting from the compressor, the pump should immediately be shut down and the priming chamber cover should be removed. Inspect the float assembly for any impediment to its movement. It should be able to fully close the valve stem assembly to the valve seat. Also check the prime valve for any damage or debris.*

DISCHARGE CHECK VALVE

The discharge check valve enables automatic priming of the pump by closing the air leakage path on the discharge side of the pump. This allows the primer to pull the pump casing vacuum down sufficiently that atmospheric pressure will push the check valve open and allow the flow of liquid through the discharge.

The presence of the check valve, as with any other fitting in the piping system, add resistance (pipe friction) to the total head the pump must overcome during normal operation, and not just while priming for start-up. The amount of this added friction varies with the rate of flow, as well as with pipe size. To determine the extent of the addition for a specific performance point, refer to the flow rate charts beginning on [page 43](#).

If the check valve disc should be prevented from completely closing due to debris or damage, the pump will not re-prime. In such a case it will be necessary to remove the inspection cover and clean out the debris or service the valve.

Maintenance

The check valve requires no scheduled lubrication or maintenance. For service or inspection, the valve can be serviced without disconnecting the inlet or outlet hoses.

Valve inspection - If inspection of the valve is required, follow the disassembly instructions.

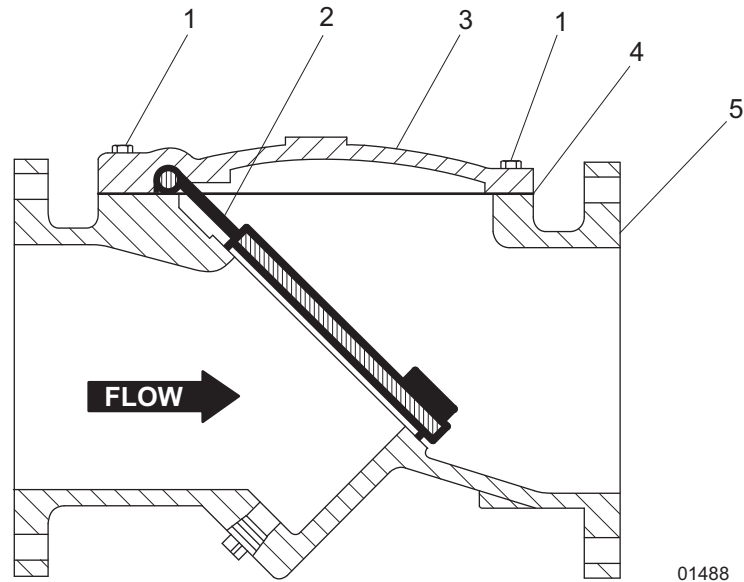

Figure 24 - Discharge Check Valve

- | | |
|----------------|---------------------|
| 1. Cover bolts | 4. Gasket |
| 2. Disc | 5. Check valve body |
| 3. Cover | |

Disassembly

The valve can be disassembled without removing it from the pump.

⚠ WARNING

The line must be drained before removing the cover or pressure may be released, causing bodily harm.

To relieve pressure and drain the pump:

1. Remove the cover bolts from the top cover.
2. Pry the cover loose and lift off the valve body.
3. Remove the disc and inspect for cracks, tears or damage in the rubber sealing surface.
4. Clean and inspect the parts. Replace worn parts as necessary.

Reassembly

All parts must be cleaned. Gasket surfaces should be cleaned with a stiff wire brush in the direction of the serrations or machine marks. Worn parts and gaskets should be replaced during reassembly.

1. Place the disc over the seat with the beaded seating surface directed down.
2. Lay the cover gasket and cover over the bolt holes and disc hinge.
3. Insert the lubricated bolts, noting that the bolts in the hinge area are longer than the others.

- Cover bolts should be tightened to the following specification during assembly.

Table 5 - Bolt Torque Values

Bolt Size	Torque
3/8 in.	24 ft-lbs (33 Nm)
1/2 in.	59 ft-lbs (80 Nm)
5/8 in.	117 ft-lbs (159 Nm)
3/4 in.	205 ft-lbs (278 Nm)

DIAPHRAGM PUMP SYSTEM

Disassembly

- Loosen the clamp and disconnect the air hose from the priming valve.
- Drain the oil from the seal oil reservoir via the line on the lower reservoir connection.
- Disconnect the lower oil line at the reservoir, hold the disconnected end over a container and move the line and container down to below the connected end of the oil line. This will drain the remaining oil from the lines and gland.
- Disconnect the oil lines from the gland and unbolt the gland only if further pump disassembly is planned.
- Remove the bolts and nuts holding the two halves of the vacuum pump belt guard together. Remove the two bolts and nuts holding the guard halves to the vacuum pump support table. Remove the belt guard halves.
- Loosen (do not remove) the four bolts securing the vacuum pump to the support table. The belt is tensioned by means of shims under the vacuum pump. Loosen the support table bolts and insert a large screwdriver or pry bar between the vacuum pump and support table. Lift the vacuum pump enough so that the shims can be removed.
- Lower the vacuum pump to create sufficient slack to remove the belt. Once the belt is removed, the vacuum pump can be completely unbolted and removed if desired.

8. The vacuum pump support table and seal oil reservoir can now be unbolted and removed if desired.

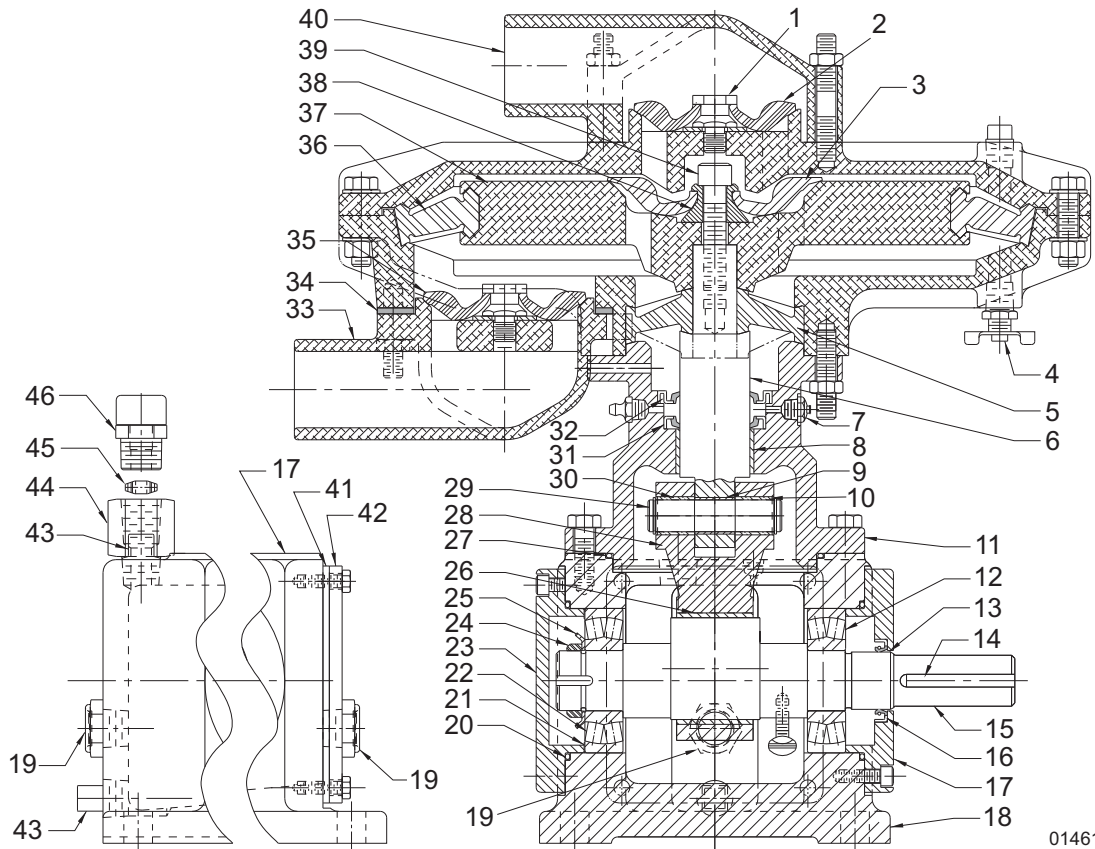

Figure 25 - Diaphragm Vacuum Pump Cross-section

- | | |
|------------------------------|-----------------------------------|
| 1. Valve stud | 24. Locknut |
| 2. Suction and exhaust valve | 25. Lock washer |
| 3. Actuator valve | 26. Crankshaft bearing |
| 4. Stop cock | 27. O-ring (pedestal) |
| 5. Actuator neck seal | 28. Connecting rod |
| 6. Actuator shaft | 29. Fulcrum pin |
| 7. Grease relief valve | 30. Fulcrum pin bearing |
| 8. Actuator shaft bearing | 31. Internal lip seal |
| 9. Pedestal bearing | 32. Wiper lip seal |
| 10. Retaining ring (2) | 33. Suction nozzle |
| 11. Pedestal | 34. Suction nozzle gasket |
| 12. Drive end bearing | 35. Suction and exhaust valve (2) |
| 13. Speed-sleeve location | 36. Actuator seal |
| 14. Shaft key | 37. Actuator |
| 15. Crankshaft | 38. Actuator washer |
| 16. Lip seal | 39. Actuator lock screw |
| 17. Drive end cover | 40. Exhaust nozzle |
| 18. Bearing housing | 41. Inspection plate gasket |
| 19. View gauge (2) | 42. Inspection plate |
| 20. O-ring (bearing cover) | 43. Pipe plug (remove to add oil) |
| 21. Shims | 44. Adapter |
| 22. O.D.E bearing | 45. Breather disc |
| 23. O.D.E. bearing cover | 46. Breather (bearing housing) |

01461

Reassembly

1. Reinstall the vacuum pump support table and oil reservoir.
2. Orient the oil reservoir so that the inlet and outlet ports are on the same side of the pump as the inlet and outlet ports of the gland.
3. Reinstall the oil lines between the gland and reservoir. The upper and lower ports of the gland and reservoir should be connected together.
4. Reinstall the pulley on the pump main shaft. Position the toothed drive belt in the adapter support bracket and install the pulley. Alternately, the pulley can be installed into the SAE adapter support bracket before the belt is installed on the pulley. Reinstall the SAE adapter bracket to the adapter support bracket. Reinstall the engine drive coupling.
5. Place the vacuum pump on the support table and loosely replace the bolts and nuts.
6. Place the drive belt over the pulleys on the main shaft and vacuum pump shaft. Place shims evenly under the vacuum pump mounting until proper belt tension is obtained and tighten the bolts. A load of 3.0 lbs (1.36 kg) applied across the belt at mid-span should give a deflection at that point of 1/8 in. (3.17 mm). Recheck the belt tension after tightening the vacuum pump mounting bolts. The belt need only be tight enough to prevent "jumping" from one tooth to another.
7. Reconnect the air hose between the inlet on the bottom side of the vacuum pump housing and the priming valve nozzle. Make certain that the clamps are properly tightened.

Note: During operation, once the pump is fully primed, no air should be felt exiting the vacuum pump exhaust. Close off the vacuum pump exhaust with the palm of the hand. If air pressure builds, then check all priming chamber to vacuum pump hose connections for leakage.

8. Ensure the drain plugs are replaced and fill the oil reservoir to within 1/2 in. (6.35 mm) of the upper level glass. Check the oil level in the vacuum pump bearing housing and add oil if necessary. The oil level should be visible in the center of the level glass. DO NOT OVERFILL.
9. Once the pump assembly has been remounted to the baseplate, and the couplings between the pump shaft and driver have been reinstalled and aligned, replace the vacuum pump belt guard halves. Re-bolt the halves to each other and then to the support table.
10. Check all bolts for tightness.

SUCTION VALVE REMOVAL AND REPLACEMENT

1. Remove the hose to the priming chamber.
2. Remove the four 3/8 in. nuts.
3. Remove the suction valve elbow and discard the gasket.
4. Lift the valve over the head of the valve stud; do not remove the bolt.
5. Clean the valve chamber and seat.
6. Lubricate the valve stud and push the new valve on over the head of the stud. Be sure to tuck the elastomeric shoulder of the valve completely under the head of the valve stud.
7. Fit the new gasket and replace the suction valve elbow and 3/8 in. nuts.
8. Replace the priming chamber hose and tighten the hose clamp.

ACTUATOR NECK SEAL REMOVAL AND REPLACEMENT

1. Remove the actuator assembly as described in *“Suction Valve Removal and Replacement” on page 65.*
2. Remove the priming chamber hose from the suction nozzle.
3. Remove the four hex nuts holding the lower housing to the pedestal.
4. Remove the vacuum pump lower housing and actuator neck seal.
5. Lubricate the new actuator neck seal and push it into the vacuum pump lower housing.
6. Fit the assembly over the actuator shaft.
7. Orient the vacuum pump inlet suction nozzle to face the priming chamber and replace the four hex nuts.
8. Refit the actuator/seal assembly and remaining components. Refer to *“Suction Valve Removal and Replacement” on page 65.*

CRANKSHAFT REMOVAL AND REPLACEMENT

Removal:

1. Remove the actuator neck seal as described in *“Suction Valve Removal and Replacement” on page 65.*
2. Remove the 1/2 in. NPT drain plug from bearing housing; drain and discard oil.
3. Remove the four 3/8 in. capscrews from the pedestal lower flange.
4. Carefully remove the vacuum pump pedestal complete with seals and linear bearing. Remove and discard the O-ring taking special care not to damage the actuator rod surface.
5. Remove the four 1/4 in. capscrews from the inspection plate.
6. Remove the inspection cover. Remove and discard gasket.
7. Remove the thumbscrew dippers from the crankshaft.
8. Remove the four 1/4 in. capscrews from the O.D.E. bearing cover.
9. Remove the bearing cover and O-ring. Discard the O-ring.
10. Bend back the lock washer tabs and remove the bearing locknut; use ‘C’ spanner SKF REF HN5 or equivalent.
11. Remove the lock washer.
12. Remove the four 1/4 in. capscrews from the drive end bearing cover.
13. Remove the drive end bearing cover complete with lip seal.
14. Remove the O-ring and discard.
15. Carefully pull the shaft from the housing, complete with drive end bearing.
16. Remove the connecting rod actuator shaft assembly and inspect the bushings.
17. Use a bearing puller to remove the bearing from the shaft.

Replacement:

1. On a new replacement shaft, with a zero lead ground lip seal surface, no speed-sleeve is required. On a reinstalled shaft, when surface condition dictates, or on a new shaft with a turned surface, install a speed-sleeve .06-.12 in. (1.52-3.0 mm) past the outside drive end shoulder. Refer to [Figure 25 on page 64](#).
2. Carefully slide the opposite drive end of the shaft and bearing assembly into the drive end of the housing through the con-rod bushing and engage the shaft end in the ODE bearing.
3. Fit the lock washer, engaging locating tab in the shaft groove.
4. Fit the bearing locknut and tighten with 'C' spanner; bend lock washer tab into groove.
5. Replace the appropriate total thickness of shims to leave .007 in. to .010 in. (.177-.254) clearance between the ODE bearing and installed cover.
6. Fit the ODE bearing cover and new O-ring; secure with four 1/4 in. capscrews. Tighten to 10 ft-lbs (13.5 Nm).
7. Fit the drive end bearing cover complete with lip seal and new O-ring. Secure with four 1/4 in. capscrews. Tighten to 10 ft-lbs (13.5 Nm).
8. If the actuator shaft has been disassembled from connecting rod, reassembly with the bushing fulcrum pin and snap rings before continuing.
9. Carefully lower the pedestal, complete with seal O-ring and linear bearing, over the actuator shaft. (Assembly tool [P/N: 52655] is available to assist with reassembly of the pedestal without damage to the lip seals. Contact Generac Technical Service.)
10. Secure the pedestal with the top flat relief properly oriented to clear the inlet nozzle.
11. Refit the actuator neck seal and remaining components. Refer to ["Actuator Neck Seal Removal and Replacement" on page 66](#).
12. Refill the bearing housing with 10W-30 oil. Fill so static oil level is at the center of the sight glass. Do not overfill.

CRANKSHAFT LIP SEAL REMOVAL AND REPLACEMENT

1. Remove the 1/2 in NPT drain plug from the bearing housing. Drain and discard oil.
2. Remove the four 1/4 in. capscrews from the drive end bearing cover.
3. Remove the drive end bearing cover complete with lip seal.
4. Remove and discard the O-ring.
5. Pull the lip seal from the cover and discard.
6. Clean and lubricate the lip seal cavity. Press in the lip seal fully against the shoulder (lip nearest the bearing).
7. Inspect the speed-sleeve; replace if required.
8. Lubricate the shaft sealing surface.
9. Fit the new O-ring on the bearing cover and slide the assembly over the shaft. Align the screw holes.
10. Secure the cover to the bearing housing with four 1/4 in. capscrews. Tighten to 10 ft-lbs (13.5 Nm).

11. Fill the bearing housing with 10W-30 oil to where the static oil level is below the center of the sight glass. Do not overfill.

ROLLER BEARING REMOVAL AND REPLACEMENT

Follow procedures in *“Crankshaft Removal and Replacement” on page 66* and *“Crankshaft Lip Seal Removal and Replacement” on page 67*.

CONNECTING ROD/DRIVE ROD ASSEMBLY

It is recommended that these items be purchased pre-assembled with bearing finish machined and reamed. For removal, refer to *“Crankshaft Removal and Replacement” on page 66* and *“Crankshaft Lip Seal Removal and Replacement” on page 67*.

PEDESTAL BEARING AND SEALS REMOVAL AND REPLACEMENT

1. Remove the vacuum pump pedestal assembly, complete with lip seals, following the steps in *“Crankshaft Removal and Replacement” on page 66*.
2. Remove the seals from the housing.
3. Use a bearing drift to push out the pedestal bearing.
4. Lubricate the new bearing and press it into the housing until the bottom edges of the bearing and housing are flush with one another.
5. Lubricate the seal housing and press in the lower seal (lip nearest to bearing). (Assembly tool [P/N: 52655] is available to assist with re-assembly of the lip seals in pedestal. Contact Generac Technical Service.)
6. Press the wiper seal into the pedestal with wiper lip uppermost.

Replace the pedestal assembly and remaining components, complete with lip seal, following the steps in *“Crankshaft Removal and Replacement” on page 66*. Check the bearing housing oil level daily and add 10W-30 oil as necessary. Fill to the center of the sight glass. Do not overfill.

Every six months or every 1500 hours, drain the bearing housing and refill with fresh 10W-30 oil. If pumpage is seen exhausting from the vacuum pump discharge, shut the pump down and inspect the priming chamber.

STORAGE

The unit is adequately prepared for outside storage prior to shipment. Use the following list of additional suggestions for extended storage.

Extended Storage Preparation

1. Disconnect the battery cables.
2. Store the unit off the ground so no water will accumulate around the equipment.
3. Protect the unit from blowing sand and dirt.
4. Stack no other items on top of the pump/equipment.
5. Protect the unit from the entry of any animals.
6. Periodically rotate shaft to lubricate bearings and protect bearings from brinelling.
7. Protect unit with approved drying agents (Silica Gel).

8. Ensure all bare metal areas are coated with a rust preventative.
9. Inspect unit every four weeks and replace drying agents (Silica Gel) as required, or a minimum of every six months.
10. Keep an inspection record showing dates of inspection with any maintenance performed and condition of drying agents (Silica Gel).
11. Before use ensure that all rust protection has been removed. Also, remove any foreign material that may have accumulated during storage.
12. Before use remove all drying agents (Silica Gel).
13. Drain all water from the main pump piping, including the suction line and discharge line. Remove the volute drain plug and vent plug to empty the pump casing.
14. Verify correct oil level in the engine and seal oil reservoir. Add oil as necessary.
15. Add grease to the main pump bearing frame fittings. Three to six strokes at each fitting with a hand grease gun should be sufficient.
16. Jog the main pump motor for 10 to 15 seconds. Replace all plugs removed for draining.

WINTER STORAGE

Occasional motor starts once every month are recommended. Run the unit until it reaches operating temperature. This will help to replace and maintain a lubricating film on the bearings and operating parts.

Restart Preparation

In installations where winter shutdown and storage is the normal situation, it is recommended that lubricating oil and seal barrier oil be drained and replaced to correct levels before the beginning of each new season.

- Add fresh grease to the main bearing frame and vacuum pump pedestal fittings
- Check all gasketed flanges, especially those on the suction side of the pump, for bolt tightness to eliminate the effect of air leaks on the priming time.

This Page Intentionally Left Blank

Section 5 - Troubleshooting

PUMP TROUBLESHOOTING

Symptom	Possible Cause
No discharge	1,2,3,4,5,7,8,9,10,17,18,19,20,37
Reduced capacity	2,3,4,5,7,8,9,10,11,17,19,20,21,38,39,40,47
Reduced pressure	5,7,8,11,13,18,19,38,39,40,47
Loss of prime	2,3,4,7,10,11,20,21,22,23
Power consumption excessive, engine runs hot	6,12,13,17,18,19,24,33,34,35,36,37,38,41,42,43,44
Vibration and noise	2,4,9,10,14,15,17,26,27,28,29,30,31,32,33,34,35,36,39,40,41,42,43,44,48
Seal: excessive leakage, short life, seal housing overheating	22,23,25,33,34,35,36,41,44,45,46
Bearings: overheating, short life, noise	26,27,28,29,30,31,32,33,34,35,36,41,42,43,44
Pump overheating, seizes	1,8,9,14,33,34,35,36,41,42,43,44
Corrosion, erosion, pitting, oxidation or other loss of material	7,8,11,14,15,16

1. Pump not primed	16. Electrolysis	34. Temperature growth
2. Suction line not filled	17. Impeller obstructed	35. Misalignment
3. Air pocket in suction line	18. Rotation direction wrong	36. Coupling improperly installed
4. Suction inlet or foot valve obstructed, insufficiently submerged, or too small	19. Low speed	37. Impeller installed backwards
5. System head higher than pump design head	20. Air leak into suction line	38. Worn wear rings
6. System head lower than pump design head	21. Air leak through mechanical seal	39. Impeller damage
7. Insufficient Net Positive Suction Head (NPSH)	22. Seal fluid contaminated, hot or insufficient	40. Improper balance (after repair)
8. Parallel pump application is incorrect	23. Seal fluid system not vented	41. Bent shaft
9. Suction pressure to vapor pressure below minimum	24. High speed	42. Excessive thrust
10. Suction lift too high	25. Mechanical seal insufficient	43. Rotational element dragging
11. Excess vapor in pumpage	26. Bearing housing excessively cooled	44. Worn or incorrectly installed bearings
12. Specific gravity of pumpage housing different than design	27. Low oil pressure (oil lube bearings)	45. Mechanical seal not properly set, O-rings damaged or hardened
13. Viscosity of pumpage different than design	28. Improper or poor lubrication	46. Shaft scored at seal
14. Operation at below rated capacity	29. Lubrication defective	47. Volute O-ring
15. Cavitation	30. Dirt in lubrication/bearings	48. Foundation not rigid or settled
	31. Moisture in lubricant/bearing housing	
	32. Lubricant excess	
	33. Pipe strain	

ENGINE FAULT SHUTDOWN TROUBLESHOOTING

Symptom	Possible Cause	Solution
Low oil pressure shutdown	Low oil level	Check oil level, replace as necessary
	Faulty oil pressure sender	Replace oil pressure sender
	Incorrect oil grade	Change engine oil, refer to engine operating manual
	Worn oil pump	Refer to engine operating manual
	Oil leak	Refer to engine operating manual
High temperature shutdown	Low coolant level	Check coolant level, replace as necessary
	Faulty temperature sender	Replace temperature sender
	Coolant leaks	Refer to engine operating manual, replace components as necessary
	Worn water pump	Refer to engine operating manual
Overcrank shutdown	Pump engine will not start	Refer to engine operating manual
Overspeed shutdown	Pump cavitation	Reduce engine speed, lower intake hose
	Air trapped in intake hose	Relocate and/or straighten intake hose
	Intake insufficiently submerged	Lower intake hose
	Air leak in intake hose	Inspect intake hoses and couplings for damage or missing components and seals
	Air leak at pump housing	Inspect gaskets, seals and O-rings at pump intake flange, clean out cover and priming port
No speed signal shutdown	Engine magnetic pickup damaged or misaligned	Inspect magnetic pickup for damage/alignment
Low fuel shutdown	Low fuel level	Refill fuel tank with clean diesel fuel
Low coolant shutdown	Low coolant level	Allow engine to cool. Check coolant level in radiator. Add coolant until it is 3/4 in. (19 mm) below the filler neck

CONTROL SYSTEM TROUBLESHOOTING

Symptom	Possible Cause	Solution
Control system does not perform self test	Tripped overcurrent protection	Correct fault, replace or reset overcurrent protection
	Faulty connection to battery	Correct battery connections
	Faulty control system	Repair or replace control system
Control system shuts down	Engine stop LED illuminated	Correct ECU stop condition, use ECU diagnostics
Display does not display data	Display lost power	Turn on key, verify display plugged into harness
	Engine source address incorrect	Change engine address in <i>Configuration</i>
	Display address incorrect	Change display address to 40 (default)
	Display configuration problem	Reset display using <i>Restore Defaults</i>
	CANbus failure	Check CANbus (Refer to <i>Testing CANbus</i>)
	ECU not sending data	Repair or replace ECU
Engine will not crank	Fuel level/pressure low (SPN 524057)	Check fuel level Check if fuel supply line is loose Prime fuel system: Turn key to Start position. Let pump run for 10-15 seconds. (May need to repeat.)

DIAGNOSTIC TROUBLE CODES (DTS)

CANbus Diagnostic Trouble Codes are a pair of numbers; the Suspect Parameter Number (SPN) and Failure Mode Identifier (FMI). The SPN indicates the faulting subsystem and the FMI identifies the type of failure.

SPN Codes

Standard SPN codes are defined by SAE J1939-71. Not all standard codes are provided by ECUs. Manufacturers may add additional SPN codes beyond the codes identified in J1939-71. Contact a Deutz dealer or Generac Technical Service for more information.

Table 6 - Typical SPN Codes

SPN	Description
51	Throttle Position
91	Accelerator Pedal Position
94	Fuel Delivery Pressure
98	Engine Oil Level
100	Engine Oil Pressure
110	Engine Coolant Temperature

Table 6 - Typical SPN Codes

SPN	Description
111	Coolant Level

FMI Codes

FMI codes are defined by SAE J1939-71. Refer to ECU documentation for correct interpretation of FMI codes for a specific SPN.

Table 7 - FMI Codes

FMI	Description
0	Data valid but above normal operational range
1	Data valid but below normal operational range
2	Data erratic, intermittent or incorrect
3	Voltage above normal or shorted high
4	Voltage below normal or shorted low
5	Current below normal or open circuit
6	Current above normal or grounded circuit
7	Mechanical system not responding properly
8	Abnormal frequency, pulse width or period
9	Abnormal update rate
10	Abnormal rate of change
11	Failure mode not identifiable
12	Bad intelligent device or component
13	Out of calibration
14	Special instructions
15	Data valid but above normal operational range (least severe)
16	Data valid but above normal operational range (moderately severe)
17	Data valid but below normal operational range (least severe)
18	Data valid but below normal operational range (moderately severe)
19	Received network data in error
20-30	Reserved for future assignment
31	Not available or condition exists

Section 6 - Wiring Diagrams

DC WIRING DIAGRAM

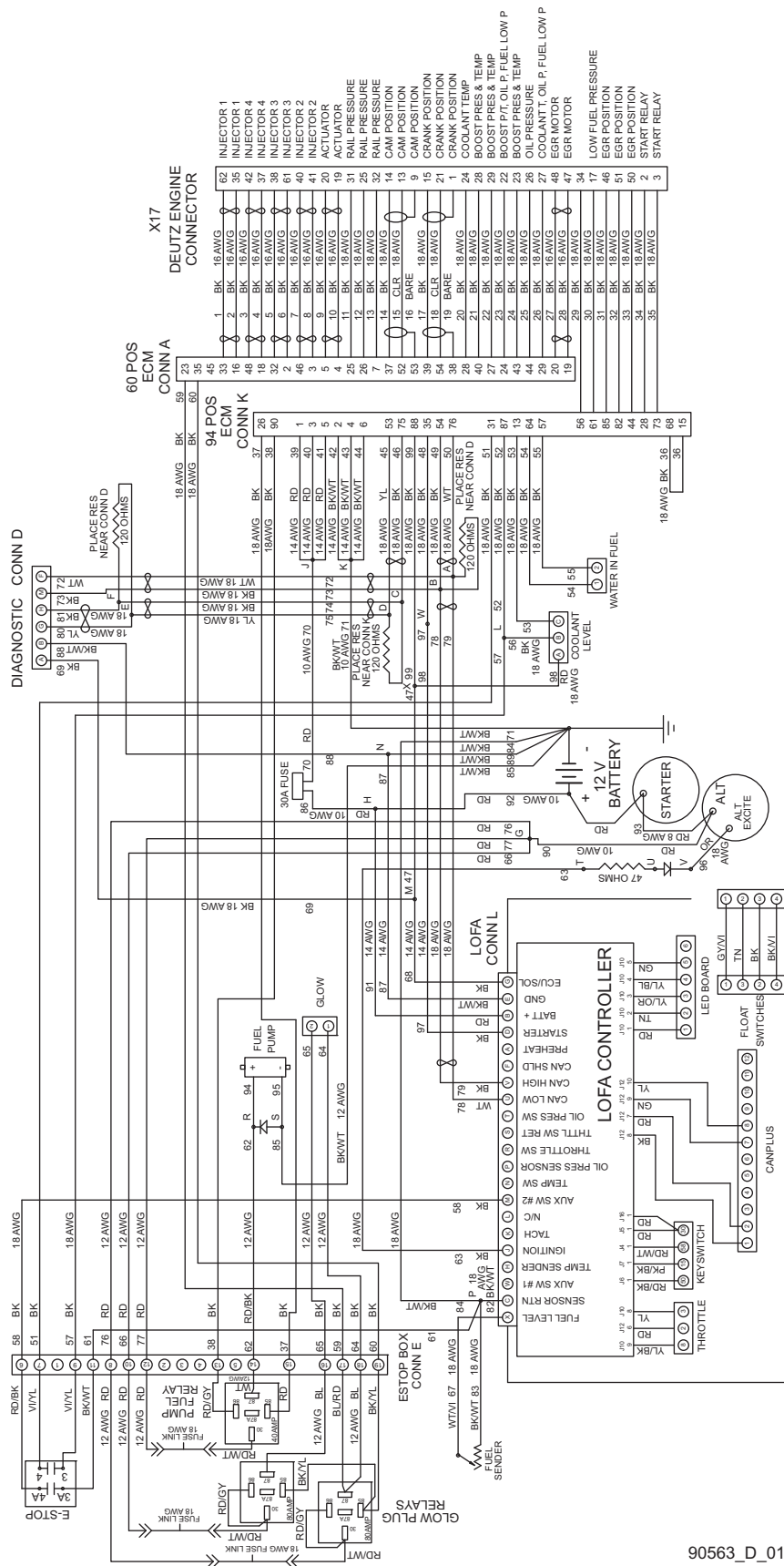

90563_D_01.26.15

TRAILER LIGHTS WIRING DIAGRAM

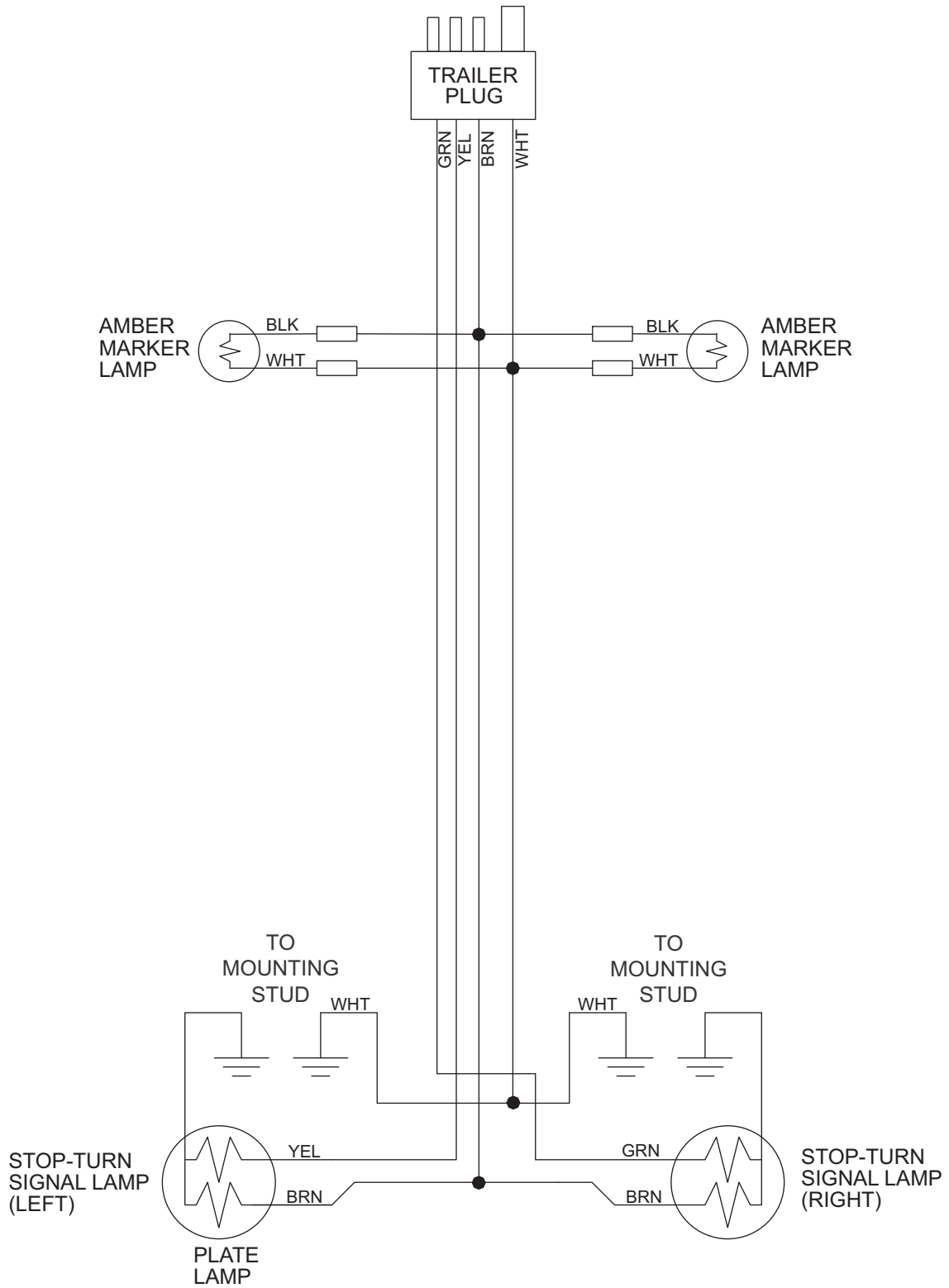

90228_ORG_05.09.12

