

VENT-FREE GAS LOG SET

MODEL # VFL-CY24DR
VFL-HT24DR
VFL-CY30DR
VFL-HT30DR



Dual Fuel



OMNI-Test Laboratories, Inc.

0418GL011S

ANSI Z21.11.2-2013
ANSI Z21.60-2012

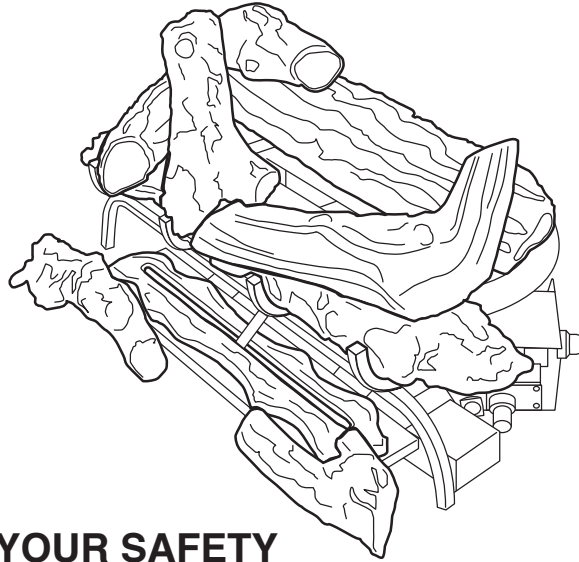

⚠ WARNING: This appliance is equipped for (Natural and Propane) gas. Field conversion is not permitted other than between natural or propane gases.

⚠ CAUTION - FOR YOUR SAFETY

⚠ WARNING: IF THE INFORMATION IN THIS MANUAL IS NOT FOLLOWED EXACTLY, A FIRE OR EXPLOSION MAY RESULT CAUSING PROPERTY DAMAGE, PERSONAL INJURY OR LOSS OF LIFE.

- Do not store or use gasoline or other flammable vapors and liquids in vicinity of this or any other appliance.

WHAT TO DO IF YOU SMELL GAS

- Do not try to light any appliance.
 - Do not touch any electrical switch; do not use any phone in your building.
 - Immediately call your gas supplier from a neighbor's phone. Follow the gas supplier's instructions.
 - If you cannot reach your gas supplier, call the fire department.
- Installation and service must be performed by a qualified installer, service agency or the gas supplier.

This is an unvented gas-fired heater. It uses air (oxygen) from the room in which it is installed. Provisions for adequate combustion and ventilation air must be provided. Refer to Air For Combustion and Ventilation section on page 8 of this manual.

**INSTALLER: Leave this manual with the appliance.
CONSUMER: Retain this manual for future reference.**

This appliance may be installed in an aftermarket, permanently located manufactured (mobile) home, where not prohibited by local codes. This appliance is only for use with propane or natural gas. This appliance is equipped with a simple means to switch between propane and natural gas. Field conversion by any other means including the use of a kit is not permitted.



Questions, problems, missing parts? Before returning to your retailer, call our customer service department at 1-877-447-4768, 8:30 a.m. – 4:30 p.m., CST, Monday – Friday or email us at customerservice@ghpgroupinc.com.

80-10-231 - 2015-12-02

TABLE OF CONTENTS

Specifications	2
Important Safety Information	3
Product Identification	5
Product Features	6
Preparing for Installation.....	7
Installation	10
Unpacking.....	15
Log Assembly	21
Operation.....	23
Remote Control Operation.....	25
Care and Maintenance	32
Troubleshooting	34
Replacement Parts.....	37
Accessories	37
Warranty	38

⚠ WARNING: Read the Installation & Operating Instructions before using this appliance.

IMPORTANT: Read all instructions and warnings carefully before starting installation. Failure to follow these instructions may result in possible injury to persons or a fire hazard and will void the warranty.

ITEM	VFL-CY24DR		VFL-CY30DR	
	VFL-HT24DR		VFL-HT30DR	
Input Rating	33,000 BTU/Hr		33,000 BTU/Hr	
Gas Type	Natural	LP/Propane	Natural	LP/Propane
Ignition	Electronic Piezo	Electronic Piezo	Electronic Piezo	Electronic Piezo
Manifold Pressure	4.5 in. W.C.	10 in. W.C.	4.5 in. W.C.	10 in. W.C.
Inlet Gas Pressure	*For purposes of input adjustment			
Maximum	7 in. W.C.	14 in. W.C.	7 in. W.C.	14 in. W.C.
Minimum*	5.5 in. W.C.	11 in. W.C.	5.5 in. W.C.	11 in. W.C.

WRONG FUEL SHUT DOWN SYSTEM

This heater is equipped with a pressure activated dual circuit that will not allow the main burner to ignite if the incorrect fuel is installed. Inlet gas pressures, listed on page 2 of this Owner's Manual, must be correct for this system to work reliably. Excessive NG inlet gas pressure will activate the "wrong fuel shut down system" and the heater will not light.

SERVICE HINTS

When Gas Pressure Is Too Low

- pilot will not stay lit
- burners will have delayed ignition
- heater will not produce specified heat
- for propane/LP units, propane/LP gas supply may be low

You may feel your gas pressure is too low. If so, contact your local natural or propane/LP gas supplier.

IMPORTANT SAFETY INFORMATION

IMPORTANT: Read this owner's manual carefully and completely before trying to assemble, operate, or service this heater. Improper use of this heater can cause serious injury or death from burns, fire, explosion, electrical shock, and carbon monoxide poisoning.

Only a qualified installer, service agent, or local gas supplier may install and service this product.

 **WARNING:** Do not store or use gasoline or other flammable vapors or liquids in the vicinity of this or any other appliance.

 **WARNING:** This appliance can be used with propane or natural gas. It is shipped from the factory adjusted for use with propane.

CARBON MONOXIDE POISONING: Early signs of carbon monoxide poisoning resemble the flu with headaches, dizziness, or nausea. If you have these signs, the heater may not be working properly. Get fresh air immediately! Have heater serviced. Some people are more affected by carbon monoxide than others. These include pregnant women, people with heart or lung disease, people who are anemic, those under the influence of alcohol, and those living in high altitudes.

NATURAL AND PROPANE/LP GAS: Natural and Propane/LP gases are odorless. An odor-making agent is added to the gas. The odor helps you detect a gas leak. However, the odor added to the gas can fade. Gas may be present even though no odor exists. Make certain you read and understand all warnings. Keep this manual for reference. It is your guide to operating this heater safely.

WARNING:

- Due to high temperatures, locate this appliance out of traffic and away from furniture and draperies.
- Heater becomes very hot when operating. Keep children and adults away from hot surfaces to avoid burns or clothing ignition. Heater will remain hot for a time after shutoff. Allow surfaces to cool before touching.
- Carefully supervise young children when they are in the room with the heater.
- Do not place clothing or other flammable material on or near the appliance. Never place any objects in the heater.
- Installation and repair should be done by a qualified service person. The appliance should be inspected before use and at least annually by a professional service person. More frequent cleaning may be required due to excessive lint from carpeting, bedding material, etc. It is imperative that control compartments, burners and circulating air passageways of the appliance be kept clean.
- Any change to this heater or its controls can be dangerous.
- Do not use any accessories not approved for use with this heater.
- Keep the appliance clear and free from combustible materials, gasoline, and other flammable vapors and liquids.
- This appliance is intended for supplemental heating.

CALIFORNIA PROPOSITION 65

Fuels used in gas or oil fired appliances and the products of combustion of such fuels contain chemicals known to the state of California to cause cancer, birth defects or other reproductive harm. This product contains chemicals, including lead and lead compounds, known to the state of California to cause cancer, birth defects or other reproductive harm. **Wash hands after handling.**

SAFETY INFORMATION

1. This appliance is only for use with the type of gas indicated on the rating plate. This appliance is not convertible for use with other gases.
2. Do not place propane/LP supply tank(s) inside any structure. Locate propane/LP supply tank(s) outdoors.
3. If you smell gas
 - shut off gas supply
 - do not try to light any appliance
 - do not touch any electrical switch; do not use any phone in your building
 - immediately call your gas supplier from a neighbor's phone. Follow the gas supplier's instructions
 - if you cannot reach your gas supplier, call the fire department
4. This heater shall not be installed in a bedroom or bathroom.
5. Do not use this heater as a wood-burning heater. Use only the logs provided with the heater.
6. Do not add extra logs or ornaments such as pine cones, vermiculite or rock wool. Using these added items can cause sooting. Do not add lava rock inside the heater; only around the outside of the heater.
7. This heater is designed to be smokeless. If logs ever appear to smoke, turn off heater and call a qualified service person. Note: During initial operation, slight smoking could occur due to log curing and heater burning manufacturing residues.
8. To prevent the creation of soot, follow the instructions in Cleaning and Maintenance, page 32-33.
9. Before using furniture polish, wax, carpet cleaner or similar products, turn heater off. If heated, the vapors from these products may create a white powder residue within burner box or on adjacent walls or furniture.
10. This heater needs fresh air ventilation to run properly. This heater has an Oxygen Depletion Sensing (ODS) safety shutoff system. The ODS shuts down the heater if not enough fresh air is available. See Air for Combustion and Ventilation, page 9. If heater keeps shutting off, see Troubleshooting, page 34.
11. Do not run heater
 - where flammable liquids or vapors are used or stored.
 - under dusty conditions.
12. Do not use this heater to cook food or burn paper or other objects.
13. Never place any objects in the heater or on logs.
14. Do not use heater if any part has been under water. Immediately call a qualified service technician to inspect the room heater and to replace any part of the control system and any gas control which has been under water.
15. Only a qualified service person should service and repair heater.
16. Operating heater above elevations of 4,500 feet could cause pilot outage.
17. Do not operate heater if log is broken. Do not operate heater if log is chipped (dime-sized or larger).
18. To prevent performance problems, do not use propane/LP fuel tank of less than 100 lb. capacity.
19. Provide adequate clearances around air openings.
20. A fireplace screen must be in place when the heater is operating.

QUALIFIED INSTALLING AGENCY

Only a qualified agency should install and replace gas piping, gas utilization equipment or accessories, and repair and equipment servicing. The term "qualified agency" means any individual, firm, corporation, or company that either in person or through a representative is engaged in and is responsible for:

- a) Installing, testing, or replacing gas piping or
- b) Connecting, installing, testing, repairing, or servicing equipment; that is experienced in such work; that is familiar with all precautions required; and that has complied with all the requirements of the authority having jurisdiction.

PRODUCT IDENTIFICATION

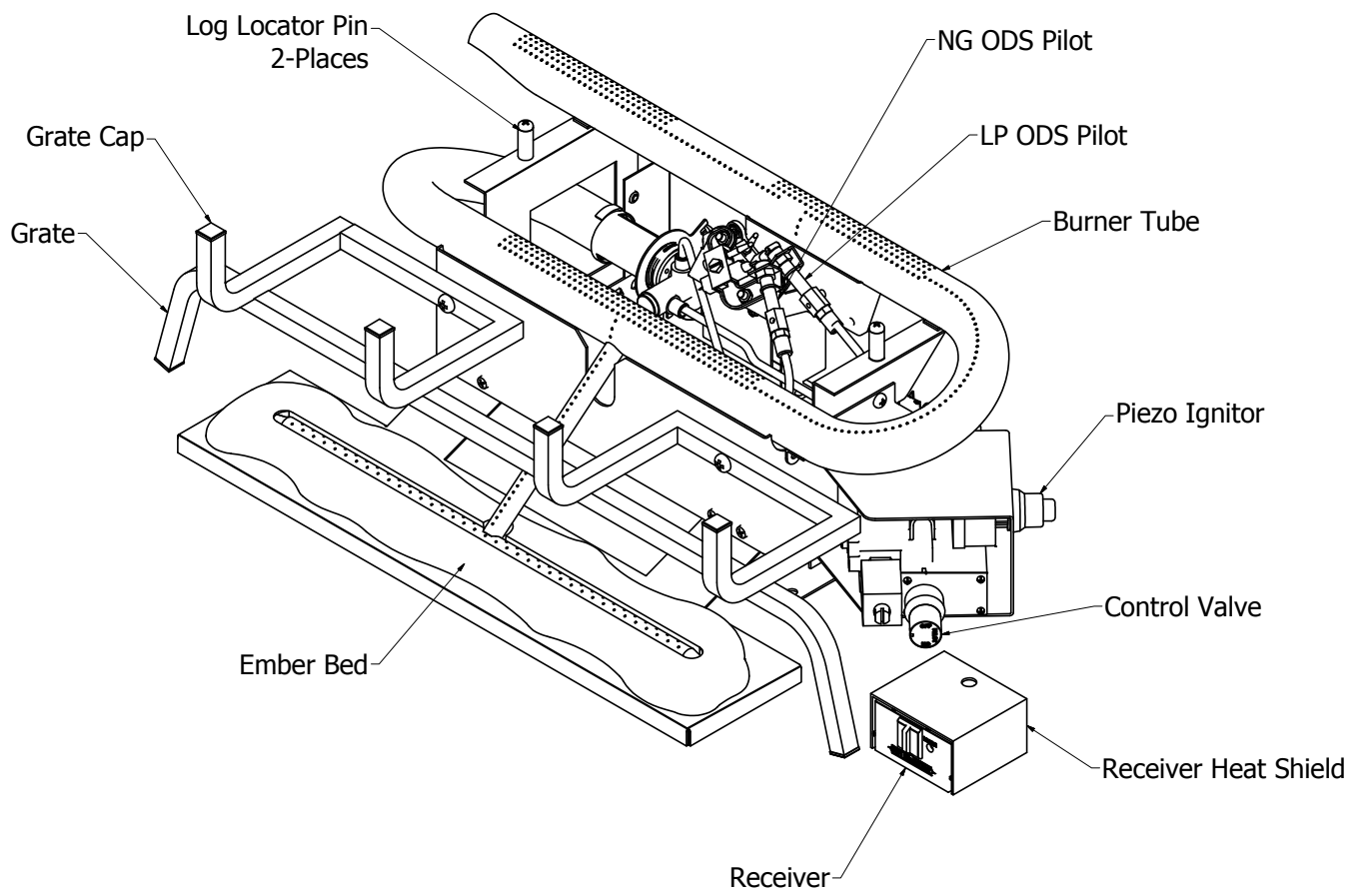

PRODUCT FEATURES

This log set has been tested and approved to ANSI Z21.11.2-2013 standard for Unvented Heaters and can be operated with the flue damper closed. State and local codes in some areas prohibit the use of vent-free heaters.

DUAL FUEL CAPABILITY

Your heater is equipped to operate on either propane or natural gas. The heater is shipped from the factory ready for connecting to propane. The heater can easily be changed to natural gas by having your qualified installer follow the instructions on page 16 and the markings on the heater.

SAFETY PILOT

This heater has a pilot with an Oxygen Depletion Sensing (ODS) safety shutoff system. The ODS/pilot shuts off the heater if there is not enough fresh air and cuts off main burner gas in the event of flame out.

ELECTRIC PUSH BUTTON IGNITION SYSTEM

This heater is equipped with an electronic piezo control system. This system requires one AAA battery (provided).

THERMOSTAT HEAT CONTROL

The control automatically cycles the burner on and off to maintain a desired room temperature (See page 24). When used as a vented decorative appliance, use of the thermostat function is prohibited, operate manually only.

State of Massachusetts: The installation must be made by a licensed plumber or gas fitter in the Commonwealth of Massachusetts. Sellers of unvented propane or natural gas-fired supplemental room heaters shall provide to each purchaser a copy of 527 CMR 30 upon sale of the unit.

In the State of Massachusetts, unvented propane or natural gas-fired space heaters shall be prohibited in bedrooms and bathrooms.

In the State of Massachusetts the gas cock must be a T-handle type. The State of Massachusetts requires that a flexible appliance connector cannot exceed three feet in length.

LOCAL CODES

Install and use heater with care. Follow all codes. In the absence of local codes, use the latest edition of The National Fuel Gas Code, ANSI Z223.1, also known as NFPA 54*.

*Available from:

American National Standard Institute, Inc.
1430 Broadway
New York, NY 10018

National Fire Protection Association, Inc.
1 Batterymarch Park
Quincy, MA 02269-9101

This heater is designed for vent-free operation. State and local codes in some areas prohibit the use of vent-free heaters.

The installation of appliances designed for manufactured home (U.S. only) or mobile home installation must conform with the *Standard CAN/CSA Z240 MH, Mobile Housing*, in Canada, or with the *Manufactured Home Construction and Safety Standard, Title 24 CFR, Part 3280*, in the United States, or when such a standard is not applicable, *ANSI/NCSBCS A225.1/NFPA 501A, Manufactured Home Installations Standard*.

PREPARING FOR INSTALLATION

WATER VAPOR: A BY-PRODUCT OF UNVENTED ROOM HEATERS

Water vapor is a by-product of gas combustion. An unvented room heater produces approximately one (1) ounce (30 mL) of water for every 1,000 BTUs (.3 kw) of gas input per hour. An unvented room heater is recommended as a supplemental heater (a room) rather than a primary heat source (an entire house). In most supplemental heat applications, the water vapor does not create a problem. In most applications, the water vapor enhances the low humidity atmosphere experienced during cold weather.

The following steps will help ensure that water vapor does not become a problem:

1. Be sure the heater is the proper size for the application, including adequate combustion air and circulation air.
2. If there is high humidity, a dehumidifier may be used to help lower the water vapor content of the air.
3. Do not use an unvented room heater as the primary heat source.

AIR FOR COMBUSTION AND VENTILATION

This heater shall not be installed in a room or space unless the required volume of indoor combustion air is provided by the method described in the ***Nation Fuel Gas Code, ANSI Z223.1/NFPA 54***, the ***International Fuel Gas Code***, or applicable local codes.

PRODUCING ADEQUATE VENTILATION

All spaces in homes fall into one of the three following ventilation classifications:

1. Unusually Tight Construction
2. Unconfined Space
3. Confined Space

The information on pages 8-10 will help you classify your space and provide adequate ventilation.

Confined and Unconfined Space

A confined space as a space whose volume is less than 50 cu. ft. per 1,000 BTU/hr (4.8 m³ per kw) of the aggregate input rating of all appliances installed in that space and an unconfined space as a space whose volume is not less than 50 cu. ft. per 1,000 BTU/hr (4.8 m³ per kw) of the aggregate input rating of all appliances installed in that space. Rooms connecting directly with the space in which the appliances are installed*, through openings not furnished with doors, are considered a part of the unconfined space.

This heater shall not be installed in a confined space or unusually tight construction unless provisions are provided for adequate combustion and ventilation air.

* Adjoining rooms are connecting only if there are doorless passageways or ventilation grills between them.

Unusually Tight Construction

The air that leaks around doors and windows may provide enough fresh air for combustion and ventilation. However, in buildings of unusually tight construction, you must provide additional fresh air.

Unusually tight construction is defined as construction where:

- a) walls and ceilings exposed to the outside atmosphere have a continuous water vapor retarder with a rating of one perm (6x10⁻¹¹kg per pa-sec-m²) or less with openings gasketed or sealed and
- b) weather stripping has been added on windows that can be opened and on doors and
- c) caulking or sealants are applied to areas such as joints around window and door frames, between sole plates and floors, between wall-ceiling joints, between wall panels, at penetrations for plumbing, electrical, and gas lines, and at other openings.

If your home meets all of the three criteria above, you must provide additional fresh air. See "Ventilation Air From Outdoors" (page 9). If your home does not meet all of the three criteria above, proceed to "Determining Fresh-Air Flow For Heater Location".

PREPARING FOR INSTALLATION

DETERMINING FRESH-AIR FLOW FOR HEATER LOCATION

Determining if You Have a Confined or Unconfined Space

Use this worksheet to determine if you have a confined or unconfined space.

Space: Includes the room in which you will install heater plus any adjoining rooms with doorless passageways or ventilation grills between the rooms.

1. Determine the volume of the space $\text{Length} \times \text{Width} \times \text{Height} = \text{cu. ft. (volume of space)}$

Example: Space size 20 ft. (length) \times 16 ft.(width) \times 8 ft. (ceiling height) = 2560 cu. ft. (volume of space)

If additional ventilation to adjoining room is supplied with grills or openings, add the volume of these rooms to the total volume of the space.

2. Divide the space volume by 50 cu. ft. to determine the maximum BTU/hr the space can support.

_____ (volume of space) \div 50 cu. ft.= (Maximum BTU/hr the space can support)

Example: 2560 cu. ft. (volume of space) \div 50 cu. ft. = 51.2 or 51,200 (maximum BTU/hr the space can support)

3. Add the BTU/hr of all fuel burning appliances in the space.

Vent-free heater _____ BTU/hr

Gas water heater* _____ BTU/hr

Gas furnace _____ BTU/hr

Vented gas heater _____ BTU/hr Example:

Gas heater logs _____ BTU/hr Gas water heater 30,000 BTU/hr

Other gas appliances*+ _____ BTU/hr Vent-free heater + 26,000 BTU/hr

Total = _____ BTU/hr Total = 56,000 BTU/hr

*Do not include direct-vent gas appliances. Direct-vent draws combustion air from the outdoors and vents to the outdoors.

4. Compare the maximum BTU/hr the space can support with the actual amount of BTU/hr used.

_____ BTU/hr (maximum the space can support)

_____ BTU/hr (actual amount of BTU/hr used).

Example : 51,200 BTU/hr (maximum the space can support) 56,000 BTU/hr (actual amount of BTU/hr used)

The space in the above example is a confined space because the actual BTU/hr used is more than the maximum BTU/hr the space can support.

You must provide additional fresh air. Your options are as follows:

- Rework worksheet, adding the space of an adjoining room. If the extra space provides an unconfined space, remove door to adjoining room or add ventilation grills between rooms. See "Ventilation Air From Inside Building," page 9.
- Vent room directly to the outdoors. See "Ventilation Air From Outdoors", page 9.
- Install a lower BTU/hr heater if lower BTU/hr size makes room unconfined. If the actual BTU/hr used is less than the maximum BTU/hr the space can support, the space is an unconfined space. You will need no additional fresh air ventilation.

PREPARING FOR INSTALLATION

⚠ WARNING: If the area in which the heater may be operated does not meet the required volume for indoor combustion air, combustion and ventilation air shall be provided by one of the methods described in the NATIONAL FUEL GAS CODE, ANSI Z223.1/NFPA 54, the INTERNATIONAL FUEL GAS CODE, or applicable local codes.

Ventilation Air From Inside Building

This fresh air would come from adjoining unconfined space. When ventilating to an adjoining unconfined space, you must provide two permanent openings: one within 12 in. of the wall connecting the two spaces (see options 1 and 2, Fig. 1). You can also remove door into adjoining room (see option 3, Fig. 1). Follow the National Fuel Gas Code NFPA 54/ANS Z223.1. Air for Combustion and Ventilation for required size of ventilation grills or ducts.

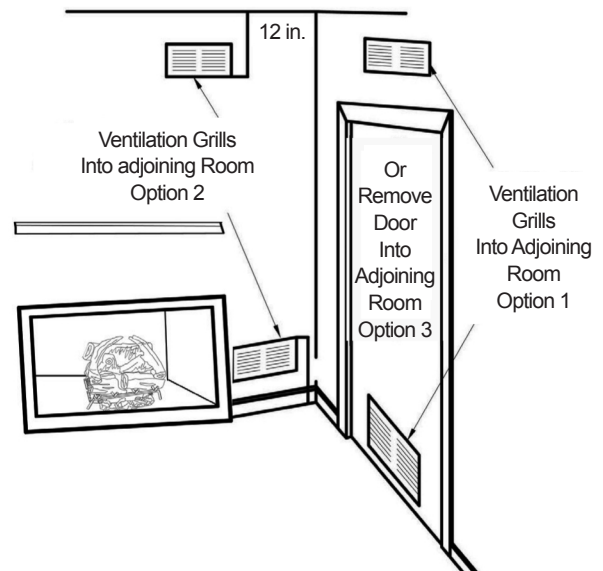

Fig. 1 - Ventilation Air from Inside Building

Ventilation Air From Outdoors

Provide extra fresh air by using ventilation grills or duct. You must provide two permanent openings: one within 12 in. of the ceiling and one within 12 in. of the floor. Connect these items directly to the outdoors or spaces open to the outdoors. These spaces include attics and crawl spaces. Follow the National Fuel Gas Code NFPA 54/ANS Z223.1. Air for Combustion and Ventilation for required size of ventilation grills or ducts.

IMPORTANT: Do not provide openings for inlet or outlet air into attic if attic has a thermostat-controlled power vent. Heated air entering the attic will activate the power vent. Rework worksheet, adding the space of the adjoining unconfined space. The combined spaces must have enough fresh air to supply all appliances in both spaces.

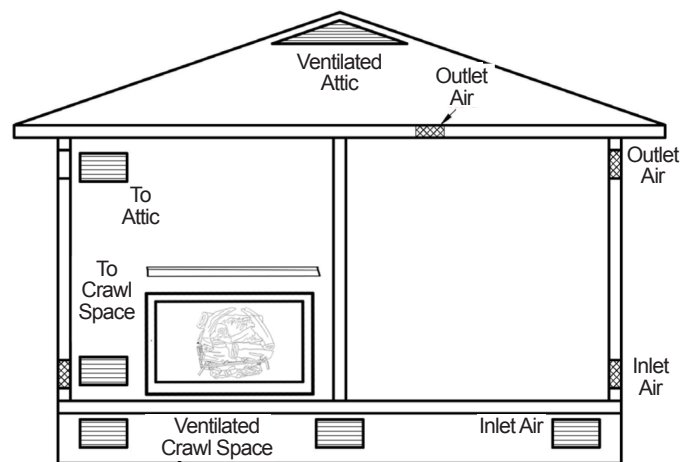

Fig. 2 - Ventilation Air from Outdoors

INSTALLATION

⚠ WARNING: Do not attempt to access or change the setting of the fuel selection means.

Access to and adjustment of the fuel selection means must only be performed by a qualified service person when connecting this appliance to a specified fuel supply at the time of installation.

Change of the selector setting to other than the fuel type specified at the time of installation could damage this appliance and render it inoperable.

The installer shall replace the access cover before completing the installation and operating this appliance.

⚠ NOTICE: This heater is intended for use as supplemental heat. Use this heater along with your primary heating system. Do not install this heater as your primary heat source. If you have a central heating system, you may run system's circulating blower while using heater. This will help circulate the heat throughout the house.

⚠ WARNING: A qualified technician must install heater. Follow all local codes.

⚠ WARNING: Never install the heater:

- in a bedroom or bathroom
- in a recreational vehicle
- where curtains, furniture, clothing, or other flammable objects are less than 42 in. from the front, top or sides of the heater.
- in high traffic areas
- in windy or drafty areas

CAUTION: This heater creates warm air currents. These currents move heat to wall surfaces next to heater. Installing heater next to vinyl or cloth wall coverings or operating heater where impurities (such as tobacco smoke, aromatic candles, cleaning fluids, oil or kerosene lamps, etc.) in the air exist, may cause walls to discolor.

⚠ WARNING: Any glass doors shall be fully opened when the appliance is in operation.

⚠ WARNING: Before installing in a solid-fuel burning fireplace, the chimney flue and firebox must be cleaned of soot, creosote, ashes and loose paint by a qualified chimney cleaner.

⚠ WARNING: Do not allow fans to blow directly into the fireplace. Avoid any drafts that alter burner flame patterns.

⚠ WARNING: Do not use a blower insert, heat exchanger insert or other accessory not approved for use with this heater.

IMPORTANT: Vent-free heaters add moisture to the air. Although this is beneficial, installing heater in rooms without enough ventilation air may cause mildew to form from too much moisture. See Air for Combustion and Ventilation, pages 8 through 10.

CHECK GAS TYPE

Be sure your gas supply is right for your heater.

NOTICE: State or local codes may only allow operation of this appliance in a vented configuration. Check your state or local codes.

⚠ WARNING: This appliance is designed for installation in only a solid-fuel burning masonry or UL 127 factory-built fireplace or in a listed ventless firebox enclosure. Exception: DO NOT install this appliance in a factory-built fireplace that includes instructions stating it has not been tested or should not be used with unvented gas logs.

⚠ WARNING: Solid-fuels shall not be burned in a fireplace in which an unvented room heater is installed.

⚠ WARNING: Any outside air ducts and/or ash dumps in the fireplace shall be permanently closed at time of appliance installation.

INSTALLATION

CHECK GAS TYPE

Make sure your gas supply is correct for your log set. If supply is not correct, do not install heater. Call dealer where you purchased heater for proper gas log set.

LOG SIZING REQUIREMENTS

Log Size	Minimum Firebox Size			
	Height	Depth	Front Width	Rear Width
24 in.	24 in.	15 in.	32 in.	22 in.
30 in.	24 in.	15 in.	36 in.	24 in.

Heater CLEARANCES

- ⚠ CAUTION:** If you install the heater in a home garage
- heater pilot and burner must be at least 18" above floor.
 - locate heater where moving vehicle will not hit it.

For convenience and efficiency, install heater

- where there is easy access for operation, inspection and service
- in coldest part of room
- If this appliance is to be installed directly on carpeting, tile or other combustable material, other than wood flooring, the appliance must be installed on a metal or wood panel extending the full width and depth of the appliance.

Minimum Clearances For Side Combustible Material, Side Wall and Ceiling

A. Clearances from the side of the heater cabinet to any combustible material and wall should follow diagram in Figure 2.5.

B. Clearances from the top of the heater opening to the ceiling should not be less than 36".

- ⚠ WARNING:** Maintain the minimum clearances. If possible, provide greater clearances from the floor, ceiling, and adjoining wall than required.

Fig. 2.5

Minimum Fireplace Clearance to Combustible Materials		
Log size	Side wall	Ceiling
24 in.	16 in.	36 in.
30 in.	16 in.	36 in.

- ⚠ WARNING:** Seal any fresh air vents or ash clean-out doors located on the floor or wall of fire place to prevent drafting caused by pilot outage or sooting. Use a heat-resistant sealant. Do not seal chimney flue damper.

INSTALLATION

MINIMUM NONCOMBUSTIBLE MATERIAL CLEARANCE If Not Using Mantel

You must have noncombustible material(s) above the fireplace opening. Noncombustible materials (such as slate, marble, tile, etc.) must be at least 1/2 in. thick. With sheet metal, you must have noncombustible material behind it, such as a noncombustible fireplace hood accessory. See Fig. 4.

NOTICE: This heater may be used as a vented product. If so, you must always operate log set with chimney flue damper open. If running log set with damper open, noncombustible material above fireplace opening is not needed. Go to Installing Damper Clamp Accessory for Vented Operation, page 14. When used as a vented decorative appliance, use of the thermostat function is prohibited, operate manually only.

Fig. 3 - Minimum Clearance for Combustible to Wall

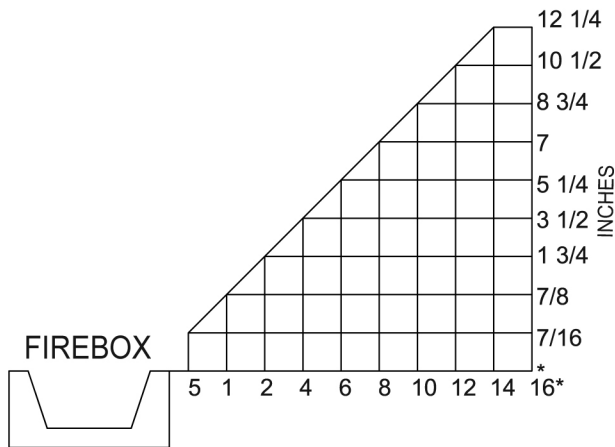
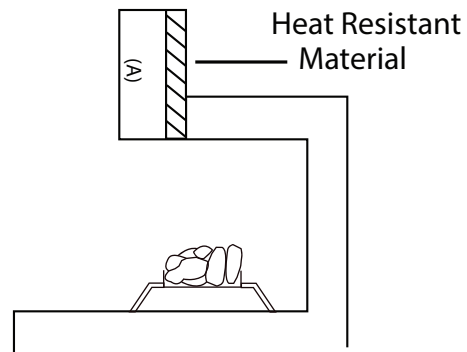

Fig. 4 - Heat resistant material (slate, marble, tile, etc.) above fireplace



If Using Mantel

You must have noncombustible material(s) (such as slate, marble, tile, etc.) at least 1/2 in. thick. With sheet metal, you must have noncombustible material behind it. Noncombustible material must extend at least 8 inches up. If noncombustible material is less than 12 in., you must install the fireplace hood accessory. Even if noncombustible material is more than 12 in., you may need the hood accessory to deflect heat away from mantel shelf. See Fig. 3 and 4 for minimum clearances requirements.

IMPORTANT: If these minimum clearances are not met, you must operate heater with chimney flue damper open. Go to "Installing Damper Clamp Accessory for Vented Operation," page 14.

INSTALLATION

MANTEL CLEARANCES

In addition to meeting noncombustible material clearances, you must also meet required clearances between fireplace opening and mantel shelf. If the clearances listed below are not met, you will need a hood.

Determining Mantel Clearances

If you meet minimum clearance requirements between mantel shelf and top of fireplace opening, a hood is not necessary (see Fig. 5).

Noncombustible Material Distance	Requirements for Safe Installation
8 in. or more	Noncombustible material okay.
Less than 8 in.	Noncombustible material must be extended to at least 8 in. See between 8 in. and 12 in. above. If you can not extend material, you must operate heater with flue damper open.

Determining Minimum Mantel Clearance When Using a Hood

If minimum clearances in Fig. 6 are not met, you must have a hood. When using a hood there are still certain minimum mantel clearances required. Follow minimum clearances shown in Fig. 6 when using a hood.

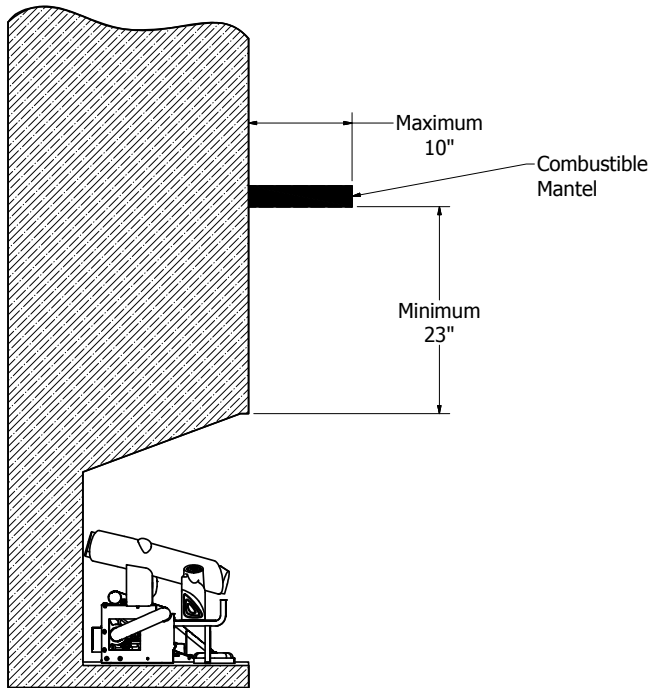

Fig. 5

Closed Flue Mantel Clearances
Without Hood

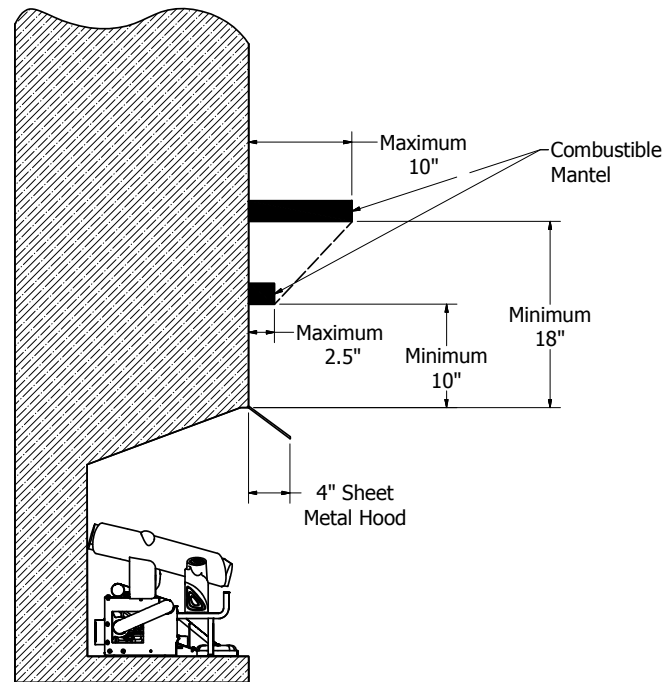

Fig. 6

Closed Flue Mantel Clearances
With Hood

NOTICE: Surface temperature of adjacent walls and mantels become hot during operation. Walls and mantels above the firebox may become too hot to touch. If installed properly, these temperatures meet the requirement of the national product standard. Follow all minimum clearances shown in this manual.

NOTICE: If your installation does not meet the minimum clearances shown, you must do one of the following: Operate the logs with the flue damper open only. Raise the mantel to an acceptable height.

INSTALLATION

FLOOR CLEARANCES

- a) If installing appliance on floor level, you must maintain the minimum distance of 14 in. to combustibles (see Fig. 7).
- b) If combustible materials are less than 14 in. to the fireplace, you must install appliance at least 5 in. above the combustible flooring (see Fig. 8).

Fig. 8 - Minimum fireplace clearances above combustible flooring

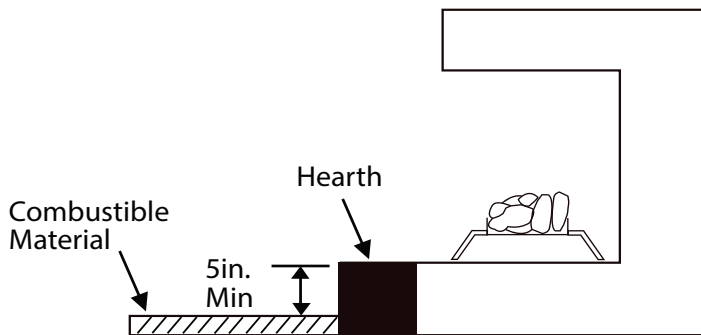

Fig. 7 - Minimum fireplace clearances if installed at floor level

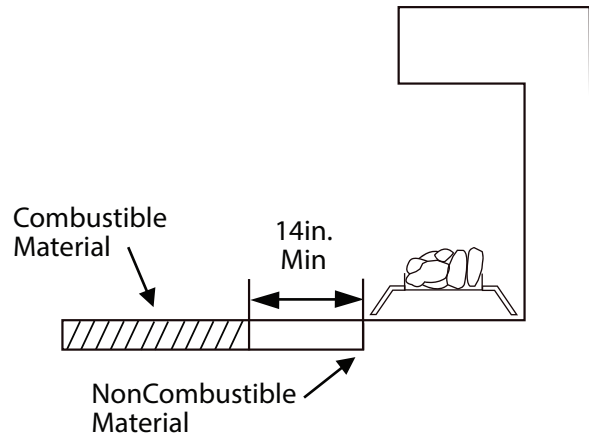
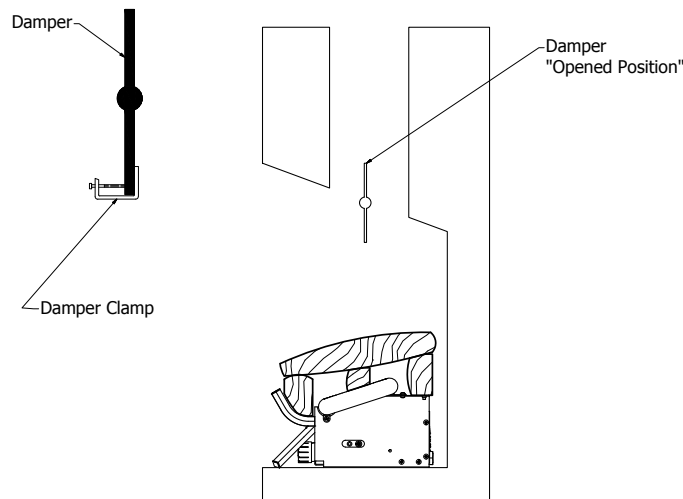

Fig. 9 - Attach Damper to Fireplace



INSTALLING DAMPER CLAMP ACCESSORY FOR VENTED OPERATION

NOTE: When used as a vented heater, appliance must be installed only in a solid-fuel burning fireplace with a working flue constructed of noncombustible material. You may use this heater as a vented product. When used as a vented decorative appliance, use of the thermostat function is prohibited, operate manually only. There are three reasons for operating your heater as a vented model:

1. The fireplace does not meet the clearance requirements for vent-free operation.
2. State or local codes do not permit vent-free operation.
3. You prefer vented operation.

INSTALLATION



WARNING: Failure to position the parts in accordance with these diagrams or failure to use only parts specifically approved with this heater may result in property damage or personal injury.

Before beginning assembly or operation of the product, make sure all parts are present. Compare parts with package contents list. If any part is missing or damaged, do not attempt to assemble, install or operate the product. Contact customer service for replacement parts.

Estimated Assembly Time: 1 to 2 hours

Tools Required for Assembly (Not Included, unless otherwise stated):

Before installing heater, make sure you have the the following:

- Hardware package (provided with heater)
- Approved flexible gas hose if allowed by local codes
- Sealant (resistant to natural or propane/LP gas)
- Electric drill with 3/16- in. drill bit
- Phillips screwdriver
- External regulator (supplied by installer if required)
- Piping (check local codes)
- Equipment shutoff valve
- Test gauge connection
- Sediment trap
- Tee joint
- Pipe wrench
- 3/8" NPT to 3/8" flare fitting

UNPACKING

1. Remove logs, grate, and burner base assembly from carton. NOTE: Do not pick up burner base assembly by burners as this could damage heater. Always handle base assembly by frame.
2. Remove all protective packaging applied to logs and heater for shipment.
3. Check all items for any shipping damage. If damaged, promptly inform dealer where you purchased the heater.

Fig. 10

GRATE ASSEMBLY PROCEDURE

1. Position the grate in front of the burner so the 2 legs are pointing downward, the "grate ends" that the logs sit on are pointing upward, and the screw holes line up with the screw holes on the burner unit (See Fig. 10)
2. Hand tighten the grate to the burner with (2) Attachment Screws, each at an equal distance until hand tightening is no longer possible
3. Finish tightening each Attachment Screw with a screw driver, but make sure not to over tighten.

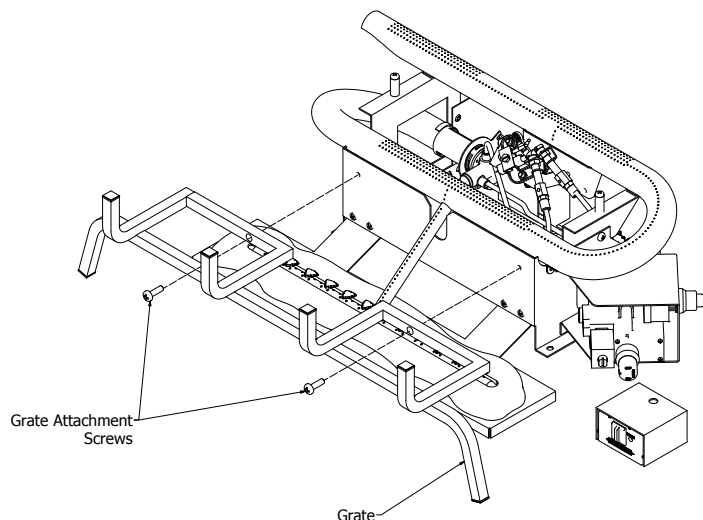

INSTALLATION

GAS SELECTION INSTRUCTIONS

⚠ WARNING: This appliance can be used with propane or natural gas. It is shipped from the factory adjusted for use with propane.

CAUTION: The knob to the gas selection means shall not be accessed or adjusted while the appliance is in operation.

CAUTION: Two gas line installations at the same time are prohibited. The access plate to simple switching means shall not be opened while heater is in operation.

Installation and adjustments shall be made by a qualified technician only.

NOTE: If you are connecting this appliance to propane do not make any adjustments. Proceed to installing the gas line as instructed in the Owner's Manual.

Convert to natural gas:

Step 1 - Remove access panel

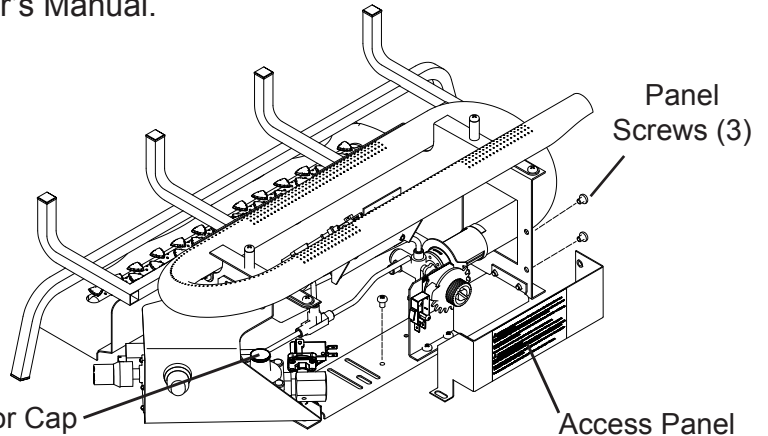

Step 2 - Converting the regulator

Unscrew the cap on top of the pressure regulator by turning it counter clockwise. Unscrew the plunger pin from the regulator cap by turning it counter clockwise. Flip the plunger pin 180 degrees and screw it back into the regulator cap by turning it clockwise. Replace the cap by turning it clockwise back onto the regulator. Make sure the plunger pin and cap are finger tight. (See Fig. 11)

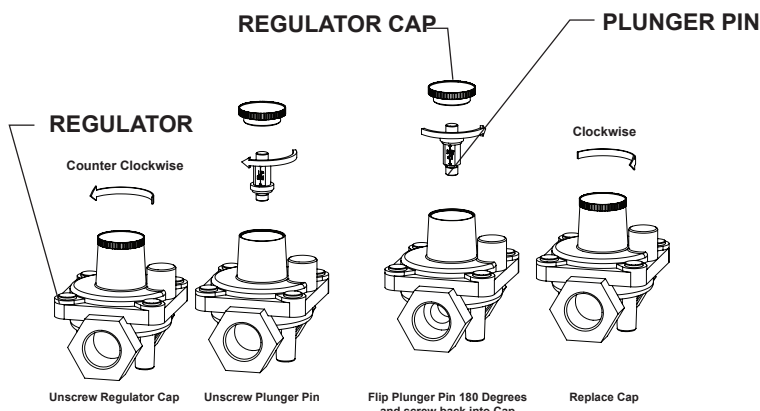

Fig. 11 - Regulator Conversion

Step 3 - Adjust the gas selector valve

Push in on the selector valve Knob and rotate the knob counter clockwise until it stops. Release the knob (See Fig. 12)

Ensure microswitch trips in correct position (see Fig. 12)

Do not operate the appliance between locked positions.

Step 4 - Replace Access Panel

Reverse steps 1 and 2 to convert back to propane gas.

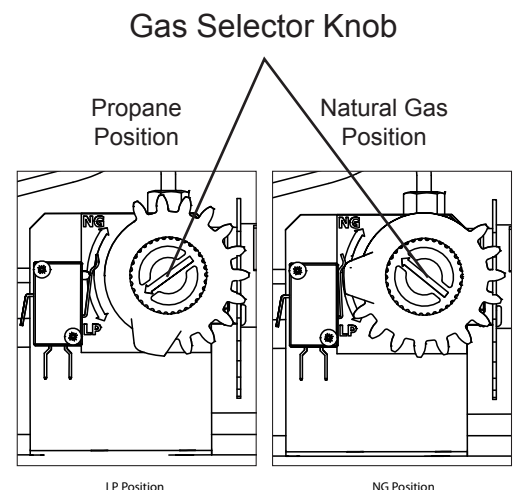

Fig. 12 - Selector Valve

INSTALLATION

CONNECTING TO GAS SUPPLY

⚠ WARNING: A qualified service technician must connect heater to gas supply. Follow all local codes.

CAUTION: Never connect heater directly to the gas supply. This heater requires an external regulator (not supplied). The external regulator between the gas supply and heater must be installed. Gas supplier provides external regulator for natural gas.

⚠ WARNING: Never connect heater to private (non-utility) gas wells. This gas is commonly known as wellhead gas.

The installer must supply an external regulator for liquid propane. The external regulator is provided by the gas supplier for natural gas. The external regulator will reduce incoming gas pressure. You must reduce incoming gas pressure to between 11 and 14 in. of water column for propane and between 6 and 7 in. of water column for natural gas. If you do not reduce incoming gas pressure, heater regulator damage could occur. Install external regulator with the vent pointing down as shown in Fig. 13. Pointing the vent down protects it from freezing rain or sleet.

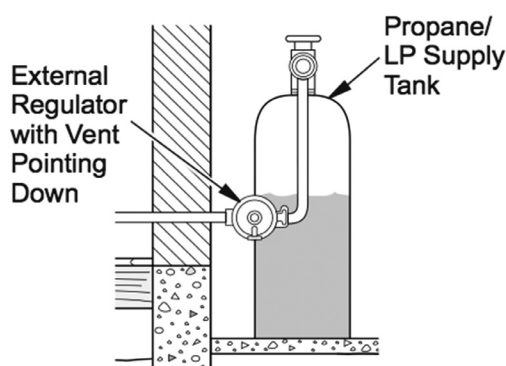

Fig. 13 - Regulator Conversion

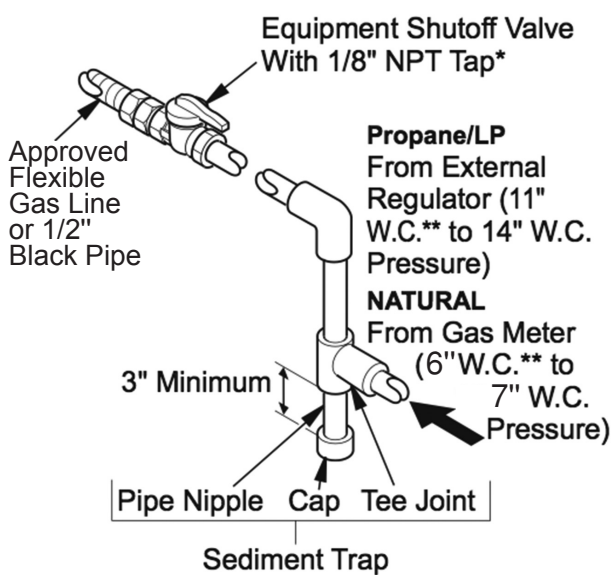

Fig. 14 - Gas Connection

* Purchase the optional equipment shutoff valve from your local Home Center store.

⚠ CAUTION: Use only new black iron or steel pipe. Internally tinned copper tubing may be used in certain areas. Check your local codes. Use pipe of 1/2 in. diameter or greater to allow proper volume gas to heater. If pipe is too small, loss of pressure will occur. Installation must include an equipment shutoff valve, union, and plugged 1/8-in. NPT tap. Locate NPT tap within reach for test gauge hook up. NPT tap must be upstream from heater (See Fig. 14).

IMPORTANT: Install equipment shutoff valve in an accessible location. The equipment shutoff valve is for turning on or shutting off the gas to the appliance. Apply pipe joint sealant lightly to male threads. This will prevent excess sealant from going into pipe. Excess sealant in pipe could result in clogged heater valves.

INSTALLATION

⚠ CAUTION: Use pipe joint sealant that is resistant to gas (PROPANE or NG). We recommend that you install a sediment trap in a supply line. Locate sediment trap where it is within reach for cleaning and not likely to freeze. Install in the piping system between fuel supply and heater. A sediment trap traps moisture and contaminants. This keeps them from going into heater controls. If sediment trap is not installed or is installed incorrectly, heater may not run properly.

⚠ CAUTION: Avoid damage to regulator. Hold gas regulator with wrench when connecting into gas piping and/or fittings. NG Models: 6 in. to 7 in. W.C. Gas supplier provides external regulator for natural gas.

Installation Items Needed (Not Provided)

- 8" Adjustable Wrench
- 8" Pipe Wrench
- 3/8" Flexible Gas Line (24" Min.) or 1/2" Black Pipe
- 90 Deg. 3/8 NPT x 3/8" Flare Fitting or 3/8" Street Elbow
- Sealant (Resistant to Propane (LP) Gas)
- Shut Off Valve

1) A variety of options are possible for routing the Gas Connection Lines depending on where your Gas Supply line is located. Install the 3/8" Fitting to the Heater Regulator using Sealant and direct the attachment and either left or right toward the Gas Supply Line.

NOTICE: Most building codes do not permit concealed gas connections. Check your local building code prior to using a Flexible Gas Line for this installation.

- 2) Install the Gas Line to the 90 Deg. fitting and attach to the Shut Off Valve. It may be necessary to cut and access hole in the side or bottom of the Mantel Cabinet depending on your particular connection.
- 3) Check all connections for gas leaks.

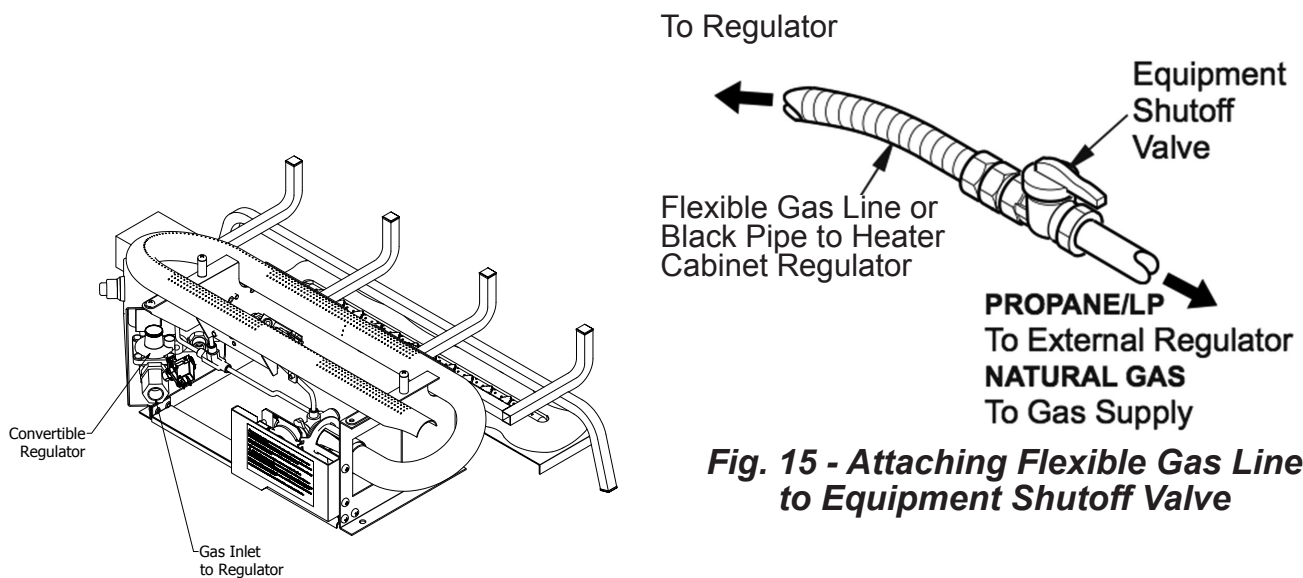

Fig. 15 - Attaching Flexible Gas Line to Equipment Shutoff Valve

INSTALLATION

CHECKING GAS CONNECTIONS

⚠ WARNING: Test all gas piping and connections for leaks after installing or servicing. Correct all leaks immediately.

⚠ WARNING: Never use an open flame to check for a leak. Apply a mixture of liquid soap and water to all joints. If bubbles form, there may be a leak. Correct all leaks immediately.

Pressure Testing Gas Supply Piping System Test Pressures In Excess Of 1/2 PSIG (3.5kPa)

1. Disconnect heater with its appliance main gas valve (control valve) and equipment shutoff valve from gas supply piping system. Pressures in excess of 1/2 PSIG will damage heater regulator.
2. Cap off open end of gas pipe where equipment shutoff valve was connected.
3. Pressurize supply piping system by either using compressed air or opening gas supply tank valve.
4. Check all joints of gas supply piping system. Apply mixture of liquid soap and water to gas joints. If bubbles form, there may be a leak.
5. Correct all leaks immediately.
6. Reconnect heater and equipment shutoff valve to gas supply. Check reconnected fittings for leaks.

Test Pressures Equal To or Less Than 1/2 PSIG (3.5 kPa)

1. Close equipment shutoff valve (See Fig. 16).
2. Pressure supply piping system by either using compressed air or opening gas supply tank valve.
3. Check all joints from gas meter to equipment shutoff valve (See Fig. 17.1 or 17.2). Apply mixture of liquid soap and water to gas joints. If bubbles form, there may be a leak.
4. Correct all leaks immediately.

Pressure Testing Heater Gas Connections

1. Open equipment shutoff valve (See Fig. 16).
2. Open gas supply tank valve.
3. Make sure control knob of heater is in the OFF position.
4. Check all joints from equipment shutoff valve to control valve (See Fig. 17.1 or 17.2). Apply mixture of liquid soap and water to gas joints. If bubbles form, there may be a leak.
5. Light heater (see Operation, page 24).
Check all other internal joints for leaks.
6. Turn off heater (see "To Turn Off Gas to Appliance," page 24).

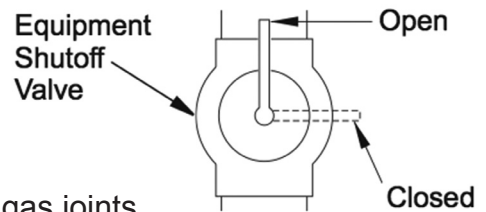
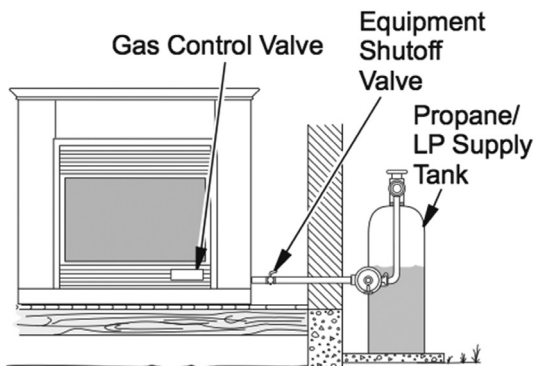
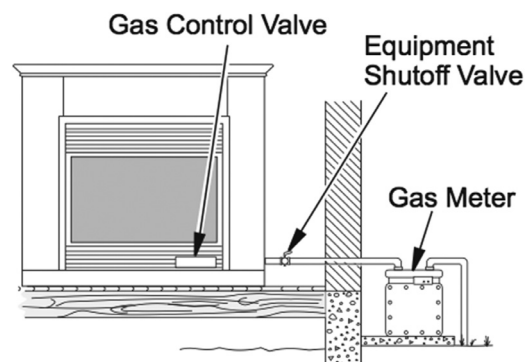

Fig. 16 - Equipment Shutoff Valve



**Fig. 17.1 - Checking Gas Joints
(Propane/LP Only)**



**Fig. 17.2 - Checking Gas Joints
(Natural Gas Only)**

INSTALLATION

In compliance with ANSI Z21.60•CGA2.26 and National Fuel Gas Code, Section 6.

BEFORE INSTALLING THE APPLIANCE

- Turn off gas supply to fireplace or firebox.
- Clean fireplace floor and chimney before installing log set. Seal any ash. Clean out doors to protect the unit from down drafts.

MOUNTING ASSEMBLY PROCEDURE

- Place grate/burner assembly into firebox with the front pan facing forward.
- Drill two (2) 5/32" diameter holes approximately 1" deep.
- Anchor the front pan to the floor using the (2) Concrete Attachment Screws (Not Included). (See Fig. 18).
- Proper installation of the grate is essential to prevent any movement of the gas logs and controls during operation.

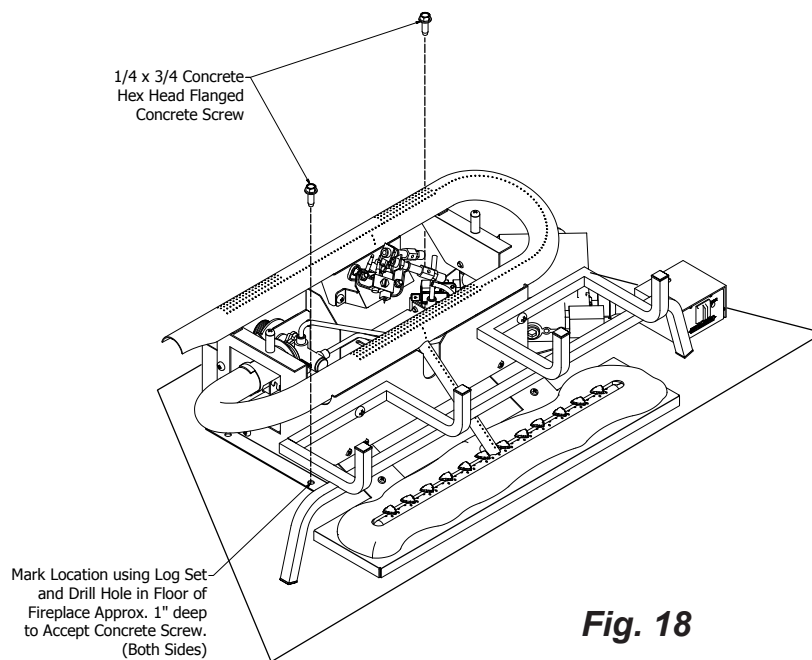

Fig. 18

ASSEMBLING LOGS

⚠ WARNING: Failure to position the parts in accordance with these diagrams or failure to use only parts specifically approved with this heater may result in property damage or personal injury.

⚠ WARNING: All previously applied loose material must be removed prior to reapplication

⚠ CAUTION: After installation and periodically thereafter, check to ensure that no yellow flame comes in contact with any log. With the heater set to High, check to see if yellow flames contact any log. If so, reposition logs according to the log installation instructions in this manual. Yellow flames contacting logs will create soot.

It is very important to install the logs exactly as instructed. Do not modify logs; use only logs supplied with heater. Each log is marked with a number, and this number will help you identify each log during installation.

Provided Logs: 8

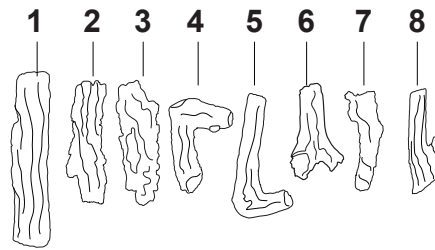
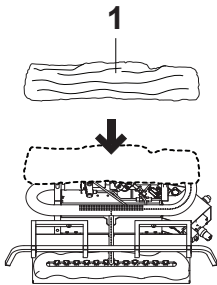
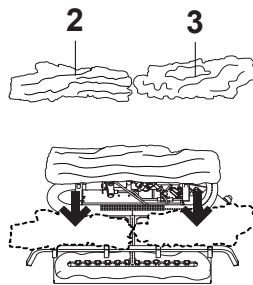

Fig. 19 - Installing Log #1



1. Insert log #1 onto pins in middle grate base.

Fig. 20 - Installing Log #2-3



2. Place log #2 & #3 onto the front grate. Make sure the recessed areas on the log match up with the grate, and the inside end of each log is centered on grate.

Fig. 21 - Installing Log #4

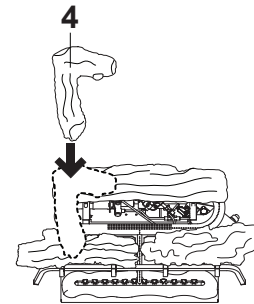

3. Place log #4 so it is resting in the top left recessed areas of logs #1 & #2.

Fig. 22 - Installing Log #5

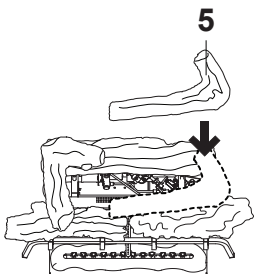

4. Place log #5 so it is resting in the top right recessed areas of logs #1 & #4, and just touching the top right of log #2.

Fig. 23 - Installing Log #6

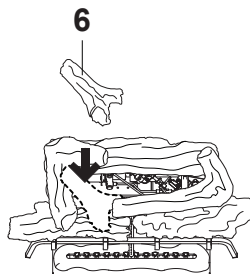

5. Place log #6 so it is resting in the crotch of log #4 and so the crotch of log #6 is in between log #5.

Fig. 24 - Installing Log #7-8

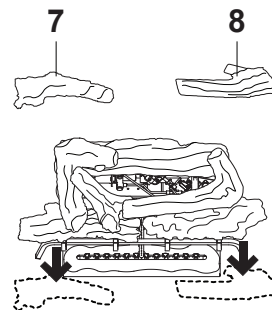

6. Log #7 & #8 are optional - decorative logs that can be placed anywhere NOT on the unit, but on the floor of the firebox. It is recommended to place them as illustrated.

INSTALLATION

EMBER FLAKE INSTALLATION

NOTE: This is an optional accessory, and is not required for operation of the heater.

⚠ WARNING: Apply loose material per instruction manual. **DO NOT** apply extra material or material not supplied with the heater. Replace only with Pleasant Hearth brand Ember Flakes (Model #GEF100).

⚠ WARNING: All previously applied loose material must be removed prior to reapplication.

⚠ WARNING: This appliance includes a material to simulate glowing embers when the unit is in operation. Positioning this material is critical to the safe operation of the unit and directions for the size and placement must be followed explicitly.

1. Open the small bag and remove all of the ember material.
2. Tear the material into flat triangular shapes approximately $\frac{1}{2}$ " on each side.
3. Carefully place the shapes on the horizontal burner tube as depicted in Fig. 25.
4. Make sure the Ember Flakes do not cover the Burner Port Holes.
5. Flames emanating from the Burner Port Holes will cause the ember Flake edges to glow when the unit is in operation.

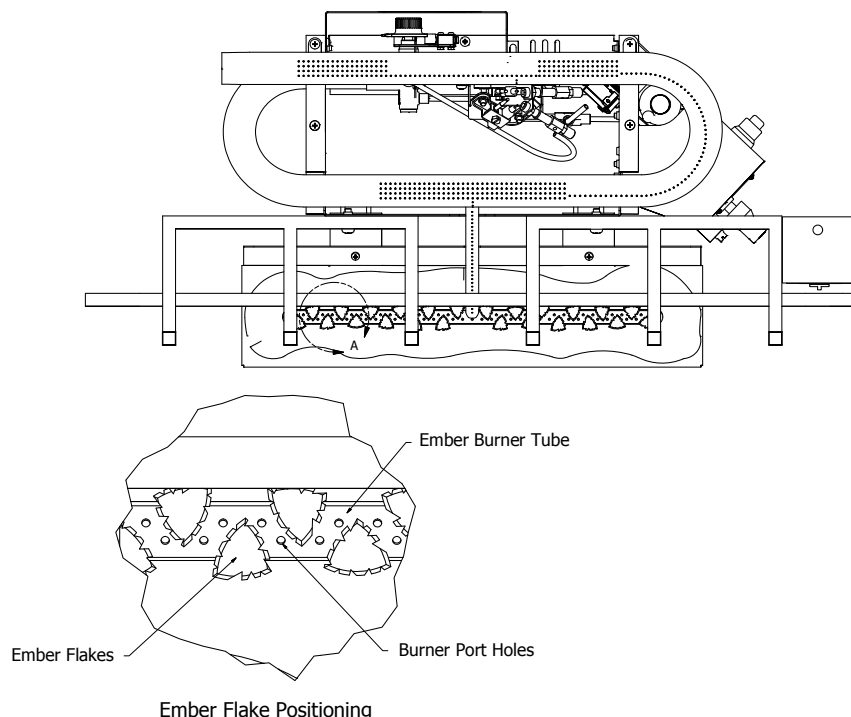

Fig. 25

OPERATION

FOR YOUR SAFETY READ BEFORE LIGHTING



WARNING: If you do not follow these instructions exactly, a fire or explosion may result causing property damage, personal injury or loss of life.

A. This appliance has a pilot which must be lighted by the electronic ignitor. When lighting the pilot, follow these instructions exactly.

B. **BEFORE LIGHTING** smell all around the appliance area for gas. Be sure to smell next to the floor because some gas is heavier than air and will settle on the floor.

WHAT TO DO IF YOU SMELL GAS

- Do not try to light any appliance.
- Do not touch any electrical switch; do not use any phone in your building.
- Immediately call your gas supplier from a neighbor's phone. Follow the gas supplier's instructions.
- If you cannot reach your gas supplier, call the fire department

C. Use only your hand to push in or turn the gas control knob. Never use tools. If the knob will not push in or turn by hand, don't try to repair it, call a qualified service technician. Forced or attempted repair may result in fire or explosion.

D. Do not use this appliance if any part has been under water. Immediately call a qualified service technician to inspect the appliance and to replace any part of the control system and any gas control which has been under water.

BATTERY INSTRUCTIONS

- Batteries are included.
- Remove batteries when depleted.
- Install/replace the batteries according to the type and quantity stated in table below.
- Do not mix old and new batteries. New batteries should be the same brand for best results.
- Be sure to observe proper polarity (+/-) when installing or replacing the batteries. Damage due to improper battery installation may void the warranty on the product.
- For remote control systems, maximize battery life by turning off the receiver when it is not in use.
- For long periods of non-operation, remove batteries from all components for safety.

Component	Type of Battery	Battery Qty.
Ignitor	AAA	1

*Note: Quantity depends on model of remote control.

LIGHTING INSTRUCTIONS

1. STOP! Read the safety information as noted above.
2. Set receiver switch to "ON" position (See Fig. 26).

- When used as a vented decorative appliance, use of the thermostat function is prohibited, operate manually only.

3. Turn control knob clockwise ↷ to the "OFF" position (See Fig. 26).
4. Wait five (5) minutes to clear out any gas. Then smell for gas, including near the floor. If you smell gas, STOP! Follow "B" in the safety information as noted above. If you don't smell gas, go to the next step.
5. Push in slightly and turn control knob counterclockwise ↶ to the "PILOT" position (See Fig. 26). Depress control knob.
6. With control knob depressed, push down on the ignitor button until the pilot lights. The pilot's location is behind log #3 near the center of the burner. (See Fig. 27).
7. Keep control knob depressed for (30) seconds after pilot lights. Release control knob.

- If the control knob does not pop up when released, stop and immediately call a qualified service technician or gas supplier.
- If pilot goes out repeat steps 3 through 7. Wait (1) minute before attempting to light pilot again. If after several tries the pilot still goes out, turn the gas control knob clockwise ↷ to the "OFF" position and call a qualified service technician.

8. Turn control knob counterclockwise ↶ to the "ON" position.
9. To use the included thermostatic remote control, set receiver switch to the "REMOTE" position (See Fig. 28). Press the ON button to turn on the remote to ignite the main burner. Refer to the remote control instruction manual on the next page for "MODE" and "SET" functions.

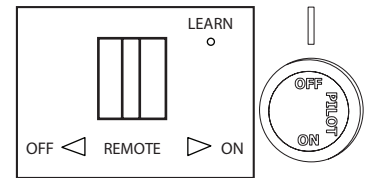
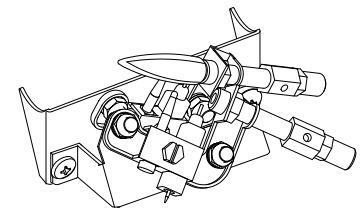

Fig. 26 - Receiver & Control Knob



Note: Small Flame on LP ODS Pilot

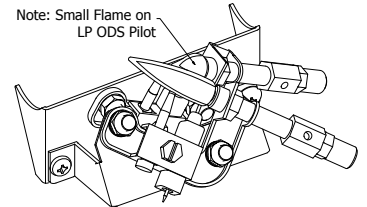

Fig. 27 - Pilot

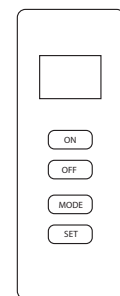

Fig. 28 - Remote

⚠ WARNING: The fireplace screen must be in place while the appliance is in operation.

⚠ WARNING: Any glass doors shall be completely opened while appliance is in operation.

TO TURN OFF GAS TO APPLIANCE

1. Set thermostat to the lowest setting.
2. Press the OFF button on the remote control.
3. Push in slightly and turn control knob clockwise ↷ to the "OFF" position.

REMOTE CONTROL OPERATION

MULTI-FUNCTION WIRELESS REMOTE CONTROL SYSTEM FOR OPERATING A LATCHING SOLENOID VALVE, MANUALLY OR WITH A THERMOSTAT FUNCTION

IF YOU CANNOT READ OR UNDERSTAND THESE INSTALLATION INSTRUCTIONS DO NOT ATTEMPT TO INSTALL OR OPERATE

INTRODUCTION

This remote control system was developed to provide a safe, reliable, and user-friendly remote control system for gas heating appliances. The system is operated manually from the transmitter. The system operates on radio frequencies (RF) within a 20-foot range using non-directional signals. The system operates on one of 1,048,576 security codes that are programmed into the transmitter at the factory; the remote receiver's code must be matched to that of the transmitter prior to initial use.

Review COMMUNICATION SAFETY under GENERAL INFORMATION section. This safety feature shuts down the appliance when a potentially unsafe condition exists.

TRANSMITTER

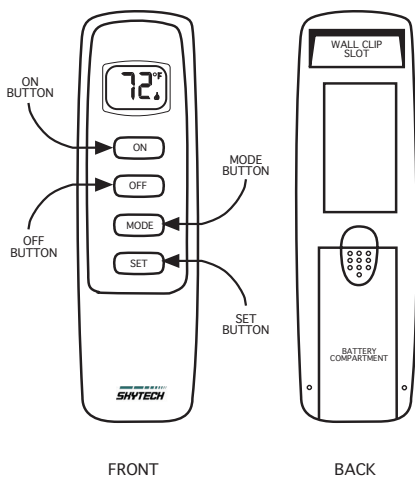

This remote control SYSTEM offers the user a battery-operated remote control to power a latching solenoid such as those used with gas valves used in some heater rated gas logs, gas fireplaces and other gas heating appliances.

The solenoid circuit uses the battery power from the receiver to operate a solenoid. The circuit has reversing polarity software which reverses the positive (+) and negative (-) output of the receiver's battery power to drive a latching solenoid ON/OFF. The SYSTEM is controlled by the remote transmitter.

The transmitter operates on a (2) 1.5V AAA batteries.

It is recommended that ALKALINE batteries always be used for longer battery life and maximum operational performance.

Before using the transmitter, install the (2) AAA transmitter batteries into the battery compartment. (Use caution that batteries are installed in the proper direction)

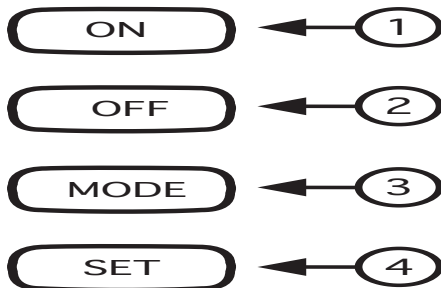

KEY SETTINGS

- ON - Operates unit to on position, Manually operated solenoid ON.
- OFF - Operates unit to off position, Manually operated solenoid OFF.
- MODE - Changes unit from manual mode to thermo mode.
- SET - Sets temperature in thermo mode.

REMOTE CONTROL OPERATION

LCD - Liquid Crystal Display

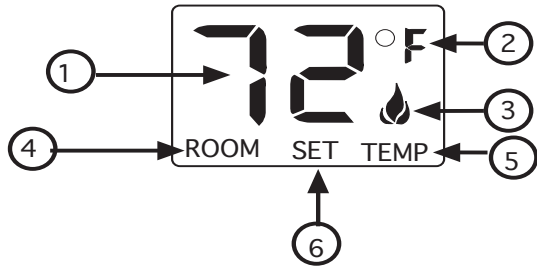

1. **DISPLAY** Indicates CURRENT room temperature .
2. **° F OR ° C** Indicates degrees Fahrenheit or Celsius.
3. **FLAME** Indicates burner/valve in operation.
4. **ROOM** Indicates remote is in THERMO operation.
5. **TEMP** Appears during manual operation.
6. **SET** Appears during time the of setting the desired temperature in the thermo operation.

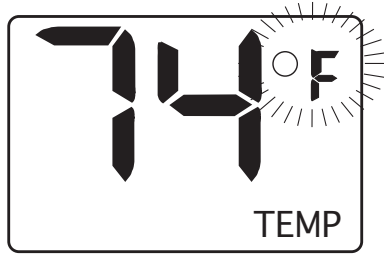

SETTING ° F / ° C SCALE

The factory setting for temperature is **° F**. To change this setting to **° C**, first

- Press the ON key and the OFF key on the transmitter at the same time this will change from **° F** to **° C**. Follow this same procedure to change from **° C** back to **° F**.

MANUAL FUNCTION

To operate the system in the manual "MODE" do the following.

ON OPERATION

Press the ON key the appliance flame will come on. During this time the LCD screen will show **ON**, after 3 seconds the LCD screen will default to display room temperature and the word **TEMP** will show. (**Flame icon wil appear on LCD screen in manual on mode**)

OFF OPERATION

Press the OFF key the appliance flame will shut off. During this time the LCD screen will show **OF**, after 3 seconds the LCD screen will default to display room temperature and the word **TEMP** will show.



SCREEN WHILE DEPRESSING ON KEY

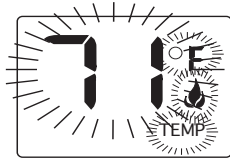

SCREEN AFTER 3 SECOND DEFAULT

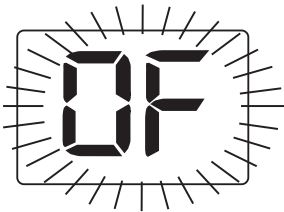

SCREEN WHILE DEPRESSING OFF KEY

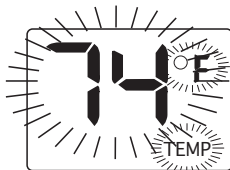

SCREEN AFTER 3 SECOND DEFAULT

THERMOSTAT FUNCTION

SETTING DESIRED ROOM TEMPERATURE

When used as a vented decorative appliance, use of the thermostat function is prohibited, operate manually only.

This remote control system can be thermostatically controlled when the transmitter is in the THERMO mode (The word **ROOM must be displayed on the screen**). To set the THERMO MODE and DESIRED room temperature,

Press the MODE key until the LCD screen shows the word ROOM, then the remote is in the thermostatic mode.

Press and hold the SET key until the desired set temperature is reached. (By pressing and holding the set key the LCD screen set numbers will increase from 45° to 99° then restart over at 45°) Next

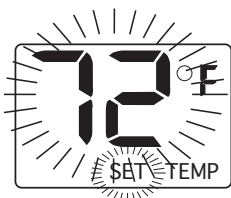

THERMO SET

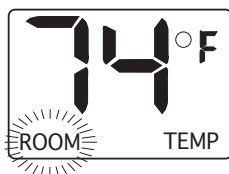

THERMO MODE

REMOTE CONTROL OPERATION

release the **SET** key. The LCD screen will display the set temperature for 3 seconds and the LCD screen will flash the set temperature for 3 seconds, then the LCD screen will default to display the room temperature.

TO CHANGE THE SET TEMPERATURE

Press and hold the **SET** key until the desired set temperature is reached. (By pressing and holding the set key the LCD screen set numbers will increase from 45⁰ to 99⁰ then restart over at 45⁰) Next release the **SET** key. The LCD screen will display the set temperature for 3 seconds, then will flash the set temperature for 3 seconds, then the LCD screen will default to display the room temperature.

Press the **MODE** key to disengage the thermo mode. The word **ROOM** on the LCD screen will not show when the thermo is not in operation.

NOTE: The highest SET temperature is 99⁰ **Fahrenheit** (32⁰ Celsius) and the lowest temperature is 45⁰ **Fahrenheit** (6⁰ Celsius)

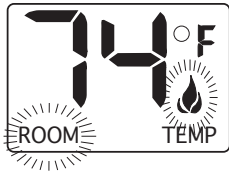

THERMO ON

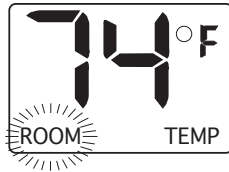

THERMO OFF

OPERATIONAL NOTES:

The Thermo Feature on the transmitter operates the appliance whenever the **ROOM TEMPERATURE** varies a certain number of degrees from the **SET TEMPERATURE**. This variation is called the "SWING" or **TEMPERATURE DIFFERENTIAL**. The normal operating cycle of an appliance may be 2-4 times per hour depending on how well the room or home is insulated from the cold or drafts. The factory setting for the "swing number" is 2. This represents a temperature variation of +/- 2⁰ **F** (1⁰ **C**) between SET temperature and ROOM temperature, which determines when the fireplace will be activated.

The transmitter has ON and OFF manual functions that are activated by pressing either button on the face of the transmitter. When a button on the transmitter is pressed the word ON or OF will appear on the LCD screen to show while the signal is being sent. Upon initial use, there may be a delay of three seconds before the remote receiver will respond to the transmitter. This is part of the system's design.

POWER SETTING – CON 1001 TH

The electronics in the remote control system have the capability of "powering" two different types of DC-powered components. If any operational problems are noted, contact Customer Service.

The **RECEIVER** comes from the factory programmed to provide pulse DC voltage (5.5 VDC to 6.3 VDC) to a latching solenoid.

REMOTE RECEIVER

IMPORTANT

THE REMOTE RECEIVER SHOULD BE POSITIONED WHERE AMBIENT TEMPERATURES DO NOT EXCEED 130° F.

The remote receiver (right) operates on (4) 1.5V AA-size batteries. It is recommended that **ALKALINE** batteries be used for longer battery life and maximum microprocessor performance. **IMPORTANT:** New or fully charged batteries are essential to proper operation of the remote receiver as a latching solenoid power consumption is substantially higher than standard remote control systems.

NOTE: The remote receiver will only respond to the transmitter when the 3-position slide button on the remote receiver is in the **REMOTE** position. The remote receiver houses the microprocessor that responds to commands from the transmitter to control system operation.

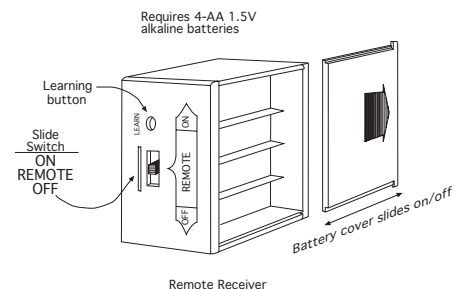

REMOTE CONTROL OPERATION

FUNCTIONS:

- With the slide switch in the REMOTE position, the system will only operate if the remote receiver receives commands from the transmitter.
- Upon initial use or after an extended period of no use, the ON button may have to be pressed for up to three seconds before activating servo motor. If the system does not respond to the transmitter on initial use, see LEARNING TRANSMITTER TO RECEIVER.
- With the slide switch in the ON position you can manually turn ON the system.
- With the slide in the OFF position, the system is OFF.
- It is suggested that the slide switch be placed in the OFF position if you will be away from your home for an extended period of time.
- Placing the slide switch in the OFF position also functions as a safety "lock out" by both turning the system OFF and rendering the transmitter inoperative.

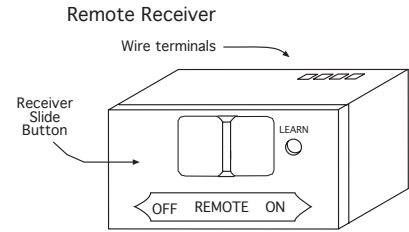

INSTALLATION INSTRUCTIONS

WARNING

DO NOT CONNECT REMOTE RECEIVER DIRECTLY TO 110-120VAC POWER. THIS WILL BURN OUT THE RECEIVER. FOLLOW INSTRUCTIONS FROM MANUFACTURER OF GAS VALVE FOR CORRECT WIRING PROCEDURES. IMPROPER INSTALLATION OF ELECTRIC COMPONENTS CAN CAUSE DAMAGE TO GAS VALVE AND REMOTE RECEIVER.

INSTALLATION

The remote receiver can be mounted on or near the fireplace hearth. PROTECTION FROM EXTREME HEAT IS VERY IMPORTANT. Like any piece of electronic equipment, the remote receiver should be kept away from temperatures exceeding 130° F inside the receiver case. Battery life is also significantly shortened if batteries are exposed to high temperatures.

HEARTH MOUNT

The remote receiver can be placed on the fireplace hearth or under the fireplace, behind the control access panel. Position where the ambient temperature inside the receiver case does not exceed 130° F. **NOTE:** Black Button is used on Hearth Mount Applications.

WIRING INSTRUCTIONS

Make sure the remote receiver switch is in the OFF position. For best results it is recommended that 18 gauge stranded wires should be used to make connections and no longer than 20-feet.

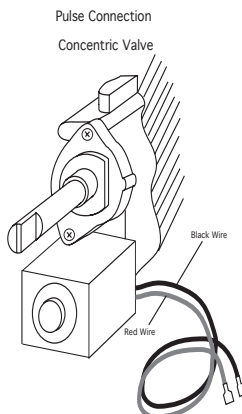

This CON1001 TH remote receiver is to be connected to a manual valve with a latching ON/OFF solenoid.

Connect two 18 gauge stranded or solid wires from the remote receiver terminals to the latching solenoid. (See figure to the right)

IMPORTANT NOTE: Operation of this control is dependent on which wire is attached to which terminal. If operation of control does not correspond to operating buttons on transmitter, reverse wire installation at the receiver or at the control.

NOTE: Up to 6.3 VDC of power is provided at the receiver terminal.

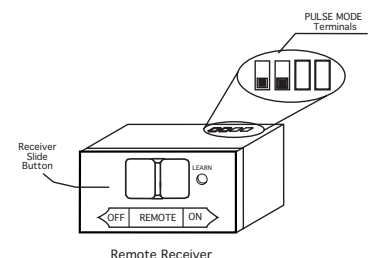
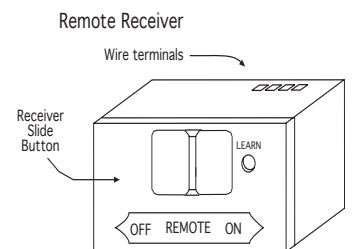

REMOTE CONTROL OPERATION

GENERAL INFORMATION

COMMUNICATION – SAFETY – TRANSMITTER – (C/S – TX)

This remote control has a COMMUNICATION –SAFETY function built into its software. It provides an extra margin of safety when the TRANSMITTER is out of the normal 20-foot operating range of the receiver.

The COMMUNICATION – SAFETY feature operates in the following manner, in all OPERATING MODES – ON/ ON THERMO.

At all times and in all OPERATING MODES, the transmitter sends an RF signal every fifteen (15) minutes, to the receiver, indicating that the transmitter is within the normal operating range of 20-feet. Should the receiver NOT receive a transmitter signal every 15 minutes, the IC software, in the RECEIVER, will begin a 2-HOUR (120-minute) countdown timing function. If during this 2-hour period, the receiver does not receive a signal from the transmitter, the receiver will shut down the appliance being controlled by the receiver. The RECEIVER will then emit a series of rapid “beeps” for a period of 10 seconds. Then after 10 seconds of rapid beeping, the RECEIVER will continue to emit a single “beep” every 4 seconds until a transmitter ON or MODE Button is pressed to reset the receiver. The intermittent 4-second beeping will go on for as long as the receiver’s batteries last which could be in excess of one year.

To “reset” the RECEIVER and operate the appliance, you must press the ON or MODE button on the transmitter. By turning the system to ON, the COMMUNICATION -SAFETY operation is overridden and the system will return to normal operation depending on the MODE selected at the transmitter. The COMMUNICATION – SAFETY feature will reactivate should the transmitter be taken out of the normal operating range or should the transmitter’s batteries fail or be removed.

CP (CHILDPROOF) FEATURE

This remote control includes a CHILDPROOF “LOCK-OUT” feature that allows the user to “LOCK-OUT” operation of the appliance, from the TRANSMITTER.

SETTING “LOCK-OUT” –(CP)

- To activate the “LOCK-OUT” feature, press and hold the ON button and the MODE button at the same time for 5 seconds. The letters CP will appear in the TEMP frame on the LCD screen.
- To disengage the “LOCK-OUT”, press and hold the ON button and the MODE button at the same time for 5 seconds and the letters CP will disappear from the LCD screen and the transmitter will return to its normal operating condition.
- To verify that transmitter is in the CP lock-out mode press any key and the LCD screen will show “CP”

NOTE: If the appliance is already operating in the ON or THERMO MODES, engaging the “LOCK-OUT” will not cancel the operating MODE. Engaging the “LOCK-OUT” prevents only the manual operation of the TRANSMITTER. If in the auto modes, the THERMO operation will continue to operate normally. To totally “LOCK-OUT” the operation of the TRANSMITTER’S operating signals; the transmitter’s MODE must be set to OFF.

LEARNING TRANSMITTER TO RECEIVER

Each transmitter uses a unique security code. It will be necessary to press the LEARN button on the receiver to accept the transmitter security code upon initial use, if batteries are replaced, or if a replacement transmitter is purchased from your dealer or the factory. In order for the receiver to accept the transmitter security code, be sure the slide button on the receiver is in the REMOTE position; the receiver will **not** LEARN if the slide switch is in the ON or OFF position. The LEARN button is located on the front face of the receiver; inside the small hole labeled LEARN. Using a small screwdriver or end of a paperclip gently press and release the black LEARN button inside the hole. When you release the LEARN button the receiver will emit an audible “beep”. After the receiver emits the beep press the transmitter ANY button and release. The receiver will emit several beeps indicating that the transmitter’s code has been accepted into the receiver.

The microprocessor that controls the security code matching procedure is controlled by a timing function. If you are unsuccessful in matching the security code on the first attempt, wait 1 - 2 minutes before trying again--this delay allows the microprocessor to reset its timer circuitry--and try up to two or three more times.

REMOTE CONTROL OPERATION

TRANSMITTER WALL CLIP

The transmitter can be hung on a wall using the clip provided. If the clip is installed on a solid wood wall, drill 1/8" pilot holes and install with the screws provided. If it is installed on a plaster/wallboard wall, first drill two 1/4" holes into the wall. Then use a hammer to tap in the two plastic wall anchors flush with the wall; then install the screws provided.

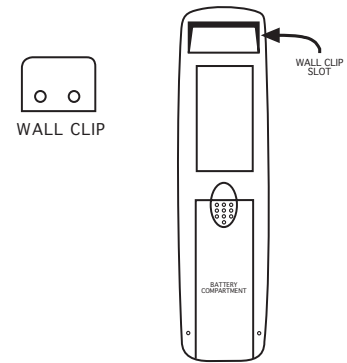

BATTERY LIFE

Life expectancy of the alkaline batteries in the CON1001-TH can be up to 12 months depending on use of the solenoid function. Replace all batteries annually. When the transmitter no longer operates the remote receiver from a distance it did previously (i.e., the transmitter's range has decreased) or the remote receiver does not function at all, the batteries should be checked. It is important that the remote receiver batteries are fully charged, providing combined output voltage of at least 5.5volts. The transmitter should operate with as little as 2.5 volts battery power.

TROUBLE SHOOTING

If you encounter problems with your fireplace system, the problem may be the fireplace itself or it could be with the CON1001-TH remote system. Review the fireplace manufacturer's operation manual to make sure all connections are properly made. Then check the operation of the remote in the following manner:

- Make sure the batteries are correctly installed in the RECEIVER. One reversed battery will keep receiver from operating properly.
- Check battery in TRANSMITTER to ensure contacts are touching (+) and (-) ends of battery. Bend metal contacts in for tighter fit.
- Be sure RECEIVER and TRANSMITTER is within 20 to 25-foot operating range.
- Clear Codes: Memory in the receiver might be full if the learn button is pressed too many times. If this happens it will not allow any more codes to be learned and no audible beep will be heard. To clear memory, place the receiver slide switch into the REMOTE position. Press the learn button and release after 10 seconds. You should hear three (3) long audible beeps indicating all codes have cleared. You can now "learn" the transmitter to the receiver as described in the General Information Section.
- Keep RECEIVER from temperatures exceeding 130° F. Battery life shortened when ambient temperatures are above 115° F.
- If RECEIVER is installed in tightly enclosed metal surround, the operating distance will be shortened.

SPECIFICATIONS

BATTERIES: Transmitter (2) 1.5 volt AAA t bateries
Remote Receiver 6V - 4 ea. AA 1.5 Alkaline

Operating Frequency: 303.8 MHZ

FCC ID No.'s: transmitter - K9LSP1001TH; receiver - K9L330IRX
Canadian IC ID No.'s: transmitter – 2439A-SP1001TH; receiver – 2439A-3301RX

FCC REQUIREMENTS

NOTE: THE MANUFACTURER IS NOT RESPONSIBLE FOR ANY RADIO OR TV INTERFERENCE CAUSED BY UNAUTHORIZED MODIFICATIONS TO THIS EQUIPMENT. SUCH MODIFICATIONS COULD VOID THE USER'S AUTHORITY TO OPERATE THE EQUIPMENT.

OPERATION

INSPECTING BURNERS

Check pilot flame pattern and burner flame patterns often.

PILOT FLAME PATTERN

Figure 29 shows a correct pilot flame pattern. Figure 30 shows an incorrect pilot flame pattern. The incorrect pilot flame is not touching the thermocouple. This will cause the thermocouple to cool. When the thermocouple cools, the heater will shut down.

If pilot flame pattern is incorrect, as shown in Figure 30.

- turn heater off (see To Turn Off Gas to Appliance, page 24).
- see Troubleshooting, page 34.

Note: The pilot flame on natural gas units will have a slight curve, but flame should be blue and have no yellow or orange color.

Fig. 29 - Correct Pilot Flame Pattern

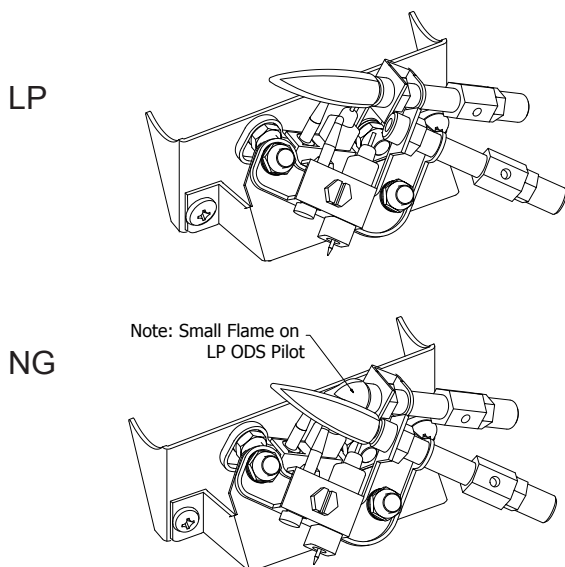
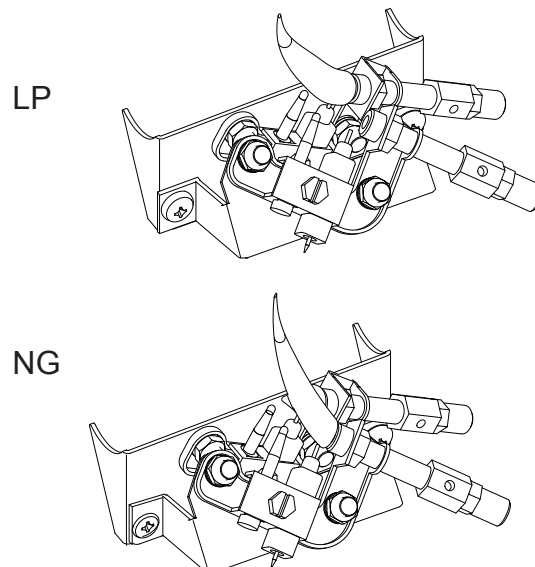

Fig. 30 - Incorrect Pilot Flame Pattern



⚠ WARNING: If yellow tipping occurs, your heater could produce increased levels of carbon monoxide. If burner flame pattern shows yellow tipping, follow instructions at bottom of this page.

⚠ WARNING: Do not allow fans to blow directly into the heater. Avoid any drafts that alter burner flame patterns.

⚠ WARNING: Do not use a blower insert, heat exchanger insert or other accessory not approved for use with this heater.

Notice: Do not mistake orange flames with yellow tipping. Dirt or other fine particles enter the heater and burn causing brief patches of orange flame.

CARE AND MAINTENANCE

BURNER FLAME PATTERN

Figure 31 shows a correct burner flame pattern. Figure 32 shows an incorrect burner flame pattern. The incorrect burner flame pattern shows sporadic, irregular flame tipping. The flame should not be dark or have an orange/reddish tinge.

Note: When using the heater the first time, the flame will be orange for approximately one hour until the log cures.

If burner flame pattern is incorrect, as shown in Figure 32

- turn heater off (see To Turn Off Gas to Appliance, page 24).
- see Troubleshooting, page 34.

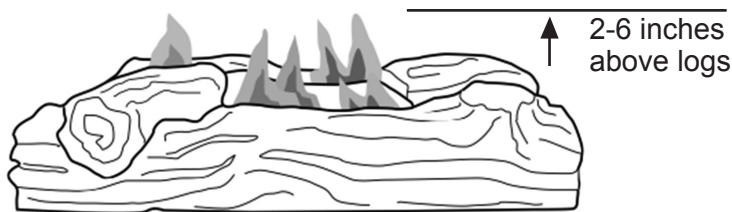

Fig. 31 - Correct/Normal Flame Pattern with short flames

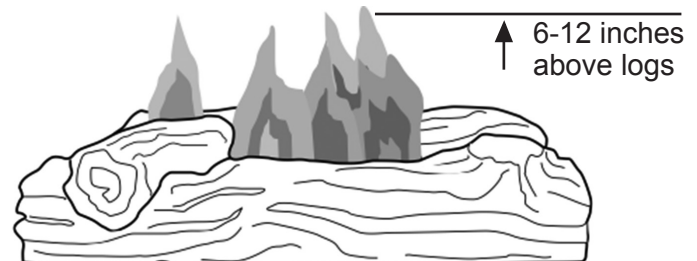

Fig. 32 - Incorrect/Abnormal Flame Pattern with tall flames

⚠ WARNING: Turn off heater and let cool before servicing.

⚠ CAUTION: You must keep control areas, burner, and circulating air passageways of heater clean. Inspect these areas of heater before each use. Have heater inspected yearly by a qualified service person. Heater may need more frequent cleaning due to excessive lint from carpeting, bedding material, pet hair, etc.

⚠ WARNING: Failure to keep the primary air opening(s) of the burner(s) clean may result in sooting and property damage.

BURNER ORIFICE HOLDER AND PILOT AIR INLET HOLE

The primary air inlet holes allow the proper amount of air to mix with the gas. This provides a clean burning flame. Keep these holes clear of dust, dirt, lint and pet hair. Clean these air inlet holes prior to each heating season. Blocked air holes will create soot. We recommend that you clean the unit every three months during operation and have heater inspected yearly by a qualified service person.

We also recommend that you keep the burner tube and pilot assembly clean and free of dust and dirt. To clean these parts we recommend using compressed air no greater than 30 PSI. Your local computer store, hardware store or home center may carry compressed air in a can. If using compressed air in a can, please follow the directions on the can. If you don't follow directions on the can, you could damage the pilot assembly.

FOR VENTED APPLICATIONS

Periodic examination and cleaning of the venting system and the solid fuel-burning fireplace, including frequency of such examination and cleaning, must be done by a qualified agency.

CARE AND MAINTENANCE

1. Shut off unit including pilot. Allow unit to cool for at least 30 minutes.
2. Inspect burner, pilot and primary air inlet holes on orifice holder for dust and dirt (See Fig. 33).
3. Blow air through the ports/slots and holes in the burner.
4. Check the orifice holder located at the end of the burner tube again. Remove any large particles of dust, dirt, lint or pet hair with a soft cloth or vacuum cleaner nozzle.
5. Blow air into the primary air holes on the orifice holder.
6. In case any large clumps of dust have now been pushed into the burner repeat steps 3 and 4. Clean the pilot assembly also. A yellow tip on the pilot flame indicates dust and dirt in the pilot assembly. There is a small pilot air inlet hole about 2" from where the pilot flame comes out of the pilot assembly (see Figures 34 or 35 depending on model). With the unit off, lightly blow air through the air inlet hole. You may blow through a drinking straw if compressed air is not available.

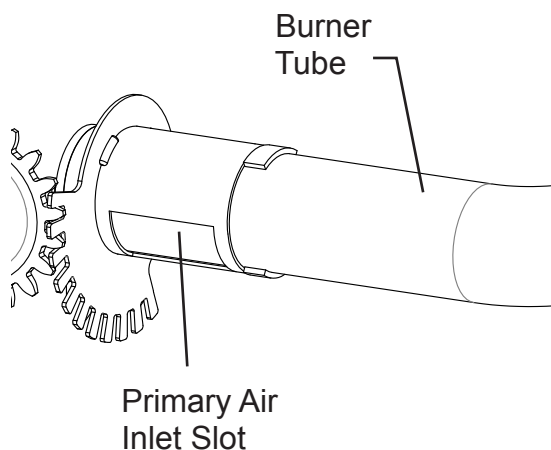

Fig. 33 - Primary Air Inlet Slot on Burner Tube

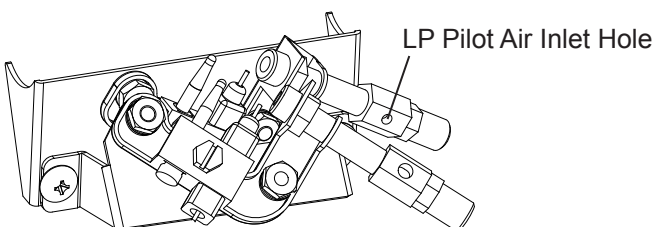

Fig. 34 - Pilot Inlet Air Hole (Propane/LP Gas)

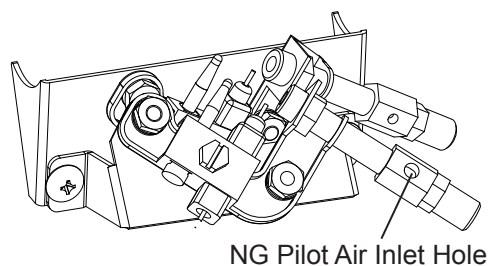

Fig. 35 - Pilot Inlet Air Hole (Natural Gas)

LOG SET

- If you remove the log set for cleaning, refer to page 21, for placement instructions.
- Replace log set if broken or chipped (dime sized or larger).

CABINET

Air Passageways

Use a vacuum cleaner or pressurized air to clean.

Exterior

Use a soft cloth dampened with a mild soap and water mixture. Wipe the cabinet to remove dust.

TROUBLESHOOTING

⚠ WARNING: If you smell gas:

- Shut off gas supply.
- Do not try to light any appliance.
- Do not touch any electrical switch; do not use any phone in your building.
- Immediately call your gas supplier from a neighbor's phone. Follow the gas supplier's instructions.
- If you cannot reach your gas supplier, call the fire department.

IMPORTANT: Operating heater where impurities in air exist may create odors. Cleaning supplies, paint, paint remover, cigarette smoke, cements and glues, new carpet or textiles, etc., create fumes. These fumes may mix with combustion air and create odors.

⚠ WARNING: Make sure that power is turned off before proceeding.

⚠ WARNING: Turn off and let cool before servicing. Only a qualified service person should service and repair heater.

⚠ CAUTION: Never use a wire, needle, or similar object to clean ODS/pilot. This can damage ODS/ pilot unit.

SERVICE HINTS

When Gas Pressure Is Too Low

- pilot will not stay lit
- burners will have delayed ignition
- heater will not produce specified heat
- for propane/LP units, propane/LP gas supply may be low

You may feel your gas pressure is too low. If so, contact your local natural or propane/LP gas supplier.

PROBLEM	POSSIBLE CAUSE	CORRECTIVE ACTION
When ignitor button is pressed in, there is no spark at ODS/ pilot.	<ol style="list-style-type: none"> 1. Ignitor electrode is positioned wrong. 2. Ignitor electrode is broken. 3. Ignitor electrode is not connected to ignitor cable. 4. Ignitor cable is pinched or wet. 5. Damaged ignitor cable. 6. Bad piezo ignitor. 7. Bad Battery. 	<ol style="list-style-type: none"> 1. Replace electrode. 2. Replace electrode. 3. Replace ignitor cable 4. Free ignitor cable if pinched by any metal or tubing. Keep ignitor cable dry. 5. Replace ignitor cable. 6. Replace piezo ignitor. 7. Check Battery and replace if needed.
When ignitor button is pressed in, there is a spark at ODS/ pilot but no ignition.	<ol style="list-style-type: none"> 1. Gas supply is turned off or equipment shutoff valve is closed. 2. Control knob not fully pressed in while pressing ignitor button. 3. Air in gas lines when installed. 4. ODS / pilot is clogged. 5. Gas regulator setting is not correct. 6. Control knob not in PILOT position. 7. Depleted gas supply (propane). 	<ol style="list-style-type: none"> 1. Turn on gas supply or open equipment shutoff valve. 2. Fully press in control knob while pressing ignitor button. 3. Continue holding down control knob. Repeat igniting operation until air is removed. 4. Clean ODS/pilot (see Care and Maintenance, page 32 & 33) or replace ODS/pilot assembly. 5. Replace gas regulator. 6. Turn control knob to PILOT position. 7. Contact local propane/LP gas company.

TROUBLESHOOTING

PROBLEM	POSSIBLE CAUSE	CORRECTIVE ACTION
ODS/pilot lights but flame goes out when control knob is released.	<ol style="list-style-type: none"> 1. Control knob is not fully pressed in. 2. Control knob is not pressed in long enough. 3. Equipment shutoff valve is not fully open. 4. Thermocouple connection is loose. 5. Thermocouple damaged. 6. Control valve damaged. 	<ol style="list-style-type: none"> 1. Press in control knob fully. 2. After ODS/pilot lights, keep control knob pressed in 30 seconds. 3. Fully open equipment shutoff valve. 4. Hand tighten until snug, and then tighten $\frac{1}{4}$ turn more. 5. Replace thermocouple. 6. Contact customer service.
Burner(s) does not light after ODS/pilot is lit.	<ol style="list-style-type: none"> 1. Burner orifice is clogged. 2. Burner orifice diameter is too small. 3. Inlet gas pressure is too low. 	<ol style="list-style-type: none"> 1. Clean burner orifice (see Care and Maintenance, page 32 & 33 or contact customer service. 2. Contact customer service. 3. Contact your gas supplier.
Burner(s) does not light after ODS/pilot is lit. (Heater is set up for NG.)	<ol style="list-style-type: none"> 1. Inlet gas pressure is too high. 	<ol style="list-style-type: none"> 1. Contact your gas supplier.
Delayed ignition of burner(s).	<ol style="list-style-type: none"> 1. Manifold pressure is too low. 2. Burner orifice is clogged. 	<ol style="list-style-type: none"> 1. Contact your gas supplier. 2. Clean burner (see Care and Maintenance, page 32 & 33) or contact customer service.
Burner backfiring during combustion.	<ol style="list-style-type: none"> 1. Burner orifice is clogged or damaged. 2. Burner is damaged. 3. Gas regulator is damaged. 	<ol style="list-style-type: none"> 1. Clean burner orifice (see Care and Maintenance, page 32 & 33 or contact customer service. 2. Contact dealer or customer service. 3. Replace gas regulator.
High yellow flame during burner combustion	<ol style="list-style-type: none"> 1. Not enough air. 2. Gas regulator is defective. 3. Inlet gas pressure is too low. 	<ol style="list-style-type: none"> 1. Check burner for dirt and debris. If found, clean burner (see Care and Maintenance, page 32 & 33). 2. Replace gas regulator. 3. Contact your gas supplier.
Gas odor during combustion.	<ol style="list-style-type: none"> 1. Foreign matter between control valve and burner. 2. Gas leak. (See Warning Statement at top of page 34). 	<ol style="list-style-type: none"> 1. Take apart gas tubing and remove foreign matter. 2. Locate and correct all leaks (see "Checking Gas Connections," page 19).
Heater produces a clicking/ticking noise just after burner is lit or shut off.	<ol style="list-style-type: none"> 1. Metal is expanding while heating or contracting while cooling. 	<ol style="list-style-type: none"> 1. This is common with most heaters. If noise is excessive, contact qualified service technician.

TROUBLESHOOTING

PROBLEM	POSSIBLE CAUSE	CORRECTIVE ACTION
White powder residue forming within burner box or on adjacent walls or furniture.	1. When heated, the vapors from furniture polish, wax, carpet cleaners, etc., turn into white powder residue.	1. Turn heater off when using furniture polish, wax, carpet cleaner or similar products.
Heater produces unwanted odors.	1. Heater is burning vapors from paint, hair spray, glues, etc. See IMPORTANT statement, page 34. 2. Gas leak. See Warning Statement, page 34. 3. Low fuel supply.	1. Ventilate room. Stop using odor causing products while heater is running. 2. Locate and correct all leaks (see "Checking Gas Connections," page 19). 3. Refill supply tank (Propane /LP models).
Heater shuts off in use (ODS operates).	1. Not enough fresh air is available. 2. Low line pressure. 3. ODS/pilot is partially clogged.	1. Open window and/or door for ventilation. 2. Contact local gas supplier. 3. Clean ODS/pilot (see Care and Maintenance, page 32 & 33).
Gas odor exists even when control knob is in OFF position.	1. Gas leak. See Warning Statement at top of page 34. 2. Control valve is defective.	1. Locate and correct all leaks (see "Checking Gas Connections", page 19). 2. Contact customer service.
Moisture/condensation noticed on windows.	1. Not enough combustion/ventilation air.	1. Refer to "Air for Combustion and Ventilation" requirements, page 8.
Slight smoke or odor during initial operation	1. Residues from manufacturing process.	1. Problem will stop after a few hours of operation.
Heater produces a whistling noise when burner is lit.	1. Turning control knob to high (5) position when burner is cold. 2. Air in gas line. 3. Air passageways on heater are blocked. 4. Dirty or partially clogged burner orifice.	1. Turn control knob to low (1) position and let warm up for a minute. 2. Operate burner until air is removed from line. Have gas line checked by local propane/LP gas company. 3. Observe minimum installation clearances (Fig. 5, 6, 7, 8, 9, page 13-14). 4. Clean burner (see Care and Maintenance, page 32 & 33) or contact customer service.

REPLACEMENT PARTS LIST

For replacement parts, call our Technical Service Department at 1-877-447-4768, 8:30 a.m. – 4:30 p.m., CST, Monday – Friday.

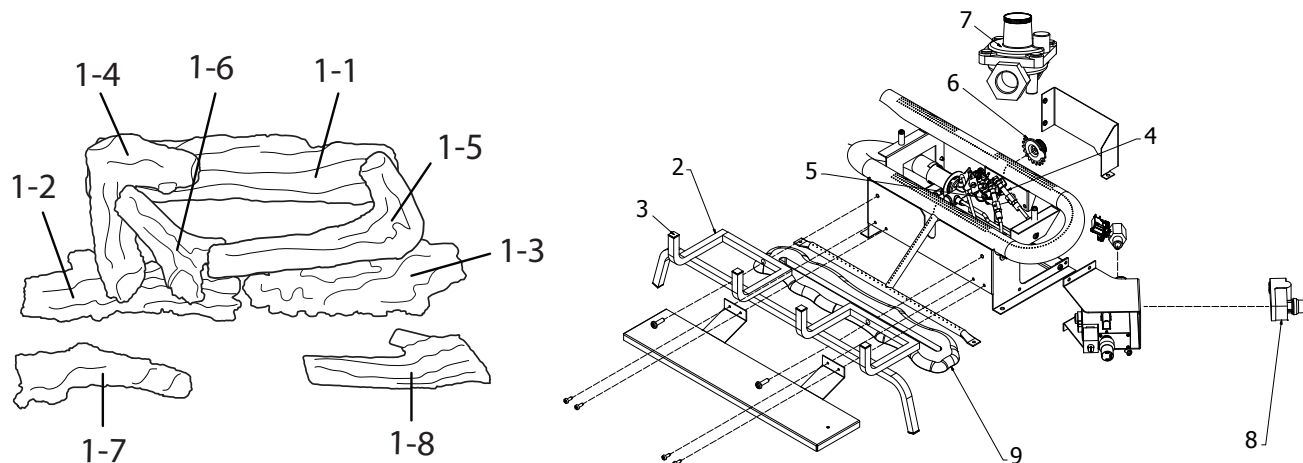

ITEM NO.	DESCRIPTION	QTY	PART NO.	
			VFL-CY24DR VFL-HT24DR	VFL-CY30DR VFL-HT30DR
1	Log Set (complete)	1	80-06-045	80-06-046
1 - 1	Log 1	1	4UB2A	4UB3A
1 - 2	Log 2	1	H-010A	H-003A
1 - 3	Log 3	1	H-010B	H-003B
1 - 4	Log 4	1	H-0075	H-0075
1 - 5	Log 5	1	H-0139	H-0139
1 - 6	Log 6	1	H-0812	H-0812
1 - 7	Log 7	1	H-0370	H-0370
1 - 8	Log 8	1	H-0356	H-0356
2	Grate	1	800-EB2410	800-EB3010
3	Grate End Cap	1	EXP-4509	EXP-4509
4	ODS Pilot	1	EXP-4046-246	EXP-4046-246
5	ODS Pilot - NG	1	EXP-4046-247	EXP-4046-247
6	Selector Knob	1	EXP-4022B	EXP-4022B
7	Regulator	1	EXP-7010	EXP-7010
8	Ignitor Module	1	EXP-4044	EXP-4044
9	Ember Bed	1	EXP-4519	EXP-4519
10	Remote Receiver	1	80-05-102*	80-05-102*
11	Thermostat Remote	1	80-05-101*	80-05-101*

*Item/version not shown in exploded parts diagram

ACCESSORIES

NOTICE: All accessories may not be available for all models.

Glowing Ember Fibers - GEF100 For all models. Material to simulate glowing embers when the unit is in operation. Creates a realistic glowing effect just like a real fire.

Warranty

LIMITED WARRANTY:

This limited warranty is extended to the original retail purchaser of this heater and warrants against any defect in materials and workmanship for a period of two (2) years from the date of retail sale. GHP Group, Inc., at its option, will either provide replacement parts or replace or repair the unit, when properly returned to the retailer where purchased or one of our service centers as directed by GHP Group, Inc., within two (2) years of retail purchase. (Shipping costs, labor costs, etc. are the responsibility of the purchaser.)

DUTIES OF THE OWNER:

This heating appliance must be operated in accordance with the written instructions furnished with this heater. This warranty shall not excuse the owner from properly maintaining this heater in accordance with the written instructions furnished with this heater. A bill of sale, canceled check or payment record must be kept to verify purchase date and establish warranty period. Original carton should be kept in case of warranty return of unit.

WHAT IS NOT COVERED:

1. Damage resulting from use of improper fuel.
2. Damage caused by misuse or use contrary to the owners manual and safety guidelines.
3. Damage caused by a lack of normal maintenance.
4. Use of non-standard parts or accessories.
5. Damage caused in transit. Freight charges on warranty parts or heaters to and from the factory shall be the responsibility of the owner.

This warranty does not imply or assume any responsibility for consequential damages that may result from the use, misuse, or the lack of routine maintenance of this heating appliance. A cleaning fee and the cost of parts may be charged for appliance failures resulting from lack of maintenance. This warranty does not cover claims which do not involve defective workmanship or materials. **FAILURE TO PERFORM GENERAL MAINTENANCE (INCLUDING CLEANING) WILL VOID THIS WARRANTY.**

THIS LIMITED WARRANTY IS GIVEN TO THE PURCHASER IN LIEU OF ALL OTHER WARRANTIES, EXPRESSED OR IMPLIED, INCLUDING BUT NOT LIMITED TO THE WARRANTIES OF MERCHANTABILITY OF FITNESS FOR A PARTICULAR PURPOSE. THE REMEDY PROVIDED IN THIS WARRANTY IS EXCLUSIVE AND IS GRANTED IN LIEU OF ALL OTHER REMEDIES. IN NO EVENT WILL GHP GROUP, INC. BE LIABLE FOR INCIDENTAL OR CONSEQUENTIAL DAMAGES.

Some states do not allow limitations on how long an implied warranty lasts, so the above limitation may not apply to you. Some states do not allow the exclusion or limitation of incidental or consequential damages so the above limitation or exclusion may not apply to you.

CLAIMS HANDLED AS FOLLOWS:

1. Contact your retailer and explain the problem.
2. If the retailer is unable to resolve the problem, contact our Customer Service Dept. detailing the heater model, the problem, and proof of date of purchase.
3. A representative will contact you. DO NOT RETURN THE HEATER TO GHP GROUP, INC. unless instructed by our Representative. This warranty gives you specific legal rights and you may also have other rights which vary from state to state.

TO REGISTER THE WARRANTY ON YOUR HEATER, PLEASE FILL OUT THIS CARD COMPLETELY
AND MAIL WITHIN 14 DAYS FROM DATE OF PURCHASE OR REGISTER ON-LINE AT www.ghpgroupinc.com

NAME: _____ PHONE: () _____ EMAIL: _____
ADDRESS: _____ CITY: _____ STATE: _____ ZIP: _____
MODEL: _____ SERIAL #: _____ DATE PURCHASED: _____
DEALER PURCHASED FROM: _____ TYPE OF STORE: _____
CITY & STATE WHERE PURCHASED: _____ PRICE PAID: _____

Please Take a Minute To Give Us Your Answers To The Following Questions.

All Responses Are Used Solely For Market Research And Are Held In Strict Confidence.

Who primarily decided this purchase? Male Female 18-24 25-39 40-59 60 and over

Purpose of Purchase? _____

Do you own any other portable heaters? Yes No If yes, type _____ brand _____

How do you intend to use your new heater? Construction Site Farm Warehouse/Commercial Garage/Outbuilding Other

How did you become aware of this heater? In-Store Display Newspaper Ad Magazine Ad Friend/Relative

TV Commercial Store Salesperson Other _____

What made you select this heater? Style Size/Portability Price Package Brand Other _____

Do you: own rent Would you recommend this heater to a friend? Yes No

Please give us your comments: _____

THANK YOU FOR COMPLETING THIS FORM!

Information will be held confidential.

WARRANTY REGISTRATION

IMPORTANT: We urge you to fill out your warranty registration card within fourteen (14) days of date of purchase. You can also register your warranty on the internet at www.ghpgroupinc.com. Complete the entire serial number. Retain this portion of the card for your records.



GHP Group, Inc.
6440 W Howard St
Niles, IL 60714-3302

Tel: (877) 447-4768
www.ghpgroupinc.com

SAVE THIS CARD!

Place
Postage
Stamp
Here

GHP Group, Inc.
6440 W Howard St
Niles, IL 60714-3302