

OPERATION  
SAFETY  
SERVICE  
WARRANTY  
CONTACT  
SPECIFICATIONS  
TROUBLESHOOTING

# Grizzly GP-33

Instruction Manual



# THANK YOU FOR PURCHASING A B-AIR PRODUCT.

## Introduction to Grizzly GP-33

Your new Grizzly B-Air #GP-33 dryer / air mover has a 1/3 hp high efficiency motor with the following features:

- State of the art construction
- Stackable
- 25 foot cord
- Low amps (l 2.8a/ m2.85a / h3.65a)
- 2700 cfm
- "daisy chain capability" up to 3 units
- Built in gfci breaker
- Safety screens on open vents
- Easy grip carrying handle
- Swing out kick- stand.
- Safety locks to lock adapter ( #ddk)
- Safety green
- 3 speed switch

## Operation/Use

3 SPEED MAIN SWITCH

GFCI PLUG

CARRYING HANDLE

AIR INTAKE

AIR OUTLET

POWER CORD PLUG

KICK STAND



This high air volume dryer / air mover is intended to dry floors, carpets, walls, etc. And circulate air.

- A) Carefully place the Grizzly B-Air unit on a stable flat dry surface during operation.
- B) Use free standing or with attachments  
The Grizzly B-Air unit can be positioned to aim airflow across flat surfaces or angled upward. Raise or lower the attached kick stand for height adjustment.
- C) Turn on the switch to desired speed and make sure it is operating correctly.
- D) All dryers / air movers in operation must be supervised at all times.

## Storage

Store unit indoors in a clean dry environment to ensure long life

## Safety

- 1) Keep children and pets away from unit while in operation and/or plugged in.
- 2) Do not put fingers or other objects in unit while in operation and/or plugged in.
- 3) To avoid electric shock do not operate in pooled water.
- 4) Unit must be kept dry at all times, including motor, wiring and exterior. If unit becomes wet, thoroughly dry before next operation.
- 5) Indoor use: use only with a grounded plug and/or extension cord to avoid risk of electrical shock or fire. Remember never to use a cord with any kind of damage or wear.
- 6) Make sure the power source is sufficient to meet the requirements of the dryer / air mover.
- 7) To prevent overheating the unit, keep air intakes clear at all times.
- 8) Clogging or blocking the air intakes could result in a fire or electrical hazard.
- 9) In order to prevent injury do not remove any screens or safety guards from the unit and to avoid objects from coming in contact with the dryer's wheel. Unit damage in this manner will void your warranty.
- 10) Do not operate unit close to any dangerous areas, such as explosive gases, flammables, heaters and unventilated environments, which may result in explosions or electrical hazards.
- 11) Do not use any form of speed control device as doing so may cause injury or fire.
- 12) Always place dryer / air mover on a smooth and leveled surface for safe operation.
- 13) Do not use unit if damaged.
- 14) Before cleaning or servicing unplug unit.
- 15) All dryers / air movers in operation must be supervised at all times.
- 16) Do not expose to rain, water or snow.
- 17) Unit must be connected to a GFCI (ground fault circuit interrupter) protected receptacle.

## Warning!

All dryers / air movers in operation must be supervised and attended at all times. The use of a 3-prong to 2-prong adapter is prohibited. Only use a 2-prong to 2-prong adapter.

If the power supply cord is damaged, it must be replaced by the manufacturer, its service agent or similarly qualified persons in order to avoid a hazard.

## Limited Warranty

**Proof of purchase is required on all warranty claims.**

### 1 Year Warranty:

B-air will cover all parts (except power cord) within one year of purchase b-air will pay repair costs and one way ups ground service shipping to your location within the 48 contiguous states. Proof of purchase is required.

Customer is responsible for shipment of damaged unit to b-air warehouse for repair. Canada and non-contiguous states must pay freight both ways.

## **5 Year Warranty:**

B-air will cover housing from date of original purchase. Proof of purchase is required.

## **Grizzly B-Air Limited Warranty**

### **Covers**

- 1) Grizzly B-Air dryers / air movers are covered against defects in material and craftsmanship used under normal intended use to original purchaser for a term of (1) one-year from the original date of purchase including parts, labor and shipping.
- 2) Grizzly b-air dryer / air mover's housing is covered for a term of (5) five full years from the date of the original purchase.

### **Does not cover**

Any signs of misuse including, but not limited to rough handling, abuse, tampering, improper voltage use, and unauthorized maintenance and repairs.

## **Service**

In order to receive service or replacement parts under warranty, you must:

- 1) Call for a RMA# (return merchandise authorization number)
- 2) Have proof of purchase
- 3) Ship to B-Air blower
  - If immediate service is required, b-air will ship a refurbished dryer / air mover immediately to replace the one requiring service provided a valid credit card is provided and charged. once we receive your dryer / air mover, we will credit your credit card account.
  - We will gladly repair your dryer / air mover and ship within 24 hours.

Upon inspection, we will advise you of the repairs needed and the cost (if applicable).



























B-Air will issue repair or replacement parts depending on warranty.

## **Cords**

- 1) Do not use extension cords for outside use.
- 2) Use 3 prong adaptors that are UL and CE approved and not less than 14-3 with ground fault circuit interrupter (GFCI).
- 3) Do not use cords that show any kind of wear or damage.
- 4) Cords are not covered by warranty.

# Grizzly GP-33

## PART LIST

A. Housing -----		----- X1
B. Motor -----		----- X1
C. Fan -----		----- X1
D. Air Exhaust Grill -----		----- X1
E. Air Intake Grill (M) -----		----- X1
F. Air Intake Grill (F) -----		----- X1
G. Power Cord -----		----- X1
H. GFCI -----		----- X1
I. GFCI Cover -----		----- X1
J. Air Guide Blade -----		----- X1
K. Capacitor -----		----- X1
L. Fastener Clip -----		----- X2
M. Switch -----		----- X1
N. Switch Knob -----		----- X1
O. Switch Cover -----		----- X1
P. Rivet 4x16mm -----		----- X13
Q. Rivet 5x19mm -----		----- X14
R. Screw 3x10mm -----		----- X4
S. Screw 4x16mm -----		----- X10
T. Screw 4x12mm -----		----- X4
U. Screw 6x16mm -----		----- X4
V. Rack Feet -----		----- X2
W. Rack Tube -----		----- X2
X. Cord Connector -----		----- X1
Y. Kick Stand -----		----- X1
Z1. Rubber Feet -----		----- X2
Z2. Rubber Feet -----		----- X4

## Explosion of Grizzly GP-33

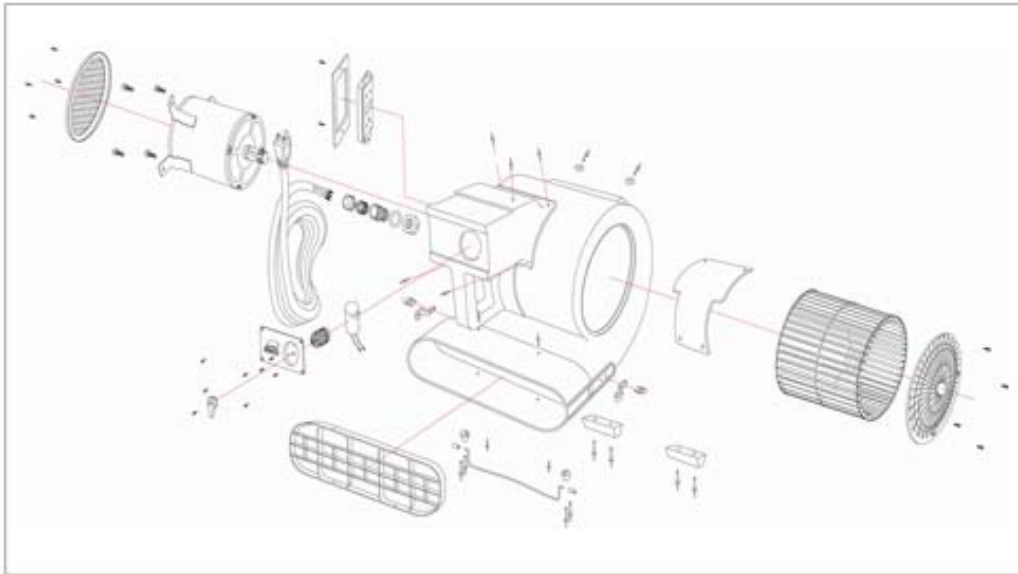

## Troubleshooting

PROBLEM	POSSIBLE CAUSE	SOLUTION
Motor Not Running	a) Switch is OFF b) Bad Outlet c) Faulty Switch/Cord	a) Turn Switch ON b) Check Outlet/ Change to Another Outlet c) Call Factory for new Switch/Replace Cord
Scraping Noise From Blower	a) Wheel Out Of Line	a) Call Factory for Replacement Advise
Weak Air Flow	a) Obstructed Vents/Inlets	a) Clean Out Vents/Inlets

## Specifications

VOLTS	115 V	230 V
CYCLE	60 Hz	50 Hz
MAX AIR VOLUME	2700 CFM	2500 CFM
AMPS	1.2.8/ M2.85 / H13.65	1.1.65 / M1.85 / H12.3
MAX STATIC PRESSURE	1.4"	1.2"
WEIGHT NET/SHIP	28/32 LBS	28/32 LBS
UNIT SIZE (L x W x H)	19" x 18" x 17.5"	19" x 18" x 17.5"
WHEEL SPEED (RPM)	1.990 / M1070 / H1140	1.880 / M910 / H960
MOTOR	1/3 HP	1/3 HP
ATTACHED CORD (14G)	25 FT /14G	25 FT / 14G
SPEEDS	3	3
KICK STAND HEIGHT	4.5"	4.5"

Please note GFCI is not available in 230V

# WARRANTY REGISTRATION

Please complete and mail or fax for your product warranty, for a multiple units, please list serial numbers on a separate sheet

THIS WARRANTY CARD AND YOUR BILL OF SALE MUST BE PRESENTED FOR WARRANTY SERVICE.

Your Company Name	_____
Contact Name	_____ Title _____
Address	_____
City	_____ State _____ Zip _____
Phone	_____ Fax _____
E-mail	_____
<b>GRIZZLY GP-33</b>	
Serial Number	_____ Date of Purchase ____ / ____ / ____
Purchased From	_____
Additional Comments/Suggestions	_____
	_____
	_____



Intertex, Inc. / B-Air Blowers

1851 Tyburn Street, Glendale, CA 91204

1-877-800-2247 (BAIR)

Fax: (818) 242-2430

Email: [info@b-air.com](mailto:info@b-air.com)

Web site: [www.b-air.com](http://www.b-air.com)

---

---

---

PLACE  
STAMP  
HERE



Intertex, Inc. / B-Air Blowers  
1851 Tyburn Street, Glendale, CA 91204