



1.4mm HVLP Gravity Feed Spray Gun

Instruction Manual

19000



Need help?

Call our customer service hotline at 1-800-386-0191

For up-to-date product information, accessories and for a Spanish version of this manual, please visit our website at: www.titan-us.com and click on the literature link or scan the QR Code at left with your smart phone.

SAVE THESE INSTRUCTIONS

INTRODUCTION

It is the owner and/or operators responsibility to study all WARNINGS, operating, and maintenance instructions contained on the product label and instruction manual prior to operation of this product. The owner/operator shall retain product instructions for future reference.

The owner and/or operator are responsible for maintenance, maintaining all decals or warning labels and while in use, maintaining the unit in good working order. If the owner and/or operator are not fluent in English, the product warnings and instructions shall be read and discussed with the operator's native language by the purchaser/owner or his designee. Make sure that the operator comprehends its contents. Safety information shall be emphasized and understood prior to usage. The product shall be inspected per the operating instructions.

Users of this product must fully understand these instructions. Each person operating the product must also be of sound mind and body and must not be under the influence of any substance that might impair their vision, dexterity, or judgment.

Protect yourself and others by observing all safety information.

Failure to comply with instructions could result in personal injury and/or property damage!

If you encounter any problems or difficulties, please contact our customer service department at:

1-800-386-0191

This instruction manual is intended for your benefit. Please read and follow the safety, installation, maintenance and troubleshooting steps described within to ensure your safety and satisfaction. The contents of this instruction manual are based upon the latest product information available at the time of publication. The manufacturer reserves the right to make product changes at any time without notice.

SAFETY ALERT

⚠ WARNING Read and understand this entire instruction manual before attempting to assemble, install, operate or maintain the product. Failure to comply with the instructions may result in serious personal injury and/or property damage!

The following signal words are used to emphasize safety warnings that must be followed when using this product:

⚠ DANGER Indicates an imminently hazardous situation that, if not avoided, WILL result in death or serious injury.

⚠ WARNING Indicates a potentially hazardous situation that, if not avoided, COULD result in death or serious injury.

⚠ CAUTION Indicates a potentially hazardous situation that, if not avoided, MAY result in minor or moderate injury.

⚠ NOTICE Indicates important information, which if not followed, may cause damage to equipment.

UNPACKING & INSPECTION

After opening the carton, unpack your new product and related parts and accessories. Please inspect it carefully for any damage that may have occurred during transit. Please check it against the photograph on carton. If any parts are missing, please call factory customer service at 1-800-386-0191.

⚠ WARNING Do not operate this product if damaged during shipment, handling or misuse. Do not operate the product until the parts have been replaced or the fault rectified. Failure to do so may result in serious personal injury or property damage.

All damaged parts must be repaired or replaced as needed prior to operating this product.

Check to see that all nuts, bolts and fittings are secure before putting this tool into service. If you have any questions, or require assistance with damaged or missing parts, please contact our factory customer service department at:
1-800-386-0191

Please have the model number, and date of purchase available for reference when calling.

MODEL NUMBER: 19000

DATE of PURCHASE: _____



IMPORTANT SAFETY RULES FOR ALL SPRAY GUNS

SAVE THESE INSTRUCTIONS

⚠ WARNING Read and understand all instructions. Failure to follow all instructions included with this product could result in serious personal injury and/or property damage.

Follow all local electrical and safety codes as well as in the United States, the National Electrical Codes (NEC), the Occupational Safety and Health Act (OSHA), and the American National Standards Institute (ANSI).

⚠ WARNING The following hazards can occur during the normal use of this product:

HAZARD Risk of explosion or fire - flammable materials		 
WHAT COULD HAPPEN	HOW TO PREVENT IT	
When paints or materials are sprayed, they are broken into very small particles and mixed with air. This will cause certain paints and materials to become extremely flammable and could result in serious injury or death.	<p>Never spray closer than 25 feet to the air compressor! Motors, electrical equipment and controls can cause electrical arcs that will ignite a flammable gas or vapor. Never store flammable liquids or gases in the vicinity of the compressor. If possible, locate the air compressor in separate room. Never spray into compressor, compressor controls or the motor.</p> <p>Never spray near open flames or pilot lights in stoves or heaters.</p> <p>Never smoke or eat while spraying paint, insecticides, or other flammable substances.</p> <p>Provide ample ventilation when spraying indoors.</p> <p>To reduce the risk of static sparking, grounding continuity to the spray equipment and the object being sprayed must be maintained.</p> <p>When spraying and cleaning, always follow the instructions and safety precautions provided by the material manufacturer (Refer to MSDS)</p>	

HAZARD Risk of explosion - incompatible materials		
WHAT COULD HAPPEN	HOW TO PREVENT IT	
Halogenated hydrocarbon solvents such as 1,1,1-Trichloroethane and Methylene Chloride can chemically react with the aluminum used in most spray equipment, and this gun and cup, to produce an explosion hazard and could result in serious injury or death.	<p>Read the label or data sheet for the material you intend to spray.</p> <ol style="list-style-type: none"> Never use any type of spray coating material containing these solvents. Never use these solvents for equipment cleaning or flushing. If in doubt as to whether a material is compatible, contact your material supplier. 	

IMPORTANT SAFETY RULES FOR ALL SPRAY GUNS

SAVE THESE INSTRUCTIONS

HAZARD Risk of breathing		
WHAT COULD HAPPEN	HOW TO PREVENT IT	
<p>Some paints, coatings and solvents may cause lung damage, and burns if inhaled or allowed to come into contact with skin or eyes.</p> <p>Spraying of some organic solvents can cause intoxication and serious damage to health.</p> <p>Do not spray acids, corrosive materials, toxic chemicals, fertilizers or pesticides. Using these materials could result in death or serious injury.</p>	<p>Use a NIOSH approved mask or respirator and protective clothing designed for use with your specific application and spray materials. Some masks provide only limited protection against toxic materials and harmful paint solvent. Consult with a Safety Expert or Industrial Hygienist if uncertain about your equipment or materials.</p> <p>Use the spray gun in well-ventilated areas.</p> <p>Keep visitors away and NEVER allow children or pets in the work area.</p>	

HAZARD Risk of flying objects		
WHAT COULD HAPPEN	HOW TO PREVENT IT	
<p>Certain parts are under pressure whenever the gun is connected to as pressurized air line. These parts may be propelled if the gun is disassembled.</p> <p>Compressed air may propel dirt, metal shavings, etc. and possibly cause an injury and/or damage to the work piece.</p> <p>Prolonged exposure to air spray can result in permanent damage to hearing.</p>	<p>Disconnect the gun from the air line, or completely depressurize the air line whenever the gun is to be disassembled.</p> <p>Never point any nozzle or sprayer toward a person or part of the body.</p> <p>Always wear ANSI Z87.1 safety approved goggles or glasses when spraying.</p> <p>Always work in a clean environment. Do not aim the spray gun at any dust or debris.</p> <p>Always wear hearing protection when operating spray equipment.</p>	

HAZARD Risk of injection		
WHAT COULD HAPPEN	HOW TO PREVENT IT	
<p>Spray guns operate at pressures and velocities high enough to penetrate human and animal flesh, which could result in amputations or other serious injury.</p> <p>See a physician immediately!</p>	<p>Never place hands in front of nozzle.</p> <p>Direct spray away from self and others.</p>	

HAZARD Risk of bursting		
WHAT COULD HAPPEN	HOW TO PREVENT IT	
<p>Exceeding the pressure rating of air tools, spray guns, air operated accessories, tires, and other inflatables can cause them to explode or fly apart, and could result in serious injury.</p>	<p>Do not use pressure that exceeds the operating pressure of any of the parts (hoses, fittings, etc.) in the painting system.</p> <p>Keep hose away from sharp objects. Bursting air hoses may cause injury.</p> <p>Examine air hoses regularly and replace if damaged.</p> <p>Always use a pressure regulator on the air supply to the spray gun.</p>	

WORK AREA SAFETY

⚠ CAUTION Before disassembly or removal of any part of gun or attached components, shut off air supply to gun, shut off air compressor, release pressure from spray gun by depressing trigger, and disconnect power source. NEVER assume system pressure is zero.

⚠ WARNING TO AVOID CREATING AN EXPLOSIVE ATMOSPHERE, WORK ONLY IN WELL VENTILATED AREAS.

⚠ WARNING USE OF A FACE MASK IS RECOMMENDED TO PREVENT INHALATION OF TOXIC MATERIAL.

1. Keep your work area clean and well lit. Clutter and dark areas invite accidents.
2. Do not operate air compressor or other power tools in explosive atmospheres, such as in the presence of flammable liquids, gases, or dust. Electric motors used in these machines create sparks, which may ignite the dust or fumes.
3. Keep pets, bystanders, children and visitors away while operating a spray gun.

ITEM 19000 - FEATURES AND SPECIFICATIONS

- 1) 600ml Plastic Paint Cup
- 2) Fluid Inlet (Optional Material Filter)
- 3) Air Cup
- 4) 1.4mm Fluid Tip (Nozzle)
- 5) Trigger
- 6) Packing Nut (Air Valve)
- 7) Air Control Knob
- 8) Cup Lid
- 9) 1.4mm Fluid Needle
- 10) Fluid Control Knob
- 11) Spray Pattern Control Knob
- 12) 1/4" NPS Air Inlet Fitting
- 13) Pressure Regulator

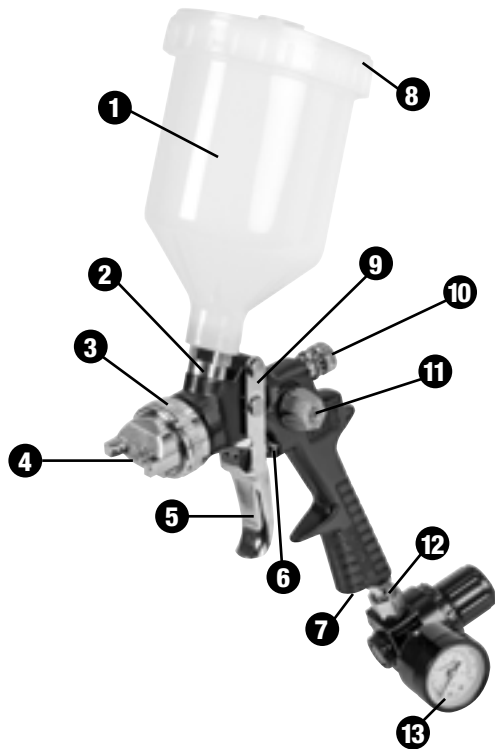

INTRODUCTION

Your new VAPER spray gun is a vital link in the finishing application. In addition to operating the spray gun properly, techniques of surface preparation, paint preparation and the nature of the specific spray material to be used must be understood. These instructions will explain the differences among various spray methods and serve as a guide in the proper operation and techniques of spray painting. Please refer to the Parts section of this manual for model specific information.

TYPES OF SPRAY GUNS

There are three basic types of spray guns: siphon feed, pressure feed and gravity feed. The type of spray gun used depends upon the application and the size of the project. These types of spray guns can be either "conventional" spray or HVLP (High Volume Low Pressure) spray.

Conventional spray guns use a much higher air cap pressure (more than 10 psi) to atomize the paint than is used by HVLP spray guns, which results in more overspray and lower transfer efficiency. (Transfer efficiency refers to the percentage of paint sprayed that actually adheres to the surface being painted).

HVLP, electrostatic and airless paint spray guns are the only spray methods that meet the strict 65% transfer efficiency rate required by some air quality district regulations. This improved transfer efficiency results in a significant material savings when compared to conventional spray guns. Be sure to check local, state and nations regulations that may apply before performing any spraying operations.

In order to qualify as an HVLP spray gun, dynamic air pressure, when measured at the air cap, must not exceed 10 psi. HVLP spray guns produce a soft, low velocity spray pattern which provides increased control while reducing paint "bounce-back" and overspray. As a result, HVLP is also well suited for spraying surfaces with recessed areas.

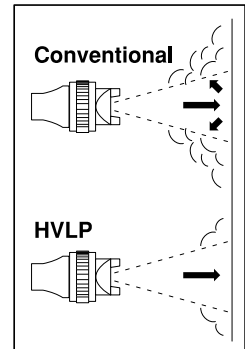

TYPE OF SPRAY GUN HOOKUPS

SIPHON FEED CUP HOOKUP

Air pressure for atomization is controlled by the regulator on the air source. The amount of fluid is adjusted by the fluid control knob on the gun, the paint viscosity, and the air pressure. The siphon cup must be vented to the atmosphere.

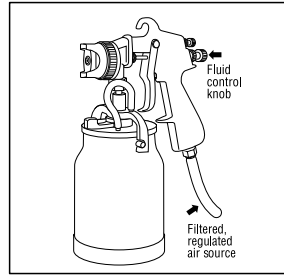

PRESSURE FEED CUP HOOKUP

Air pressure for atomization is controlled by the regulator on the air source. The fluid pressure is set by adjusting the cup regulator. The amount of fluid is also adjusted by the fluid control knob. This method is required for heavy fluids and when using internal mix nozzle spraying. This method generally requires a special fluid tip, needle and air cap set.

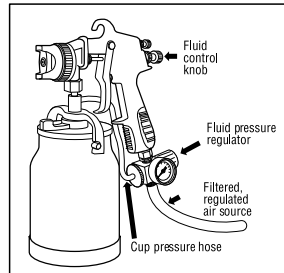

PRESSURE FEED TANK HOOKUP

This method is similar to the pressure feed cup hookup with the added benefit of being able to orient the gun in any position independent of the tank. This method is useful for medium production or large scale spraying applications where large quantities of paint are used.

For medium production spraying (single regulator setup on tank), air pressure for atomization is controlled by the regulator at the air source. The amount of fluid is adjusted by the regulator on the paint pressure tank.

For portable painting operations (double regulator setup on tank), air pressure for atomization and fluid supply is regulated by two individual air regulators on the paint pressure tank.

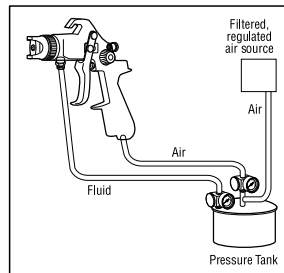
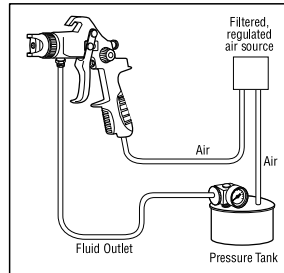

PRESSURE FEED CIRCULATING HOOKUP

For heavy production spraying, air pressure for atomization is controlled by the regulator on the air source. The fluid pressure is regulated by a separate fluid regulator at the paint source.

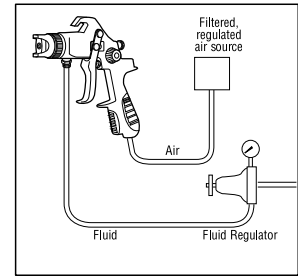

GRAVITY FEED CUP HOOKUP

This popular method is similar to the siphon feed with cup except that the paint cup is mounted above the spray gun. This creates a positive fluid pressure in the fluid nozzle while providing better balance and comfort for the operator.

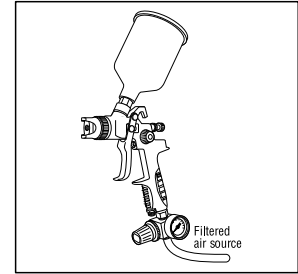

ASSEMBLY

⚠ NOTICE All parts on a spray gun should be screwed in hand tight at first; this will avoid the possibility of cross threading the parts. If the parts cannot be turned by hand easily, make sure you have the correct parts, unscrew by hand easily, make sure you have the correct part, unscrew, realign, and try again. NEVER use undue force in mating parts.

- 1) Connect the paint cup to the fluid inlet nipple and tighten to ensure a good seal, using spanner. Use of the supplied filter screen is optional. This filter helps protect against small particle contaminants. See parts drawing for proper filter placement.
- 2) Wrap the threads on the air inlet nipples of the spray gun and the regulator with a couple of layers of PTFE tape to help prevent air leaks.
- 3) Connect the regulator to the air inlet nipple at the base of the gun handle.
- 4) Connect the air supply to the air inlet nipple on the regulator.

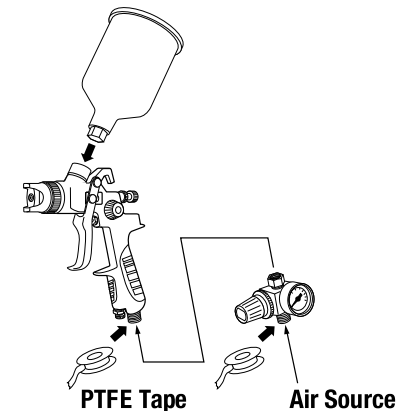

PREPARATION FOR SPRAYING

⚠ WARNING DO NOT ATTEMPT TO UNCLOG (BACK FLUSH) SPRAY GUN BY SQUEEZING TRIGGER WHILE HOLDING FINGER IN FRONT OF FLUID NOZZLE.

⚠ CAUTION Pressure may vary according to viscosity of material used. Maximum working pressure of this gun is 100 psi. DO NOT EXCEED PRESSURE LIMIT OF GUN OR ANY COMPONENT IN THE SYSTEM.

⚠ CAUTION Prior to daily operation, make certain that all connections and fittings are secure. Check hose and all connections for weak or work conditions that could render the system unsafe. All replacement components must have a working pressure equal or greater than the system pressure.

⚠ NOTICE This spray gun was treated with an anticorrosive agent prior to shipment. CAREFULLY FLUSH GUN WITH THINNER BEFORE USE.

WATER AND/OR OIL IN COMPRESSED AIR

All compressor pumps discharge some condensed water, oil or contaminates with the compressed air. IMPORTANT: This condensation will cause “fish eyes” to appear in the paint job. Install appropriate water/oil removal filter equipment and controls as necessary for the intended application.

⚠ NOTICE Failure to install appropriate water/oil removal equipment may result in damage to machinery or work piece.

- 1) Thoroughly mix paint to be sprayed in accordance with the manufacturer’s instructions, adding thinner where necessary.
- 2) Strain material through 60 to 90 mesh screen.
- 3) Fill the paint cup about 3/4 full and attach to paint gun securely.
- 4) Attach air supply to 1/4” NPS inlet.

⚠ CAUTION NEVER point spray gun at self or others. Accidental discharge of material may result in serious injury.

- 5) Start the air compressor
- 6) Adjust air pressure via air supply regulator

⚠ CAUTION DO NOT Exceed 100 psi.

- 7) Prepare a piece of scrap material for use as a spray gun test target.
- 8) Depress spray gun trigger fully to spray material.
NOTE: Depressing trigger partially will cause only air to be released.
- 9) Adjust the air pressure and paint flow to provide a uniform dispersion of atomized paint throughout the pattern. Keep air pressure as low as possible to minimize paint “bounce back” and overspray. Excessive fluid flow will result in a heavy center spray pattern. Inadequate flows will cause the spray pattern to split. Please see the Troubleshooting section of this guide if any problems occur.

FAN DIRECTION

The position of the air cap horns determines the directions of the fan (horizontal or vertical spray pattern). Loosen the lock ring on the air cap and rotate the horns to achieve the desired pattern. Hand tighten lock ring after adjustment.

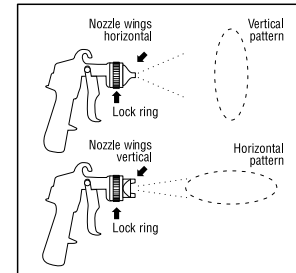

SPRAY PATTERN ADJUSTMENT

SIPHON AND GRAVITY FEED GUNS

- 1) Adjust air pressure to the spray gun according to the recommendations supplied by the spray material manufacturer. This air pressure is typically below 20 psi for HVLP spray guns and between 40 to 60 psi for conventional spray guns. Adjust air pressure with the trigger pulled and the air control knob (if applicable) fully open.
- 2) The width of the “fan spray” is controlled by the pattern control knob. Turn knob counterclockwise to increase the width of the fan spray pattern. Turn knob clockwise to decrease the spread of the fan spray pattern for a round pattern.
- 3) Trigger a short burst while turning fluid control knob until the desired pattern on the test target and adjust the fluid control knob until the desired atomization (spray) pattern is achieved. If the spray is too fine, creating excessive overspray, there is too much air for the amount of paint being sprayed – Reduce the air pressure or open the fluid control to spray more material. If the spray is too coarse, (spitting globs of paint), reduce the amount of material with the fluid control knob or thin the paint.

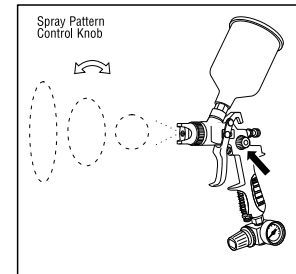

PATTERN ADJUSTMENTS FOR PRESSURE HOOKUPS

- 1) Adjust air pressure to the spray gun according to the recommendations supplied by the spray material manufacturer. This air pressure is typically between 40 to 60 psi for conventional spray guns. Adjust air pressure with the trigger pulled and the air control knob (if applicable) fully open.
- 2) The width of the “fan spray” is controlled by the pattern control knob. Turn knob counterclockwise to increase the width of the fan spray pattern. Turn knob clockwise to decrease the spread of the fan spray pattern for a round pattern.
- 3) Open the fluid control knob by turning counterclockwise about three turns.
- 4) Start the tank pressure at 0 psi and turn the tank regulator slowly to increase fluid delivery until the desired atomization (spray) pattern is achieved.
- 5) If the spray pattern is too coarse, reduce the tank pressure with the tank regulator to reduce the amount of material. Trigger a short burst to relieve the tank pressure, and then increase tank pressure slowly until a proper atomization pattern is achieved.
- 6) The fluid control knob can be used for fine adjustment of the atomization pattern.

▲ NOTICE Before spraying the work piece, practice on a cardboard or other suitable test target to ensure that the spray pattern size and consistency are correct.

GUN HANDLING

For best results, please follow these basic guidelines when spraying:

- 1) Always keep the spray gun perpendicular to the surface being painted.
- 2) Keep the nozzle about 6 to 12 inches from the work surface throughout the stroke.
- 3) Always keep the gun in motion while spraying. Stopping the gun motion in mid-stroke will cause a build up of paint which can cause runs in the finish.
- 4) Do not “fan” the gun in an arcing motion as this creates an uneven finish by producing a build up of paint in the middle portion of the stroke and thinner coating at each end of the stroke.
- 5) Trigger the gun properly – Start the gun moving at the beginning of each stroke BEFORE SQUEEZING THE TRIGGER and release the trigger BEFORE STOPPING GUN MOTION at the end of each stroke.
- 6) The amount of paint being applied to the surface varies due to the speed of the stroke, distance from the work surface, the adjustment of the fluid control knob and the air pressure being used. NOTE: To reduce overspray and maximize efficiency, always spray with the lowest possible atomizing air pressure.
- 7) The material deposited should always be even and wet. Overlap each stroke just enough to obtain a uniform finish.
- 8) Use appropriate masking materials (masking paper, tape, etc.) as needed to protect other surfaces from overspray.

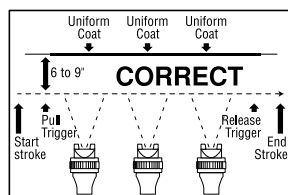
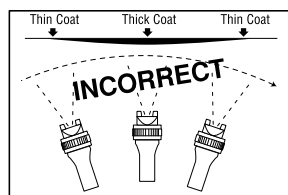

CARE AND MAINTENANCE

▲ WARNING Always wear safety goggles that comply with ANSI standard Z87.1 when cleaning spray guns.

▲ WARNING Always wear a NIOSH approved mask or respirator and approved protective clothing designed for use with the specific solvents you are using.

▲ CAUTION Always exercise extreme care when using a solvent or thinner. Never clean gun near fire, flame, electrical equipment or any source of heat or sparks.

▲ CAUTION DO NOT soak entire spray gun in solvent or thinner for a long period of time as this will destroy lubricants and possibly make motion uneven. NEVER use lye or caustic alkaline solution for cleaning. Such solutions will attack and degrade aluminum alloy parts of gun making it unusable.

DAILY CLEANING

▲ NOTICE Clean spray gun immediately after use. Paint and other spray materials dry quickly in the small passages of the gun rendering it unusable due to the difficulty of removing hardened paint from the passages inside the gun.

▲ NOTICE Local codes may not allow the spraying of paint thinner or solvents. Use a gun washer to clean spray guns in accordance with local codes. Follow manufacturer's instructions for proper use of cleaning equipment and materials. Dispose of used cleaning materials in accordance with local, state and national regulations.

CLEANING SPRAY GUNS WITH PAINT CUPS

- 1) Empty paint cup; then rinse with appropriate solvent recommended by the spray material manufacturer.
- 2) Refill paint cup with cleaning solvent and attach to gun. Spray solvent through the gun while shaking the gun. Wipe the exterior of the gun with a solvent soaked rag. Repeat until the gun is clean.
- 3) Remove the air cap and soak in solvent until clean. Use a small bristle brush for stubborn stains. If it becomes necessary to clean the air cap holes, use a toothpick or small brush. **NEVER USE A METAL WIRE OR OTHER HARD INSTRUMENT TO CLEAN PRECISION DRILLED AIR PASSAGES. DAMAGED AIR PASSAGES WILL CAUSE A DISTORTED SPRAY PATTERN.**
- 4) Clean gaskets with solvent soaked rag. To prevent damage, do not immerse gaskets or spray gun in solvents as this is detrimental to the lubricants and packings.

- 5) After using water to clean out water based paints or materials, spray mineral spirits through the gun to prevent corrosion.
- 6) Lubricate gun after cleaning using light machine oil.

⚠ CAUTION Never use lubricants containing silicone as these lubricants can cause finish defects.

Apply light machine oil to: fluid needle packing, air valve packing, side port control packing and trigger point. Coat fluid control spring and all threaded connections with petroleum jelly prior to storage.

CLEANING SPRAY GUNS USED WITH PAINT TANKS

⚠ WARNING Shut off air supply to paint tank and release pressure in the tank.

- 1) Open the vent on the paint tank. If using an external mix cap, loosen cap slightly.
- 2) Reduce air pressure to 10 to 20 psi. Hold a wadded piece of cloth tightly over the air cap opening(s) and pull the trigger. Air will back up through the fluid nozzle and force fluid out of the hose and back into the tank.
- 3) Pour paint from the tank and clean tank with solvent and rags.
- 4) Pour enough thinner into the tank to clean the hose and gun thoroughly. Close the tank and spray from the gun until the solvent comes out clean.
- 5) Remove fluid hose and blow it out thoroughly to remove all traces of solvent in the hose.

⚠ WARNING When blowing out the hose, the open end should be aimed away from any person to avoid blowing solvent into the eyes or on the skin causing possible injury.

AIR NOZZLE, FLUID TIP, NEEDLE ASSEMBLY

⚠ CAUTION To prevent damage to the fluid tip of fluid needle, be sure to either: 1) pull the trigger and hold while tightening or loosening the fluid tip, or 2) remove fluid needle adjusting screw to relieve spring pressure against needle collar.

- 1) All nozzles and needles are precision made and should be handled with care.
- 2) Except as described in “Fluid Needle Adjustment”, do not make any alterations in the gun. To do so will cause finishing difficulties.
- 3) To clean nozzles, soak them in solvent to dissolve any dried material, then blow them clean with compressed air.
- 4) Do not probe any of the holes in the nozzles with metal instruments. If probing is necessary, use only a tool that is softer than brass.

FLUID NEEDLE ADJUSTMENT

- 1) Remove the fluid control assembly.
- 2) Pull the needle assembly out approximately 1-1/4”
- 3) Loosen the needle cap.
- 4) Screw the needle assembly locknut out for more trigger movement, in for less trigger movement.
- 5) Adjust the needle assembly so that when the trigger moves, the air valve assembly moves 1/16” to 3/32” before the needle assembly moves.
- 6) Tighten the needle cap.

⚠ CAUTION Over tightening may damage the threads, which will make future adjustments difficult.

- 7) Reassemble.



O-RINGS, SEALS AND PACKING NUTS

- 1) Check and replace any damaged O-rings and seals. O-rings and seals can be wiped clean but not soaked in solvent.
- 2) Unscrew packing nuts and replace the packing ONLY if a leak will not stop when the nut is tightened. Do not over tighten a packing nut as this will restrict movement of the needle.
- 3) Reassemble in reverse order of above and use light machine oil to lubricate moving parts.

STORAGE

- 1) When not in use, turn the fluid adjustment knob counterclockwise to open and reduce the spring tension on the needle fluid tip.
- 2) Spray gun **must be** cleaned and lightly lubricated prior to storage.

TROUBLESHOOTING

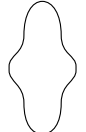
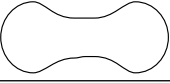
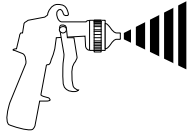
Problem Encountered	Possible Cause	Corrective Action
Heavy top or bottom pattern 	Horn holes plugged. Obstruction on top or bottom of fluid tip. Cap and/or tip seat dirty.	Clean. Ream with non-metallic point. Clean. Clean.
Heavy right or left side pattern 	Left or right side horn holes plugged. Dirt on left or right side of fluid tip.	Clean. Ream with non-metallic point. Clean.
Heavy center pattern 	Fluid pressure too high for atomization air (pressure feed). Material flow exceeds air caps capacity. Spreader adjustment valve set too low. Material too thick.	Balance air and fluid pressure. Increase spray pattern width with spreader adjustment valve. Thin or lower fluid flow. Adjust. Increase pressure. Thin to proper consistency.
Split spray pattern 	Atomization air pressure too high. Fluid pressure too low (pressure feed only). Spreader adjusting valve set too high.	Reduce at regulator or gun. Increase fluid pressure (increases gun handling speed). Adjust.
Jerky or fluttering pattern 	Loose or damaged fluid tip/seat. Material level too low. Container tipped too far. Obstruction in fluid passage. Loose or broken fluid tube or fluid inlet nipple. Dry or loose fluid needle packing nut.	Tighten or replace. Refill. Hold more upright. Back flush with solvent. Tighten or replace. Lubricate or tighten.
Unable to get round spray	Spreader adjustment screw not seating properly. Air cap retaining ring loose.	Clean or replace. Tighten.
Will not spray.	No air pressure at gun. Internal mix or pressure feed air cap and tip used with suction feed. Fluid pressure too low with internal mix cap and pressure tank. Fluid needle adjusting screw not open Fluid tool heavy for suction feed.	Check air supply and air lines. Change to proper suction feed air cap and tip. Increase fluid pressure at tank. Open fluid needle adjusting screw. Thin material or change to pressure feed.
Starved spray pattern.	Inadequate material flow. Low atomization air pressure (suction feed). Too much atomization air pressure.	Back fluid adjusting screw out to first thread or increase fluid pressure at tank. Increase air pressure and rebalance gun. Reduce pressure.

TROUBLESHOOTING (Continued)

Problem Encountered	Possible Cause	Corrective Action
Excessive overspray.	Gun too far from work surface. Improper stroking (arcing, gun motion too fast).	Adjust to proper distance. Move at moderate rate pace, parallel to work surface.
Excessive fog	Too much, or too fast-drying thinner. Too much atomization air pressure.	Remix properly. Reduce pressure.
Dry spray.	Air pressure too high. Gun tip too far from work surface. Gun motion too fast. Gun out of adjustment.	Reduce air pressure. Adjust to proper distance. Slow down. Adjust.
Fluid leaking from packing nut.	Packing nut loose. Packing worn or dry.	Tighten, do not bind needle. Replace or lubricate.
Fluid leaking or dripping from front of pressure feed gun.	Packing nut too tight. Dry packing. Fluid tip or needle worn or damaged. Foreign matter in tip. Fluid needle spring broken. Wrong size needle or tip.	Adjust. Lubricate. Replace tip. Clean. Replace. Replace.
Runs and sags.	Too much material flow. Material too thin. Gun tilted on an angle, or gun motion too slow.	Adjust gun to reduce fluid pressure. Mix properly or apply light coats. Hold gun at right angle to work and adapt to proper gun technique.
Thin, sandy coarse finish drying before it flows out.	Gun too close to surface. Too much air pressure. Improper thinner being used.	Check distance. Normally about 8". Reduce pressure and check spray pattern. Follow paint manufacturer's mixing instructions.
Thick, dimpled finish "orange peel"	Gun too close to surface. Too much material coarsely atomized. Air pressure too low. Improper thinner being used. Material not properly mixed. Surface rough, oily or dirty.	Check distance. Normally about 8". Increase air pressure or reduce fluid pressure. Increase air pressure or reduce fluid pressure. Follow paint manufacturer's mixing instructions. Follow paint manufacturer's instructions. Properly clean and prepare surface.

ITEM 19000 - PARTS BREAKDOWN

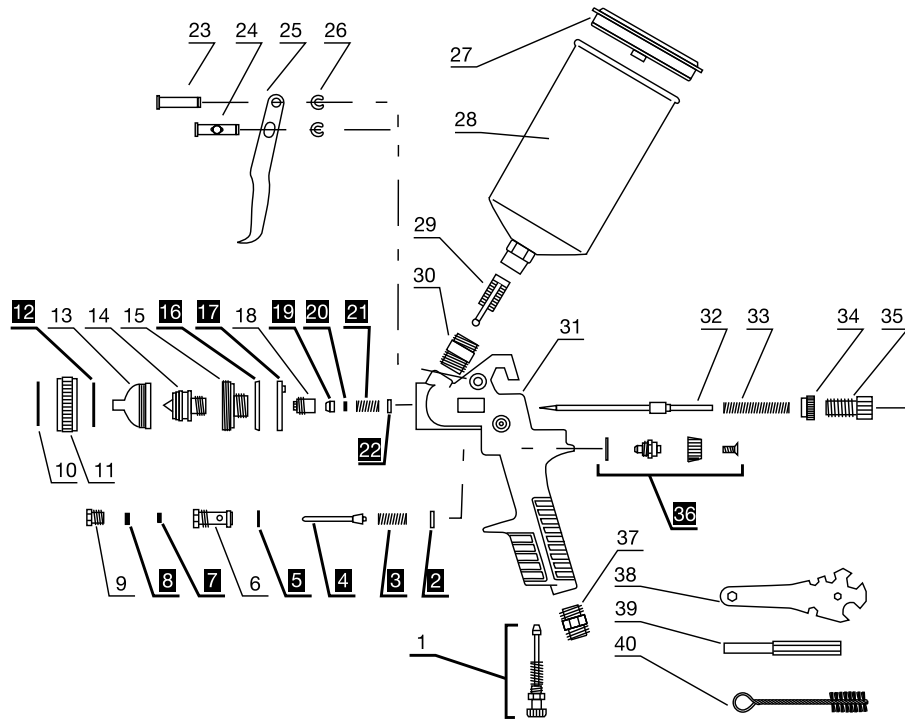

Rebuild Kit available for this Spray Gun: Part #19908
Numbers highlighted in black are included in rebuild kit

Ln #	Description	Qty
1	Air Adjustment Valve	1
2	Gasket	1
3	Air Valve Spring	1
4	Air Valve Piston Shaft	1
5	O-Ring	1
6	Air Valve Seat	1
7	O-Ring	1
8	Pliable Packing Washer	1
9	Air Valve Packing Nut	1
10	Air Cap Retention Ring	1
11	Air Cap Locking Ring	1
12	Air Cap Washer	1
13	Air Cap	1
14	Fluid Nozzle	1
15	Air Manifold	1
16	Tapered Washer	1
17	Air Manifold Spacer	1
18	Retention Screw	1
19	Paint Needle Washer	1
20	Sealing Washer	1

Ln #	Description	Qty
21	Locking Spring	1
22	Gasket	1
23	Trigger Pin- Pivot	1
24	Trigger Pin- Fluid Needle	1
25	Trigger	1
26	Retaining Ring	2
27	Lid	1
28	Cup	1
29	Fluid Filter	1
30	Fluid Inlet Fitting	1
31	Gun Body	1
32	Fluid Needle	1
33	Fluid Needle Spring	1
34	Fluid Adjustment Locking Ring	1
35	Fluid Adjustment Knob	1
36	Pattern Adjustment Value	1
37	Air Inlet Fitting	1
38	Gun Wrench	1
39	Internal/External Hex Wrench	1
40	Brush	1

HVLP GRAVITY FEED SPRAY GUN TIP SIZE APPLICATION GUIDE

Tip Size	Common Applications
Touch-Up Gun	
1.0	For most fine finishing. Spot repairs and detail painting with primer, base coats, clear coats, single stages, low VOC.
Production Guns	
1.3	Clear coats, base coats, water based coatings and single stages. Produces a fine finish.
1.4	A good all-purpose tip suitable for general materials including single stages, base coats, water based coatings, clear coats. This larger tip works well with thicker clear materials.
1.5	A versatile tip for base coats and single stages. Potential risk of orange peel if used to spray clear coats. Tip can also be used to spray primer sealers, conversion varnish, water base clears and lacquers.
1.7	Widely used for primer, this tip is well suited for coating larger surfaces, thick layers and spotted effects. Will apply thick primer quickly. Best suited for thicker materials such as flakes, heavy solid materials, primer, primer sealers, polyester primers, varnish, polyurethane, oil base paints, enamels, epoxy, plastic adhesives, floor paving paints, latex, splatter paints, multi-fleck, etc.
2.0	This large tip is suitable for heavy solid materials such as: surface primer, primer sealers, polyester primers, rust proof coatings and industrial finish coatings.
2.3	Very large tip designed for heavy flows and fast coverage. Commonly used for high build primers, fiberglass resins, epoxy, stone finish paints, texture coatings, industrial primers, latex, etc.

Always consult your paint supplier for specific manufacturer's application guidelines. Tip size recommendations serve as a starting reference only and are not intended as a specific application guide for all coating material brands. They are not meant to imply that any given air cap and fluid tip combination cannot be used to successfully spray a given coating material. Spraying technique and personal preference must also be considered.

SPRAY GUNS AND ACCESSORIES AVAILABLE FROM VAPER



For up-to-date product information, and for a Spanish version of this manual, please visit our website at: www.titan-us.com and click on "Literature" or scan the QR Code at left with your smart phone.

For other spray guns and accessories please visit our website at: www.titan-us.com

90 DAY LIMITED WARRANTY

Star Asia-USA, LLC (hereinafter "seller") warrants to the original purchaser only, that this product will be free from defects in material or workmanship for a period of 90 days from date of purchase for home domestic use.

Warranty Performance

Warranty coverage is conditioned upon purchaser furnishing seller or its authorized service center with adequate written proof of the original purchase date. Products returned, freight prepaid and insured, to our factory or to an Authorized Service Center will be inspected and repaired or replaced, at seller's option, free of charge if found to be defective and subject to warranty. Defective parts not subject to normal wear and tear will be repaired or replaced, at our option during the above stated warranty periods. In any event, reimbursement is limited to the purchase price paid. Other than the postage and insurance requirement, no charge will be made for repairs or replacements covered by this warranty. Under no circumstances shall the manufacturer bear any responsibility for loss of the unit, loss of time or rental, inconvenience, commercial loss or consequential damages. There are no warranties which extend beyond the description of the face herof.

Exclusions

This warranty does not cover parts damaged due to normal wear, abnormal conditions, misapplication, misuse, abuse, accidents, operation at other than recommended pressures or temperatures, improper storage of freight damage. Parts damaged or worn by operation in dusty environments are not warranted. Failure to follow recommended operating and maintenance procedures also voids warranty.

Additional items not covered under warranty: product failure caused by rain, excessive humidity, corrosive environments or other contaminants; cosmetic defects that do not interfere with product's functionality.

This warranty shall not apply when: the product has been used for commercial or rental purposes; defects in materials or workmanship or damages result from repairs or alterations which have been made or attempted by others or the unauthorized use of nonconforming parts; this damage is due to abuse, improper maintenance, neglect or accident; or the damage is due to use of the product after partial failure or use with improper accessories. Warranty does not apply to accessory items such as polishing bonnets, saw blades, drill bits, router bits, sandpaper, grinding wheels and other related power tool accessories.

Seller will not be liable for: labor charges, loss or damage resulting from improper operation, maintenance or repairs made by persons other than a Star Asia-USA, LLC Authorized Service Center.

The use of other than genuine Star Asia-USA, LLC Repair Parts will void warranty.

Warranty Disclaimers

NO WARRANTY, ORAL OR WRITTEN, OTHER THAN THE ABOVE WARRANTY IS MADE WITH REGARD TO THIS PRODUCT, ANY IMPLIED WARRANTIES OF SELLER REGARDING THIS PRODUCT INCLUDING BUT NOT LIMITED TO, THE IMPLIED WARRANTIES OF MERCHANTABILITY OR FITNESS FOR A PARTICULAR PURPOSE, ARE EXCLUDED. BUYER'S OR USER'S REMEDIES ARE SOLELY AND EXCLUSIVELY AS STATED ABOVE. STAR ASIA-USA, LLC SHALL IN NO EVENT BE LIABLE FOR INCIDENTAL, CONSEQUENTIAL, INDIRECT, OR SPECIAL DAMAGES. IN NO EVENT, WHETHER AS A RESULT OF A BREACH OF CONTRACT, WARRANTY, TORT (INCLUDING NEGLIGENCE) OR OTHERWISE, SHALL SELLER'S LIABILITY EXCEED THE PRICE OF THE PRODUCT WHICH HAS GIVEN RISE TO THE CLAIM OR LIABILITY. ANY LIABILITY CONNECTED WITH THE USE OF THIS PRODUCT SHALL TERMINATE UPON THE EXPIRATION OF THE WARRANTY PERIODS SPECIFIED ABOVE.

Limitations on Warranty Disclaimers

Any implied warranties shall be limited in duration to 90 days from the date of purchase. In some states of the U.S.A. and in some provinces of Canada there is no limitation for how long an implied warranty is valid, so the aforementioned limitation may not apply to you.

In no event shall a seller be liable for any incidental or consequential damages (including but not limited to liability for loss of profits) arising from the sale or use of this product. In some states of the U.S.A. and in some provinces of Canada the exclusion or limitation of incidental or consequential damages is not allowed, so that aforementioned limitation or exclusion may not apply to you.

This Limited warranty gives you specific legal rights, and you may also have other rights which vary from state to state in the U.S.A., Canada and the Commonwealth of Puerto Rico. For warranty coverage within other countries, contact your local star Asia-USA, LLC dealer or importer.

Distributed by Star Asia-USA, LLC
P.O. Box 58399, Renton, WA 98058
Consumer Service: 800-386-0191
e-mail: info@titan-us.com
©2015 Star Asia-USA, LLC