

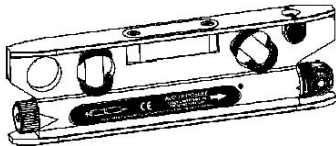

Magnetic Torpedo Laser Level
Model No. 40-6164



Instruction Manual

Congratulations on your choice of this Magnetic Torpedo Laser Level. We suggest you read this instruction manual thoroughly before using the instrument. Save this instruction manual for future use.

This tool emits one laser beam that is selectable as a point, vertical line, or horizontal line. Visibility of the beam depends upon lighting conditions in the work area.

This is a Class IIIa laser tool and is manufactured to comply with CFR 21, parts 1040.10 and 1040.11 as well as international safety rule IEC 285.

Table of Contents

1. Kit Contents	7. Using the Product
2. Features and Functions	8. Technical Specifications
3. Safety Instructions	9. Application Demonstrations
4. Location/Content of Warning Labels	10. Care and Handling
5. Location of Parts/Components	11. Product Warranty
6. Operating Instructions	12. Product Registration
	13. Accessories

1. Kit Contents

<u>Description</u>	<u>Qty.</u>
Magnetic Torpedo Laser Level	1
“AAA” Alkaline Batteries	2
Instruction Manual with Warranty Card	1
Soft-sided Carrying Case	1

2. Features and Functions

- Able to project laser point
- Able to project a horizontal laser line
- Able to project a vertical laser line
- Magnetic bottom allows unit to be attached to metal
- Available for operation by mounting on tripod

3. Safety Instructions

Please read and understand all of the following instructions, prior to using this tool. Failure to do so, may result in bodily injury.

DANGER!

Class IIIa Laser Product
Max. Power Output: $\leq 5\text{mW}$
Wavelength: 640-660nm

**THIS TOOL EMITS LASER RADIATION.
DO NOT STARE INTO BEAM.
AVOID DIRECT EYE EXPOSURE.**

**ATTENTION****IMPORTANT**

- Read all instructions prior to operating this laser tool. Do not remove any labels from tool.
- Use of controls or performance of procedures other than those specified herein may result in hazardous radiation exposure.
- Do not stare directly at the laser beam.
- Do not project the laser beam directly into the eyes of others.
- Do not set up laser tool at eye level or operate the tool near a reflective surface as the laser beam could be projected into your eyes or into the eyes of others.
- Do not place the laser tool in a manner that may cause someone to unintentionally look into the laser beam. Serious eye injury may result.
- Do not operate the tool in explosive environments, i.e. in the presence of gases or flammable liquids.
- Keep the laser tool out of the reach of children and other untrained persons.
- Do not attempt to view the laser beam through optical tools such as telescopes as serious eye injury may result.
- Always turn the laser tool off when not in use or left unattended for a period of time.
- Remove the batteries when storing the tool for an extended time (more than 3 months) to avoid damage to the tool should the batteries deteriorate.
- Do not attempt to repair or disassemble the laser tool. If unqualified persons attempt to repair this tool, serious injury may result.
- Use only original AccuLine Pro™ parts and accessories purchased from your AccuLine Pro authorized dealer. Use of non-AccuLine Pro parts and accessories will void warranty.

CAUTION: If using this product with any type of tinted goggles, please note safety warning below.

WARNING!

The tinted goggles are designed to enhance the visibility of the laser beam. They DO NOT offer protection to the eyes from direct exposure of the laser beam.



4. Location/Content of Warning Labels



Mfg. for Johnson Level & Tool Mfg. Co., Inc.
6333 W. Donges Bay Rd., Mequon, WI 53092
Manufactured in China by JLT05
Date (m/y): _____



5. Location of Part/Components

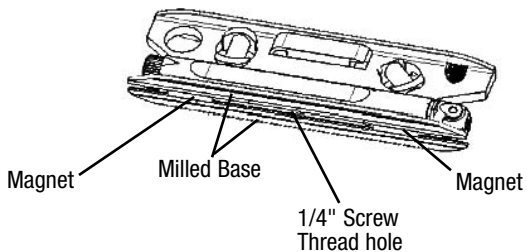
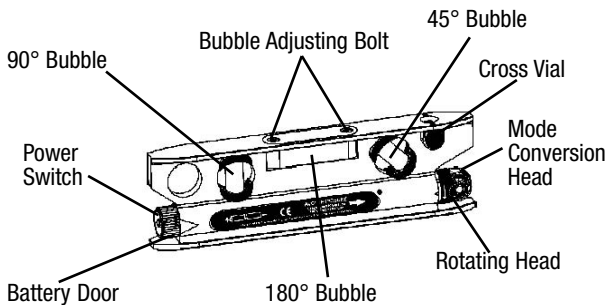

6. Operating Instructions

IMPORTANT: It is the responsibility of the user to verify the calibration of the instrument before each use.

Battery Installation

Remove battery door by rotating it counter-clockwise, and put in two alkaline “AAA” batteries according to the illustrated polarity requirements, and then install the battery door by rotating it clockwise.

Note: Do not charge alkaline batteries to avoid explosion. Used (discharged) batteries are hazardous waste and should be disposed of properly.

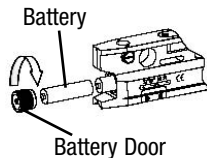

7. Using the Product

Power On/Off

1. Press power switch to project laser line or point.
2. Press power switch again to shut off laser output.

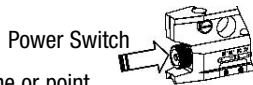

Switch Between Laser Point and Laser Line

1. Turn the mode conversion knob to switch between laser line and laser point. Rotating the wedge lens up or down converts laser from a dot to a line, or line to a dot. Rotating wedge lens counter-clockwise, while in line mode, rotates line from horizontal to vertical, or visa versa.

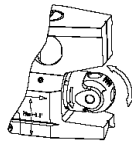

Rotate to switch between point and line

2. Under laser line output mode, turning the rotating head can change the output angle of laser line.

Note: The rotating head can be turned only in the direction indicated by arrowhead sign

Rotatable Line Status

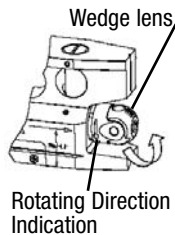

8. Technical Specifications

Laser Wavelength	650nm \pm 10
Laser Classification	Class IIIa
Maximum Power Output	\leq 5mW
Accuracy	\pm 1/8"/50 ft. (\pm 1mm/5m) in the horizontal direction of laser point
Working Range	Maximum 100 ft. (30m) depending upon light conditions
Power Supply	2 "AAA" alkaline batteries
Dimensions	7-1/2" x 2-1/8" x 3/4" (190 x 55 x 20mm)
Weight	0.7 lbs. (0.3 Kg)
Working Temperature	14°F to 113°F (-10°C to +45°C)
Center Screw Thread	1/4" - 20

9. Application Demonstrations

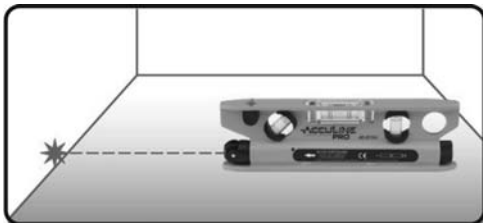

Projects one laser point

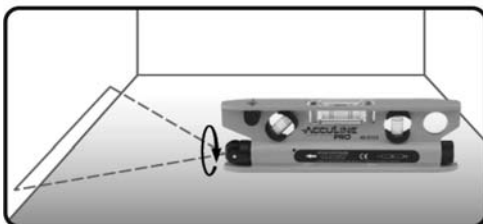

Projects one horizontal laser line

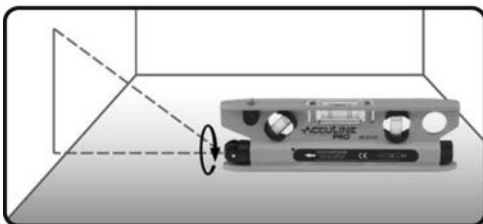

Projects one vertical laser line

10. Care and Handling

- This laser unit is a precision tool that must be handled with care.
- Avoid exposing unit to shock vibrations and extreme temperatures.
- Before moving or transporting the unit, make sure that the unit is turned off.
- Remove the batteries when storing the unit for an extended time (more than three months) to avoid damage to the unit should the batteries deteriorate.
- Always store the unit in its case when not in use.
- Avoid getting the unit wet.
- Keep the laser unit dry and clean, especially the laser output window. Remove any moisture or dirt with a soft, dry cloth.
- Do not use harsh chemicals, strong detergents or cleaning solvents to clean the laser unit.

11. Product Warranty

Johnson Level & Tool offers a one year limited warranty on each its products. You can obtain a copy of the limited warranty for a Johnson Level & Tool product by contacting Johnson Level & Tool's Customer Service Department as provided below or by visiting us online at www.johnsonlevel.com. The limited warranty for each product contains various limitations and exclusions.

Do not return this product to the store/retailer or place of purchase. Required repair/calibration must be done by an authorized AccuLine Pro™ service center or Johnson Level & Tool's limited warranty, if applicable, will be void and there will be NO WARRANTY. Contact our Customer Service Department to obtain a Return Material

Authorization (RMA) number for return to an authorized service center.
Proof of purchase is required.

NOTE: The user is responsible for the proper use and care of the product.

It is the responsibility of the user to verify the calibration of the instrument before each use.

For further assistance, or if you experience problems with this product that are not addressed in this instruction manual, please contact our Customer Service Department.

In the U.S., contact Johnson Level & Tool's Customer Service Department at 800-563-8553.

In Canada, contact Johnson Level & Tool's Customer Service Department at 800-346-6682.

12. Product Registration

Enclosed with this instruction manual you will find a warranty card to be completed for product warranty registration. Product warranty registration can also be completed online at our web site www.johnsonlevel.com. You will need to locate the serial number for your product that is located at the side of the torpedo level. **PLEASE NOTE THAT IN ADDITION TO ANY OTHER LIMITATIONS OR CONDITIONS OF JOHNSON LEVEL & TOOL'S LIMITED WARRANTY, JOHNSON LEVEL & TOOL MUST HAVE RECEIVED YOUR PROPERLY COMPLETED WARRANTY CARD WITHIN 30 DAYS OF YOUR PURCHASE OF THE PRODUCT OR ANY LIMITED WARRANTY THAT MAY APPLY SHALL NOT APPLY AND THERE SHALL BE NO WARRANTY.**

13. Accessories

AccuLine Pro™ accessories are available for purchase through authorized AccuLine Pro dealers. Use of non-AccuLine Pro accessories will void any applicable limited warranty and there will be **NO WARRANTY**. If you need any assistance in locating any accessories, please contact our Customer Service Department.

In the U.S., contact Johnson Level & Tool's Customer Service Department at 800-563-8553.

In Canada, contact Johnson Level & Tool's Customer Service Department at 800-346-6682.

