



US9425739 (12-15)

Operator's Manual & Parts List

425, 425-101, 425-HD, 425-L, 425-PAF, 475-B, 475-101, 475-PAF, 435, 478-SSH, 485, 473-P, 473-D, 473-ECS, 425-Deluxe, and 475-B Deluxe

**STOP!**

If you are missing parts, instructions or have questions, DO NOT take this unit back to the store. Call 1-800-SOLO-INC (1-800-765-6462). Solo will send the missing parts/information to you promptly.

WARRANTY:

Solo backpack sprayers are covered by Solo's 1-YEAR LIMITED WARRANTY. Solo manufactured parts which fail due to defective material or workmanship will be repaired or replaced without charge. See page 5 for full details and complete warranty information.

MAINTENANCE TIP: The cap gasket (#4061345) is prelubricated for improved sealing. Occasional lubrication with Solo Superior Grease (#9850-P) or petroleum jelly is recommended.

SAFETY PRECAUTIONS:

1. Before using sprayer with chemicals, fill sprayer with fresh water to assure that you have it properly assembled; pressurize and practice spraying. Also, check for any leaks at this time. When thoroughly familiar with the sprayer operation, follow normal operating procedures.
2. Ensure all pressure in the sprayer is relieved by locking the shut-off valve in the open position.
3. Avoid contact with chemicals.
4. **Always wear rubber gloves, safety goggles and appropriate protective clothing.**
5. Work in a well ventilated area.
6. Individuals should be trained in the proper use of this sprayer, chemical handling procedures, and first aid/emergency care. Where training is not available, individuals should study and follow the procedures detailed in this manual.

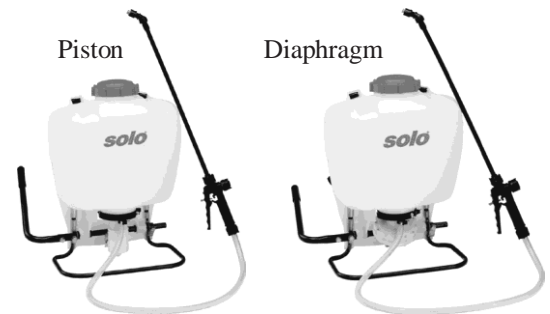

WARNING:

Chemicals can be harmful to individuals and the environment if improperly used. In addition, some chemicals are caustic, corrosive or poisonous and should be avoided. Read warnings and chemical manufacturers' instructions. Solo high density polyethylene sprayers are fitted with chemical resistant seals which are compatible to a wide variety of agricultural and household chemicals; however, care should be exercised to ensure that sprayer components are clean, functioning properly, and in a good state of repair before and during use. If in doubt about a particular chemical, check with the manufacturer. If you suspect or observe indications that the material may be unsafe in a Solo sprayer...**STOP. DO NOT USE OR APPLY CHEMICAL. ALWAYS WEAR RUBBER GLOVES, GOGGLES, AND APPROPRIATE PROTECTIVE CLOTHING!**

- Read and follow operating instructions.
- **Do not fill with, use, or spray flammable materials.**
- Do not modify sprayer.
- Never spray in the direction of humans, animals or property which might be injured or damaged by spray formula.
- Do not use disinfectants, solvents or impregnating agents unless first tested to ensure they are not harmful to the environment or sprayer.
- Do not use liquids with a temperature above 110°F (43°C).
- Wear appropriate protective clothing to prevent contact with chemical agents.
- Rinse and clean sprayer thoroughly after using. Disposal of contaminated rinse should be in accordance with applicable ordinances. Observe the precautionary instructions of the chemical manufacturer.
- **Do not use any acid (including citrus) or caustic chemicals. For bleach solutions, try our Solo 475-B or 475-B Deluxe sprayers.**
- Remember that a sprayer with liquid is a significant amount of weight (8 lbs. per gallon). Do not climb when wearing the sprayer. Use caution when bending, leaning or walking. Bend at the knees rather than the waist.
- During sprayer operation, the pressure cylinder (#4400240) contains compressed air and liquid. Compressed air and liquid under pressure are inherently dangerous. Before making adjustments on sprayers fitted with a pressure regulating valve assembly (#4800182) located on the pressure cylinder or any other repair or inspection of any sprayer, be sure to relieve pressure through the shut-off valve and wand.

CUSTOMER SERVICE COMMITMENT FROM SOLO'S SERVICE DEPARTMENT

In the event the sprayer you have purchased has missing or damaged parts, please call 1-800-765-6462, 9:00 AM - 5:00 PM EST.

In order to assist your service representative, please have the following information available: sprayer model number, part description and part number. A parts list is included in your operator's manual.

Solo is committed to your satisfaction and is continuing its efforts to earn your future business.

Visit us on the web at www.solousa.com
Troubleshooting and parts ordering available on-line.

REMOVING PLASTIC ADJUSTABLE NOZZLE

Unscrew the nozzle cap (1) from the nozzle body (3). This is best accomplished while the retaining nut (2) is fastened tightly to the elbow (5). Next, unscrew the retaining nut (2). Push the nozzle body (3) out of the retaining nut (2). The filter with gasket (4) will come out with the body. To reinstall the nozzle, reverse the above instructions.

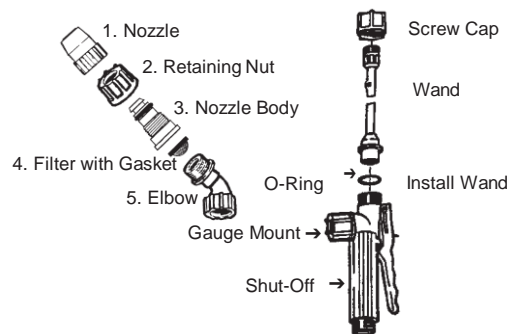

ASSEMBLY INSTRUCTIONS FOR WAND

1. Insert wand into shut-off valve as shown.
2. Tighten the screw cap clockwise onto the shut-off valve.

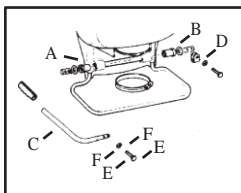

PUMP LEVER INSTALLATION: All hardware necessary for pump lever installation is included with the sprayer. The pump lever (C) should be installed as follows: place lever handle (C) onto the shaft (A). Align bolt holes and install the two bolts (E) and washers (F); then tighten. To install pump lever on the opposite side on a Diaphragm Pump sprayer, remove the stop plate (D) and washer, install the pump lever as above. The stop plate (D) should be mounted on the inner bolt hole with the closed end of the stop plate pointing downward on the opposite side of the pump shaft.

FOLD-AWAY PUMP HANDLE INSTALLATION (FOR SELECT MODELS ONLY):

1. Remove bolt and nut from pump handle.
2. Slide handle assembly over the pump rod and align the holes so that the rear (elbow) portion of the handle points up and slightly forward (approximately 45 degrees) and away from the Solo logo. Reinstall bolt and locknut. Pump handle can be installed on the opposite side of the sprayer for right hand pumping. (For Diaphragm Pump Sprayer, stop plate will need to be relocated to the left side.)
3. The handle can be rotated to either down (pumping) or up (storage) positions. Note: The handle swings away from the sprayer, then up or down as desired. The spray wand attaches to the clamps on the handle assembly for storage (does not apply to the brass or stainless steel wands).

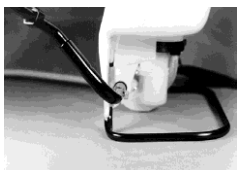
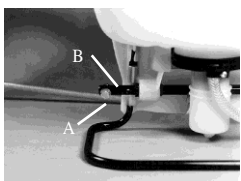

SHOULDER STRAP INSTALLATION:

The top of the shoulder straps are pre-attached to the sprayer by means of a buckle or pin. The lower end of the straps are attached by fastening the strap hooks to the metal frame between where the frame exits the plastic tank and where the frame makes a bend.



REGULATING THE PRESSURE: (FOR DELUXE MODELS ONLY)

The Solo backpack sprayer is equipped with a built-in regulator to control output pressure. This regulator is operator adjustable. Make adjustments prior to filling tank. To adjust the regulator, remove the tank cap and the filter basket. Look inside the spray tank; you will see the top of the regulator. There are 4 fingers on the regulator knob. The finger farthest to the left is #1; to the right is #4. They are numbered 1, 2, 3, 4. 1 = 15 psi, 2 = 30 psi, 3 = 45 psi, 4 = 60 psi. The higher the pressure, the more chemical applied from the sprayer in a given amount of time, but the droplets will be smaller with more drift. If the spray pressure must be changed, excess pressure in the pressure cylinder must be released back into the tank through the spray tube. To adjust, push down on the knob and rotate to align the desired number with the alignment pin. To operate the 425-DELUXE and 435 at higher than 60 psi, first release the excess pressure and then replace the pressure control valve with the optional plug (#4200215).

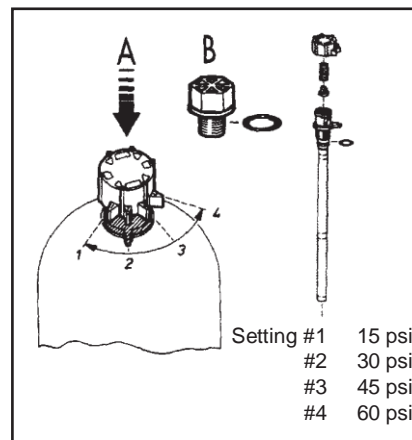





FILLING:

Mix the spray formula and the proper volume of water in a separate container. Pour the mix through the filter basket in the tank opening. This keeps debris from entering the sprayer. Pump the sprayer handle to prime the pump and pressurize the pressure cylinder. The volume of liquid in the sprayer tank will appear to decrease as the pressure cylinder is pressurized. Remember that it's not necessary to completely fill the sprayer tank each time. Mix only the amount needed to get the job done. Chemicals should not be stored in the sprayer.

Always read and carefully follow the manufacturer's instructions printed on the product label. This can save money and help prevent injury and crop and environmental damage.

OPERATING FEATURES:

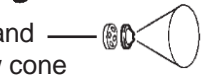
Nozzles - Your Solo sprayer can provide a variety of spray patterns with the standard and optional nozzle arrangements.

Item	Application	Part #
Flat spray nozzle 	Row treatment	4074263
Jet stream nozzle 	Spot & longer range	4074755
Jet stream nozzle and Swirl plate = hollow cone 	Shrubs and bushes	4074755 4074756
Plastic adjustable nozzle 	Spot, shrubs & bushes	4900527
Speed Tip Nozzle 	Row, spot, shrubs & bushes	4074666

SPRAY TIP ASSEMBLY

1. Flat spray nozzle
2. Filter
3. Jet cap
4. Swirl plate
5. Nozzle cap
6. Nozzle body
7. Brass adj. nozzle*
8. Nozzle retaining nut
9. Elbow

NEW Solo Speed Tip Nozzle*
(attaches directly to the wand)

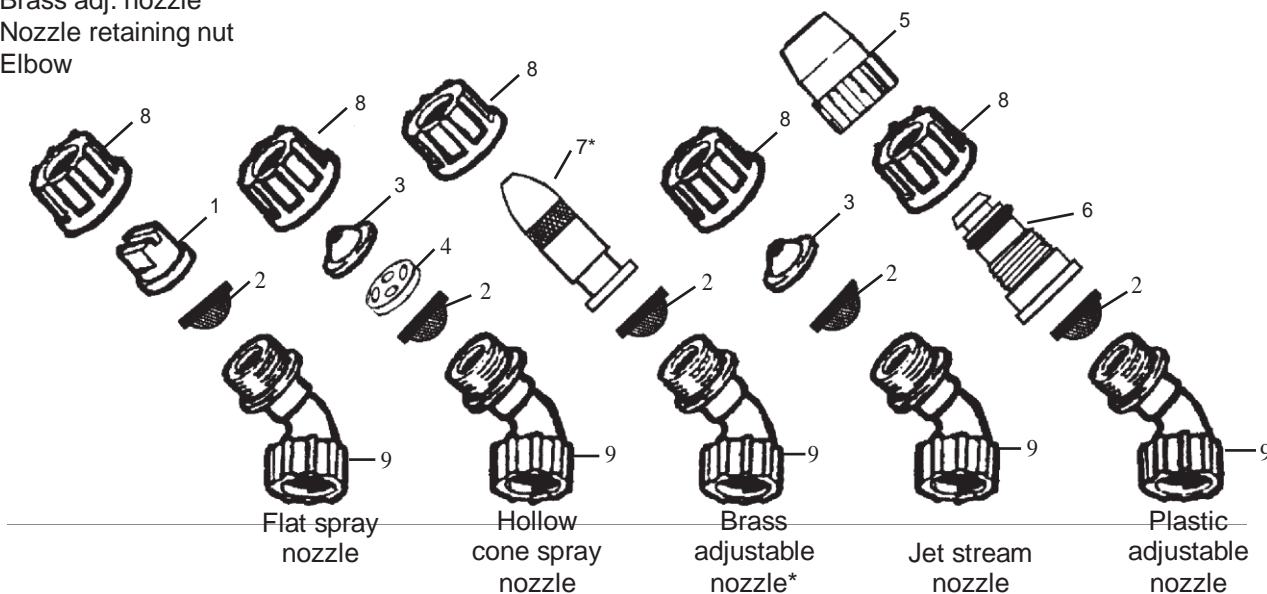

*Brass adjustable nozzle and Speed Tip nozzle are not standard items on all Solo sprayers but each may be purchased as an accessory. Spray tips should be assembled as above for desired spray pattern.

WARNING: Handling the brass parts of this product will expose you to lead, a chemical known by the State of California to cause birth defects and other reproductive harm and/or cancer. Wash hands after handling.

SPRAYING:

Prime the pump with rapid pump strokes. When you feel very firm resistance, the pressure chamber is filling with liquid. With repeated piston strokes, the air in the pressure chamber is slowly compressed. In a safe area, point the wand upward and press the shut-off valve lever spraying for 10 seconds or until no air and only liquid is coming out. This will bleed all of the air out of the hose and wand. By pressing the hand lever, the valve opens, and liquid is forced through the nozzle. The shut-off valve has a retaining clip which keeps the valve in the "OPEN" position for continuous operation. Pump using the end of the pump handle, as it is less fatiguing. The volume of liquid delivered varies with the working pressure which should be as high as needed to ensure an adequate spray pattern for each individual application.

NOTE: Should the pressure drop very quickly, drain the tank completely and pump without liquid. By this procedure, the air chamber is refilled with the required volume of air. It is advisable to pump the tank completely empty from time to time.

WETTABLE POWDERS:

Avoid use in piston pump sprayers models 425, 425-Deluxe, 425-HD, 425-L, 435, 425-PAF, 473-P! The Solo models 475-B, 475-Deluxe, 475-B Deluxe, 475-PAF, 473-D, 473-ECS, 478 and 485 sprayers with a diaphragm pump are generally resistant to abrasive materials and are recommended for this purpose. Note: If you use a wettable powder in your 425, 435 or 473-P sprayer, be sure that it is thoroughly mixed in the formula solution. Immediately after use, be sure to remove the piston and clean and lubricate the Viton® collar with Solo Superior Grease* or petroleum jelly. Thorough flushing of the sprayer will extend the life of its working parts. If you use wettable powders in the piston pump sprayer, be sure to inspect regularly for seepage around the piston, lubricate and/or repair accordingly.

CLEANING:

- After spraying, clean the tank thoroughly. If some spray liquid is left inside, drain tank completely.
- Pumping causes air to be taken in and the remaining liquid to be discharged. Pump until liquid and air are coming out through the nozzle.
- Refill tank with a few quarts of clean, soapy water and pump the water out as explained above (if necessary, repeat this procedure several times).
- If the shut-off valve is removed, the pump can be flushed quickly. Improper spray distribution is the result of a clogged nozzle, which is easily removed and cleaned.
- Soap and water may also be used to clean tank.
- Do not use aggressive cleaning agents or abrasives.
- Follow the recommendations of the chemical manufacturer for disposal of waste water and chemicals.
- Activated charcoal in liquid or other form may be used to absorb chemicals in tanks or spills.

NOTE: When cleaning the sprayer after working with hormone weedkillers, follow the instructions of the herbicide producers. Neutralize with activated charcoal. (Example: add 0.35 oz./1 g. of activated charcoal to 1.7 pint/1 liter of water and leave this detergent in the tank and the lines approximately for 24 hours.) This is very important if other chemicals will be sprayed as the residues of the herbicide may damage susceptible plants. Cleaning after application of products containing carbolineum is imperative. If the chemicals are not water soluble, cleaning should be done with a 5% soda lye having a temperature of 104°F (40°C). Rinse with plenty of clean water.

MAINTENANCE AND STORAGE TIPS:

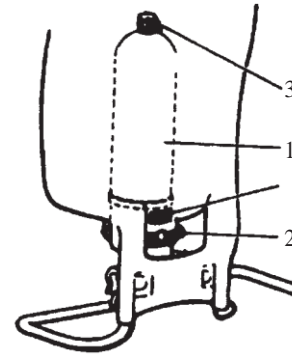

1. Pressure Cylinder
2. Cylinder Support Clamp
3. Pressure Control Valve (Deluxe Models Only)

- After operation, the sprayer should be stored away from direct sunlight to prevent UV damage.
- After removing the pump or when mounting a new Viton® collar, treat both the collar and the piston with water-resistant grease.*
- Before winter, drain all liquid in tank, lines and air chamber. (See "Cleaning.") **Leave shut-off valve locked in the "open" position to prevent freezing.**
- For service, visit our website to locate your nearest Solo dealer. Always insist on original Solo spare parts.
- Regularly inspect hose, wand, pump, tank and shut-off valve for wear, damage or leaks. Repair promptly.
- Occasionally lubricate cap gasket.*

Avoid excessive wear and prolong sprayer life by:

- 1) Regular lubrication of Viton® collar, cylinder and piston with water-resistant grease.*
- 2) Prompt and thorough cleaning and flushing of sprayer. Soap and water work well.

*Use Solo Superior Grease (#9850-P). Petroleum jelly may also be used.

SOLO LIMITED WARRANTY

Solo Incorporated guarantees the original purchaser of Solo equipment that any failure of Solo manufactured parts due to defects in material and workmanship, which occurs during the applicable warranty period, will be repaired or replaced without charge for parts or labor, except for those items not covered by warranty.

CONSUMER LIMITED WARRANTY: Solo equipment purchased for consumer use is covered by this Limited Warranty for a period of ONE (1) YEAR. Solo's polyethylene tank is covered by this limited warranty for the life of the unit.

COMMERCIAL LIMITED WARRANTY: Solo equipment purchased for commercial use is covered by this Limited Warranty for a period of ONE (1) YEAR.

OWNER'S OBLIGATION AND RESPONSIBILITY: Proof of purchase must be provided by the owner in order to obtain warranty service. Should any failure covered by this Limited Warranty occur, deliver or ship the Solo products or parts to an authorized Solo service center. Freight, packing and insurance costs, if any, will be borne by the owner. Follow normal maintenance service to include applicable lubrication, operation and storage of the product as explained in the operator's manual.

ITEMS NOT COVERED BY WARRANTY: Provisions of the Limited Warranty will not apply to the following: Any indirect or consequential damages that may result from the failure or malfunction of the Solo product. Normal service requirements arising during the warranty period, such as cleaning, normal wear, lubrication, filter, spray tips, etc. Normal service work over and above the repair or replacement of defective parts. Any failure that results from an accident, customer abuse, normal wear, neglect or failure to operate the product in accordance with the instructions provided in the operator's manual or provided with the product. When an alteration or modification has been performed on a Solo product, Solo is responsible only for products as originally furnished by Solo, provided the alterations or modifications do not adversely affect the product's operation, performance or durability. Parts or accessories that are incompatible with the product are not approved by Solo.

Full disclosure of Solo's Limited Warranty is available from your local Solo dealer or SOLO INCORPORATED, 5100 Chestnut Avenue, Newport News, Virginia 23605 (800-765-6462).

This Limited Warranty gives you specific legal rights and you may also have other rights, which vary from state to state.

ACCESSORIES:

The following accessories are not standard. An order form is provided on pages 11 and 12, or ask your Solo dealer.



Speed Tip Nozzle (#40 74 666): Change from a fine mist or jet stream or flat spray pattern with the twist of a dial.

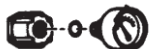

Pressure control gauge (#49 00 622): Displays spraying pressure so operator can maintain desired pressure level.



Brass adjustable spray nozzle (#06 10 410-P): Affords operator a full range of sprays from fine mist to jet stream. (Standard on models 425-Deluxe, 475-Deluxe, 425-PAF, 475-PAF and 478-SSH)



Drift guard (#49 00 430): Helps control application of formula under breezy conditions.



4-nozzle spray boom and mounting hardware (#49 00 298): Mounted on the back part of the sprayer frame with 4 hollow cone jets for area treatment (total width 49-3/4"; distance between nozzles 16").



2-nozzle spray boom (#49 00 514): Handheld spray boom mounts on end of spray wand (total width 33"; distance between nozzles 24"). Includes 2 flat spray nozzles.



Twin nozzle (#49 00 477): This is a multi-purpose nozzle that attaches to the end of the spray wand for double row application.



4' to 8' Carbon Fiber Wand (49 00 445) This lightweight spray wand adjusts from 4' to 8' and replaces the standard spray tube to reach eaves or trees up to 25 ft. (7.6 meters)



60" Brass spray wand (#49 00 528): The spray wand is 60" (150 cm) long and replaces the standard spray tube for treating trees up to heights of 16 ft. (5 meters). Additional extension tube available in 20" length (#49 00 513).



Deluxe Shoulder Saver Harness (#43 00 343): Heavy duty, fully adjustable, padded shoulder straps, large, padded lumbar support and fully adjustable chest strap.



Solo Superior Grease (#9850-P) (Not shown): (4 oz.) Used in the manufacture of Solo sprayers.

Controlled Flow Valve (CFValve™): Provides constant pressure and flow to the spray nozzle and can be used in various applications.

In the best interest of continued technological progress, we reserve the right to change design and configuration of any product without prior or other notice. Therefore, please note that text and illustrations of this manual are not to be considered binding and do not constitute a basis for legal or other claims.

SPARE PARTS LIST

Liste de pièces de rechange
Lista de piezas de recambio

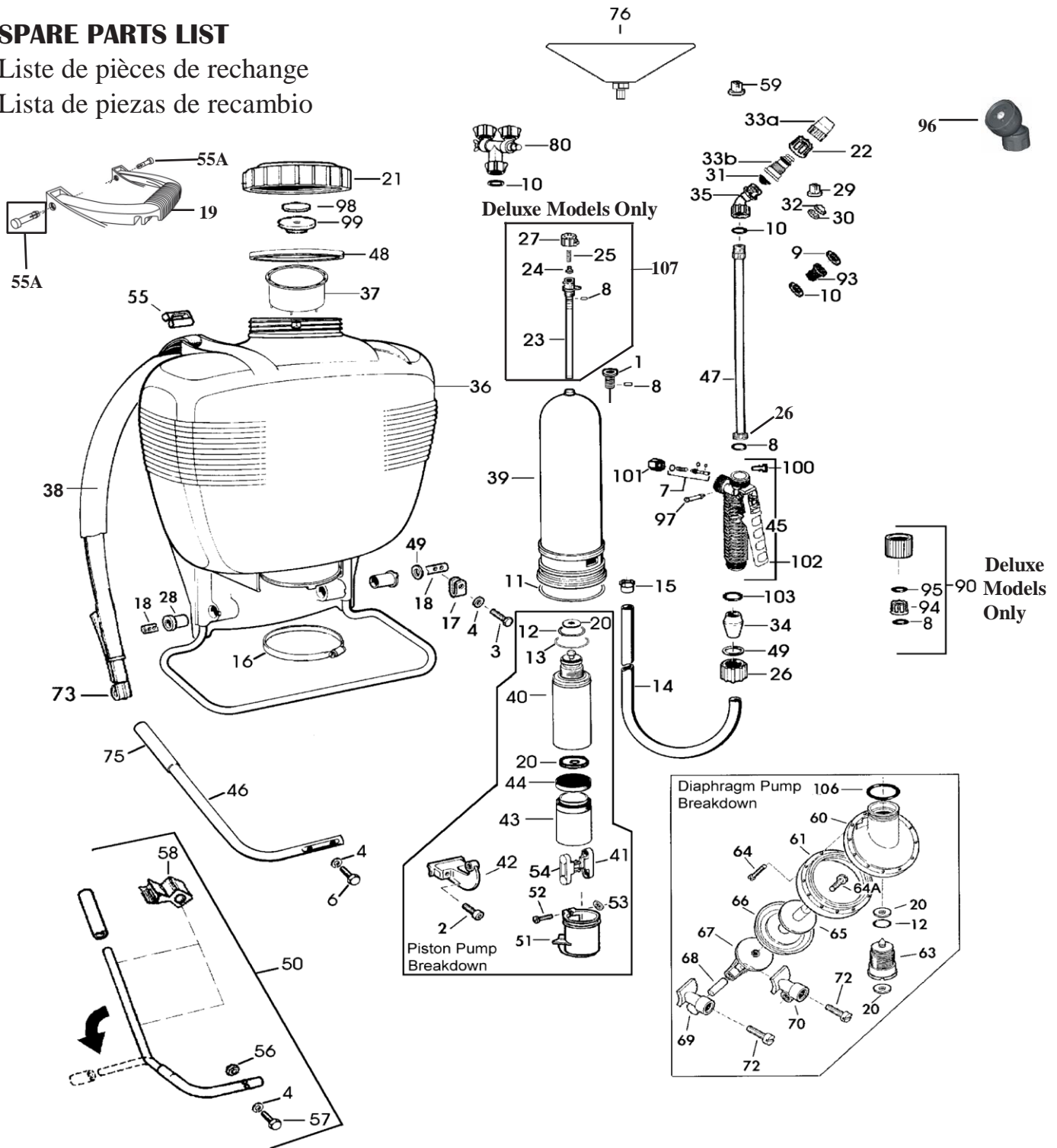

*Not standard on all models.

SPECIAL PARTS AND ACCESSORIES (Not shown in parts list)

Order No.	Description
4900310N	Conversion kit (from piston to diaphragm pump)
0610406-K	Diaphragm pump repair kit includes 8, 11, 12, 20 (2 ea.), 24, 25, 66, 106
0610407-K	Piston pump repair kit includes 8, 11-13, 20 (2 ea.), 24, 25, 44
	Wand repair kit includes 7, 8, 10, 22, 26, 34, 49, 103 0610409-K
	Piston, rod & collar kit includes 41-44, 54
4400203	Pump assembly (Piston) includes 8, 11, 12, 13, 20 (2 ea.), 39, 40, 41, 42, 43, 44, 54, 107
4400221	Pump assembly (Diaphragm) includes 8, 11, 12, 20 (2 ea.), 39, 61, 63, 64 (12 ea.), 64A, 65, 66, 67, 106, 107

POS. #	ORDER #	FOR MOD.	DESCRIPTION	FRANCAIS	ESPAÑOL
2	00 10 165		Bolt	Vis T.C.	Tornillo cil.
3	00 12 185		Bolt **	Vis T.C.	Tornillo cil.
4	00 30 131		Washer **	Rondelle	Arandela
6	00 12 185		Bolt	Vis T.C.	Tornillo cil.
8	00 62 258		Gasket	Joint de connection	Junta de conexion
10	00 62 115		O-ring	Joint bague	Anillo O
11	00 62 291		O-ring	Joint bague	Anillo R
12	00 62 139		O-ring	Joint bague	Anillo R
13	00 62 140		O-ring	Joint bague	Anillo R
14	00 64 234		Hose 48" (item 26, 34, 49, 103 incl.)	Tuyau (Pos. 26, 34, 49, 103 incl.)	Manguera (artículo 26, 34, 49, 103 incl.)
15	00 66 388		Hose clamp	Collier cpl.	Abrazadera
16	00 66 394		Clamp	Collier cpl.	Abrazadera
17	40 43 123		Stop plate **	Butée	Pieza de apoyo
18	40 35 111		Pump shaft	Tuyau	tubo
20	40 61 257		Valve plate	Joint de soupape	Placa de valvula
21	42 00 242		Red tank cap (item 48, 98 & 99 incl.)	Couvercle	Tapa del depósito (roja)
—	42 00 305		Black tank cap (item 48, 98 & 99 incl.)	Couvercle	Tapa del depósito (negra)
22	40 74 148	Heavy Duty	Retaining nut	Ecrou de raccord	Tuerca de manguito
23	40 74 323		Valve body	Pièce de réglage	Pieza de ajuste
24	40 74 350		Sealing plug	Joint	Junta
25	00 70 260		Compression spring	Ressort de compression	Resorte de presion
26	40 74 337		Retaining nut	Ecrou de raccord	Tuerca de manguito
27	40 74 344		Control knob	Pièce de réglage	Tapa de ajuste
28	40 74 410		Bushing	Coussinet	Cohinete
29	40 74 263		Flat spray jet	Buse à diffusion large	Tobera de chorro ancho
30	40 74 756		Swirl plate	Pièce girafoire	Pieza de rayado
31	40 74 283		Jet filter	tamis de gicleur	Piltro de tobera
32	40 74 755		Jet cap	Capuchon de gicleur	Tapa de tobera
33	49 00 527		Plastic adjustable nozzle (Inc. a & b)	Buse réglable en plastique	Boquilla ajustable
—	49 00 207		Brass Adj. spray nozzle	Bouchier	Boquilla ajustable
34	40 74 500		Clamp	Pièce de serrage	Pieza de retencion
35	40 74 527		Elbow	Coude	Code
36	42 00 162	425, 475, 478	Tank and frame assy., 4 gal.	Support de réservoir, 15l	Soporte de depósito, 15l
—	42 00 293	435,485	Tank and frame assy., 5 gal.	Support de réservoir, 20l	Soporte de depósito, 20l
—	40 71 305	473P, 473D	Tank and frame assy., 3 gal.	Entonnoir	Embudo Filtro
37	42 00 166		Filter basket	Le panier-filtre	Filtro de canasta
38	43 00 315	Deluxe Models	Shoulder strap (item 73 incl.)	Bretelle (Pos. 73 incl.)	Correa (artículo 73 incl.)
38	43 00 340		Deluxe Shoulder Strap (Item 73 incl.)	Bretelle de luxe (Pos. 73 incl.)	Correa de lujo (artículo 73 incl.)
39	44 00 240		Pressure cylinder (Deluxe Models)	Cylindre cpl.	Cilindro mont
40	4400240N		Pressure cylinder		
40	40 73 190		Cylinder, assy. (item 12, 13, 20 incl.)	Bielle sand tétou	Biela
41	40 74 409		Connecting rod without stud	Levier	Palanca
42	40 74 262		Lever	Piston	Piston
43	40 73 558		Piston	Manchette Viton	Manguito Viton
44	44 00 189		Viton® collar	Robinet d'arrêt	Grifo de cierre, mont.
45	48 00 170	475-B, 475-B Deluxe	Shut-off valve, assy.	Levier de pompe (pos. 75 incl.)	Palanca de bomba (artículo 75 incl.)
45	48 00 249		Shut-off valve, assy. (Bleach Resistant)	Levier de pompe (pos. 75 incl.)	Palanca de bomba (artículo 75 incl.)
46	48 00 17325		Pump lever (item 75 incl.)	Tuyau pulvérisateur (500 mm)	Tubo atomizador (500 mm)
47	49 00 230		Spray tube 20" (item 8, 26 incl.)	Joint bague (pos. 8, 26 incl.)	Anillio de junta (artículo 8, 26 included)
—	49 00 645		Stainless Wand		
48	4900421		Brass Wand		
48	40 61 345		Gasket	Rondelle	Arandela
49	00 31 356		Washer	Coiffe protectrice	Tapa protectora
51	40 74 680		Protective cover	vis T.C.	Tronillo cil.
52	00 10 110		Bolt	Ecrou. hex.	Tuerca hex.
53	00 20 101		Hex. nut	Bielle avec teton	Biela
54	40 74 408		Connecting rod with stud	Porte-bretelle	Hebilla para correa
55	40 74 412		Strap Buckle (Pre 2013 Models)	Carter de membrane	Carter membrana
55A	40 74 425		Strap Pin (2013 and later Models)	Chaveta	Goujon
58	40 74 996		Wand retainer clip	Retenue de la lance	
60	40 73 411		Housing (diaphragm)	Joint bague	Anillo O
61	40 73 410		Flange	Siège soupape (pos. 12, 20 incl.)	Pieza rosada (artículo 12, 20 incl.)
63	44 00 222		Valve, assy. (item 12, 20 incl.)	Vis T.C.	Tornillo cil.
64	00 18 275		Screw	Plaque à membrane	Chapa de membrana
64A	00 18 275		Diaphragm screw	Vis de diaphragme	Tornillo de la diafragma
65	40 74 256		Plunger	Membrane	Membrana
66	40 74 246	475-B, 475-B Deluxe	Diaphragm (Bleach Resistant)	Bielle (Cloro resistente)	Biela (Resistente au chlore)
67	40 74 255		Lever	Goujon	Perno
68	40 31 130		Wrist pin	Levier 1	Palanca 1
69	40 74 243		"L" connecting bracket	Levier 2	Palanca 2
70	40 74 234		"R" connecting bracket	Vis T.C.	Tornillo cil.
72	00 10 141		Bolt	Accroche	Gancho
73	40 74 835		Hook	Crochet	Gancho
75	40 74 392		Grip	Poignée	Apretón
97	40 74 295		Pin	Goupille	Perno
98	40 61 464		Vent plate	Plaque de décompression	Placa de la respiradora
99	40 74 123		Vent cap	Capuchon de décompression	Tapa de la respiradora
100	40 74 329		Lock clip	Pince de verrouillage	Sujetador de cerradura
101	40 74 336		Retaining nut	Écrou de serrage	Tuerca de retención
102	40 74 335		Lever	Levier	Palanca
103	00 62 271		O-ring	Joint torique	Anillo-O
106	00 62 324		O-ring	Joint torique	Anillo-O
107	48 00 182		Pressure Control Valve(item 8,23,24,25,27)	Régulateur de Pression	Valvula de Control
**	**		Diaphragm Pump Sprayer Only		

ACCESSORIES

1	42 00 215		Plug (item 8 incl.)	Bouchon (pos. 8 incl.)	Tapón (artículo 8 incl.)
7	06 10 402-K 49 00 319		Shut-off valve repair kit Spray wand 27" (690 mm) (item 8, 26 incl.)	Pochette robinet d'arrêt Lance de vaporisation de 69 cm (27 po) 18, 26 incl.)	Juego rep. grifo de cierre\ Vara de pulverizador 27" (690mm) (art. 8 26 incl.)
19	40 73 725		Carrying Handle (Requires 2 x 4074425)	Asa de transporte	Poignée de transport
50	49 00 454		Fold-away handle (item 4, 56, 57, 58 incl.)	Poignée rabattable (réf. 4, 56, 57, 58 compr.)	Manilla plegue (artículo 4, 56, 57, 58 incl.)
56	00 20 119		Nut	Écrou	Tuerca
57	00 12 192		Bolt	Boulon	Cerjojo
58	40 74 996		Clip	Pince	Sujetador
59	00 65 210	Heavy Duty	Brass flat spray nozzle	Buse à jet platen laiton	Boquilla de pulverizador de latón plano
76	49 00 430		Drift guard	Anti-dérive	Protector de la deriva
80	49 00 477		Double spray nozzle	Buse à double jet	Boquilla doble de pulverizador
—	49 00 528		Extension wand 60" (1250 mm)	Rallonge de lance de 1,25m (60 po)	Vara de extensión (1250 mm)
90	49 00 622		Pressure gauge w/connection parts		Mandometro
—	49 00 513		Extension tube 20" (500 mm)		Tuba alargador (500 mm)
93	27 00 316	Heavy Duty	Nodrip check valve	Clapet anti-retour	Valvula de retencion
94	40 74 338		Retaining nut		Tuerca de manguito
95	00 62 249		O-ring	Joint torique	Anillo O
96	40 74 666		Speed Tip Nozzle		
—	06 10 410-P		Brass Adj. spray nozzle assy.	Joit bague	Tobera de allura, mont.
—	43 00 343		Deluxe Shoulder saver harness	Buse longue protee, cpl.	
—	42 00 205		Reduction insert, gaskets incl.	Reducreur avec jñts	Empaquetaduras
—	49 00 258N		Elbow nozzle assy. (item 10, 22, 31, 33, 35 incl.)	Pochette joints (10, 22, 31, 33, 35 incl.)	Juego empaquetaduras 8 (10, 22, 31, 33, 35 incl.)

INSTALLATION INSTRUCTIONS

PISTON PUMP REPAIR KIT (# 0610407-K)

Tools needed for kit installation: 6mm Allen Head Wrench, Flat Screwdriver, 11mm Wrench or Crescent Wrench, Long Nose Pliers, Hammer, 13mm Socket or Wrench, T-25 Torx Screwdriver, Grease or Petroleum Jelly, 2X4 Piece of wood 18" long

1. Using a 13mm socket wrench remove the handle bolts, and set aside. Lay unit on its back with pump assembly facing you. See figure 1. Loosen hose clamp (E). Pull off sprayer hose. Caution: There may be liquid inside the hose and pressure cylinder even when the tank is empty. Wear protective gloves. Next, remove the nut and bolt from protective cap, and remove cap (C). Rotate the pump shaft to access the two lever bolts in the center (B). Using a 6mm allen head wrench, remove them. Pull the piston (F) out of the piston cylinder (D).

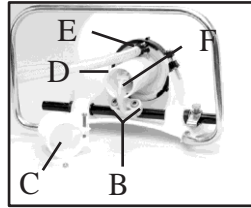

Figure 1.

2. To remove the piston cylinder assembly, turn the cylinder counter clockwise when viewing from the bottom. Figure 2. Caution: The piston cylinder has sharp edges.



Figure 2.

3. Check the outside of the piston and inside of the cylinder for scratches. If the piston or cylinder are scratched, replace with part# 0610409-K (piston) or part# 4073190 (cylinder). Figure 3.

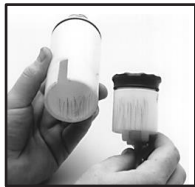

Figure 3.

4. To replace the Viton® collar, push it off the top of the piston with your thumb. Figure 4. Install the new collar on the piston onto the form fitted sides.



Figure 4.

5. Remove the valve plate and O-rings from the outside of the piston cylinder. Install the new valve plate and the two O-rings making sure the O-rings seat in the grooves. Finally, inside the piston cylinder you will find a second valve plate. Using needle nose pliers, pull out the red or orange pin and remove the valve plate. Figure 5.



Figure 5.

6. Install a new valve plate and firmly reseat the retaining pin using needle nose pliers. Figure 6.



Figure 6.

7. If the sprayer was leaking at the pressure cylinder, it may be necessary to remove the pressure cylinder. First, unscrew the pressure regulator control, if equipped. Remove the large clamp at the bottom of the cylinder. Using a block of wood and a large hammer, forcefully hit the top of the pressure cylinder, driving the assembly through the bottom of the tank. Figure 7. Replace and lubricate the O-ring at the bottom of the pressure cylinder, then reinstall the pressure cylinder using the block of wood and hammer. Reattach clamp.



Figure 7.

8. Next, assemble the piston cylinder. First, lubricate the O-rings on the piston cylinder, being careful not to get any on the valve plate. Screw the piston cylinder clockwise into the pressure cylinder until it is tight and the bottom O-ring is no longer seen. Figure 8. When properly seated the notch on the piston cylinder (G) will line up with the indent on the pressure cylinder (H). Figure 9.

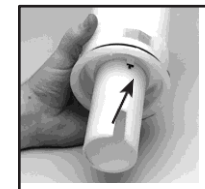

Figure 8.

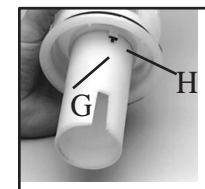

Figure 9.

9. Apply a light coat of grease to the inside of the piston cylinder wall and on the Viton® collar, and then re-install the piston into the piston cylinder. Figure 10. To insert the piston, tilt at a slight angle with the leading edge of the Viton® collar placed over the slot. When seated, install the 6mm Allen Head bolts through lever base into shaft. Replace the protective cap and tighten the nut and bolt. Reinstall the handle. Replace the hose and black hose clamp making sure it is firmly secured.



Figure 10.

Note: Always wear rubber gloves, safety goggles and appropriate protective clothing when repairing a sprayer. Work in a well-ventilated area. Prior to repair, flush unit with water by filling, then spraying the water into an appropriate container or area. Ensure that all pressure is released by locking the shut-off valve in the open position. Once a repair is completed, fill the unit with clean water, pressurize, and check for leaks. If the sprayer leaks, DO NOT USE. Repair leaks and recheck.

INSTALLATION INSTRUCTIONS

Diaphragm Pump Repair Kit (# 0610406-K)

Tools needed for kit installation: 6mm Allen Head Wrench, Flat Screwdriver, 11mm Wrench or Crescent Wrench, Long Nose Pliers, Hammer, 13mm Socket or Wrench, T-25 Torx Screwdriver, Grease or Petroleum Jelly, 2X4 Piece of wood 18" long

1. Using a 13mm socket wrench, remove handle bolts and loosen the stop plate (A) and remove the two allen head screws (B) that hold the connecting pieces to the pump rod. Figure 1.

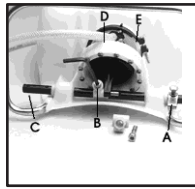

Figure 1.

2. With unit laying on its back with pump assembly facing you, remove the pump rod (C). Loosen hose clamp and remove pressure hose (D). Caution: There may be liquid inside the hose and pressure cylinder even when the tank is empty. Wear protective gloves. Next, loosen the clamp at the base of the sprayer (E). Figure 2.

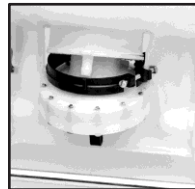

Figure 2.

3. Push the pressure cylinder approximately 1/2" out of the bottom of the tank. Then turn the pump assy. 180 degrees. Note: Wooden block may be used to tap the pump assembly through bottom of tank. Remove pressure regulating valve, if equipped before removal of cylinder. Figure 3.

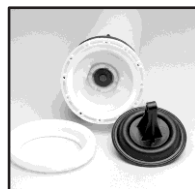

Figure 3.

4. Next remove the 12 torx screws that hold the flange in place. The flange and diaphragm can then be removed. Figure 3. Note: For clarity the pressure cylinder is shown removed from the tank. Figure 4.

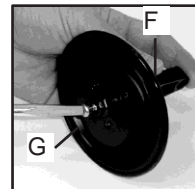

Figure 4.

5. To replace the diaphragm, remove the connecting rod retaining screw (G) from the plunger and lever (F). Replace the diaphragm and reassemble. See Figure 4. Figure 5.

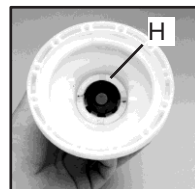

Figure 5.

6. The valve assy. (H) is removed using a locally made tool. Remove red valve plate retaining pin using needle nose pliers, then insert tool into slots. See Figure 5. Use a screwdriver to rotate tool counter clockwise. Figure 6.

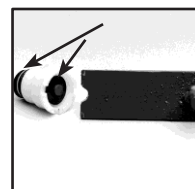

Figure 6.

7. The valve plates and O-rings can now be replaced. The bottom valve plate is secured into place with the red retaining pin. Push pin into place using needle nose pliers. Figure 6. Figure 7.

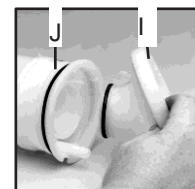

Figure 7.

9. When reassembling the pump housing to the pressure cylinder, be sure the square tab on the pump housing (K) is aligned in the notch. See arrows (L) on the pressure cylinder in Figure 8. Be careful not to pinch or nick the O-ring. Figure 8.

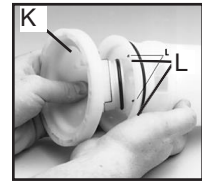

Figure 8.

Note: Grease O-rings for re-assembly. Screw the valve assembly into the cylinder.

10. Place diaphragm assembly (O) onto the pump housing (M). Place the flange (N) over the diaphragm. Reinstall the 12 torx screws around the outside diameter of the flange. Figure 9.

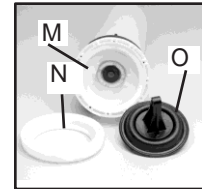

Figure 9.

11. Lubricate the large O-ring and then push the pressure cylinder into the tank being careful not to pinch the large O-ring (P). Note: Wooden block may also be used for installation of the pressure cylinder. Figure 10.

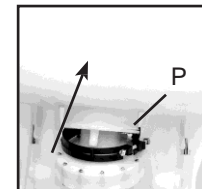

Figure 10.

12. Tighten pump clamp securely (E). Install pump rod (C). Reinstall the connecting pieces and allen head screws (B). Reinstall the stop plate (A) making sure that the bolt goes through the rear hole. Reinstall the hose and hose clamp making sure it is firmly secured (D). Figure 11.

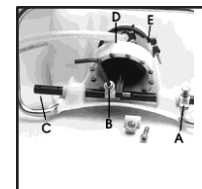
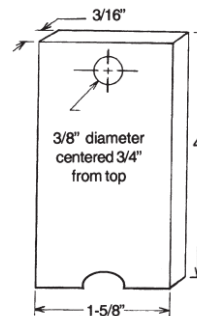
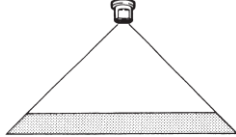
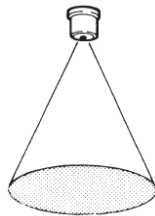
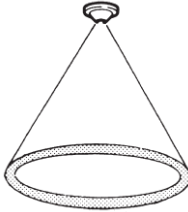
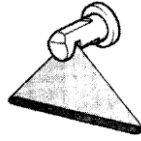



Figure 11.



Note: Always wear rubber gloves, safety goggles and appropriate protective clothing when repairing a sprayer. Work in a well ventilated area. Prior to repair, flush unit with water by filling, then spraying the water into an appropriate container or area. Ensure that all pressure is released by locking the shut-off valve in the open position. Once a repair is completed, fill the unit with clean water, pressurize, and check for leaks. If the sprayer leaks, DO NOT USE. Repair leaks and recheck.

Nozzle Tip Specifications

Description	Order number	Spray volume		Pressure		Angle	Applications
		1/min	US gal /min	atu atm	psi		
Flat spray nozzle	4074263*	0.88 1.25 1.53	.23 .33 .40	1.0 2.0 3.0	15 29 44	120° 120° 120°	area and row treatment 
Flat spray nozzle - brass - plastic with stainless steel insert	0065210 0065132	0.46 0.64 0.78	.12 .17 .21	1.0 2.0 3.0	15 29 44	80° 80° 80°	
Adjustable nozzle - brass - plastic	4900207 4900527*	1.53 0.76	.40 .20	2.8 2.8	40 40	Straight stream Hollow cone	tree spraying (adjustable spraying pattern)
Full cone nozzle	0065212					30°-50°	game repellants of high viscosity
Full cone nozzle	0065213					30°-50°	game repellants of low viscosity
Full cone nozzle	0065214						game repellants
Hollow cone nozzle 1 mm orifice	4900209	0.4 0.55	.10 .15	1.0 2.0	15 29		shrubs, bushes 
Hollow cone nozzle 1.4 mm orifice	4900252	0.64 0.91 1.11	.17 .24 .29	1.0 2.0 3.0	15 29 44	50° 65° 65°	
Hollow cone nozzle 1.8 mm orifice	4900322*	0.88 1.25 1.53	.23 .33 .40	1.0 2.0 3.0	15 29 44	55° 70° 72°	
No-drift nozzle AN 0.5	4074383	0.23	.06	1.0	15	90°	
No-drift nozzle AN 1.0	4074385	0.28 0.38 0.46	.07 .10 .12	0.4 0.7 1.0	6 10 15	100° 100° 100°	mainly for herbicides at low pressure 
No-drift nozzle AN 2.0	4074386	0.55 0.76 0.91	.15 .20 .24	0.4 0.7 1.0	6 10 15	100° 100° 100°	
No-drift nozzle AN 2.5	4074514	0.72 0.95 1.14	.19 .25 .30	0.4 0.7 1.0	6 10 15	110° 110° 110°	
No-drift nozzle AN 5.0	4074513	1.80 1.90 2.28	.48 .50 .60	0.4 0.7 1.0	6 10 15	120° 120° 120°	
Foam nozzle	4900397	0.76 0.90 1.01 1.10	.20 .23 .26 .29	3.0 4.0 5.0 6.0	45 60 75 90		

*Standard equipment

solo[®] ORDER FORM

Order parts and accessories online at www.solousa.com or from your Solo dealer. If there is no local Solo dealer, use this form to order

Item Names/Description	Part No.	Retail Price	Qty.	Total
<u>Nozzles</u>				
Flat spray nozzle - surface area & row treatment	40 74 263	2.00		
Jet cap	40 74 755	1.50		
Swirl plate	40 74 756	1.50		
Filter - standard	40 74 283	2.55		
Sprayer elbow and nozzle assortment	06 10 408-P	14.95		
No-drift wide angle flat nozzles - .60 GPM	40 74 513	2.50		
mainly for spraying herbicides at low pressure. .30 GPM	40 74 514	2.50		
At 15 psi they deliver: .24 GPM	40 74 386	2.50		
.12 GPM	40 74 385	2.50		
Elbow nozzle assembly	49 00 258N	6.35		
Double spray nozzle - for double row application spraying in two directions simultaneously.	49 00 477	29.95		
Brass adjustable spray nozzle kit - with jet filter and screw cap for tree spraying (from fine misting to a jet stream).	06 10 410-P	8.75		
Brass adjustable spray nozzle (same nozzle as kit above)	49 00 207	6.25		
Plastic adjustable nozzle	49 00 527	4.25		
Hollow cone nozzles - for shrubs & bushes: 1.4 mm	49 00 252	2.85		
1.8 mm	49 00 322	2.85		
Foam spray nozzle - for low drift & water saving application of herbicides which tend to foam.	49 00 397	14.95		
No drip check valve - prevents spray tip from leaking when not in use.	27 00 316	4.95		
Speed Tip Nozzle - Change from a fine mist, or a jet stream or a flat spray pattern with the twist of a dial.	4074666	8.95		
Nozzle assortment - includes flat, hollow cone, no drift, and plastic adjustable nozzles.	06 10 456-P	12.95		
<u>Extension tubes and spray wands</u>				
20" spray wand	49 00 230	9.95		
20" extension tube	49 00 513	16.95		
21" stainless steel wand	49 00 645-P	11.95		
20" brass spray wand	49 00 421	12.95		
27" spray wand	49 00 319	13.95		
40" brass telescoping wand	49 00 478	34.95		
48" carbon fiber wand	49 00 449	39.95		
60" brass spray wand	49 00 528	34.95		
4' to 8' Carbon Fiber Wand	49 00 445	79.95		
Note: extension tubes attach to wands to extend length. Spray wands attach to shut-off valve only.				
<u>Spray booms</u>				
Spray booms - spray 2 or 4 rows at once with:				
2-nozzle spray boom - handheld (total width 33") distance between nozzles 24". Includes 2 flat spray nozzles.	49 00 514	34.95		
4-nozzle spray boom - mounts on rear of sprayer (total width 49 3/4"; distance between nozzles 16"). Includes 4 hollow cone nozzles.	49 00 298	99.90		
<u>Specialty items</u>				
Shoulder Saver Harness - padded shoulder straps and padded lumbar support reduces lower back fatigue. Fits all models.	43 00 343	29.95		
Pressure gauge kits - indicates spray pressure. Use with shut-off valve 4800170. Fits all models.	49 00 622	29.95		
Drift guard - complete control for herbicide applications in berry, flower, vegetable, cotton & other applications.	49 00 430	16.95		

