

**Processes**



MIG (GMAW) Welding



Flux Cored (FCAW) Welding

**Description**



Arc Welding Power Source And  
Wire Feeder

# Handler<sup>®</sup> 210 MVP And H100S4-10 Gun

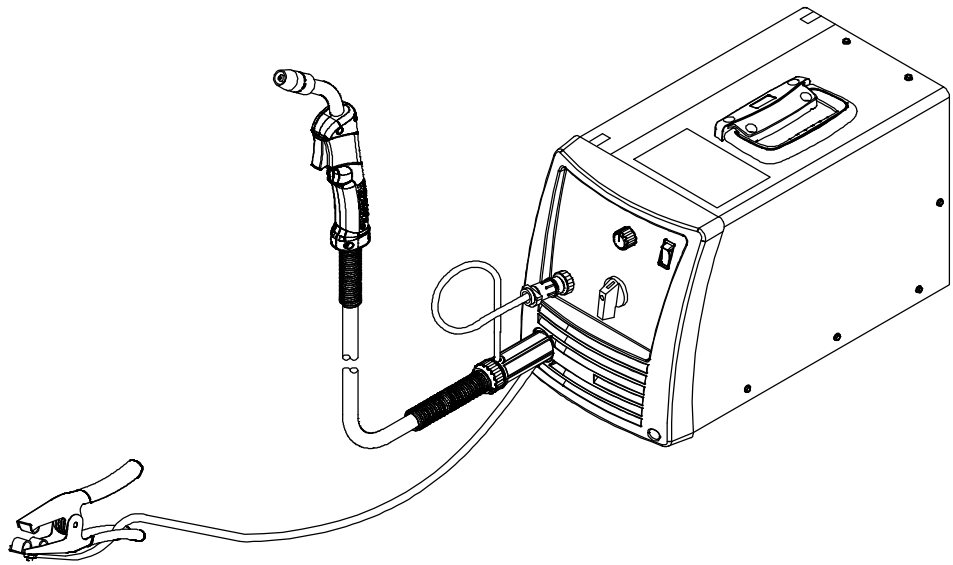

## OWNER'S MANUAL



# TABLE OF CONTENTS

<b>SECTION 1 – SAFETY PRECAUTIONS - READ BEFORE USING</b> .....	<b>1</b>
1-1. Symbol Usage .....	1
1-2. Arc Welding Hazards .....	1
1-3. Additional Symbols For Installation, Operation, And Maintenance .....	3
1-4. California Proposition 65 Warnings .....	4
1-5. Principal Safety Standards .....	4
1-6. EMF Information .....	4
<b>SECTION 2 – CONSIGNES DE SÉCURITÉ – LIRE AVANT UTILISATION</b> .....	<b>5</b>
2-1. Symboles utilisés .....	5
2-2. Dangers relatifs au soudage à l'arc .....	5
2-3. Dangers supplémentaires en relation avec l'installation, le fonctionnement et la maintenance .....	7
2-4. Proposition californienne 65 Avertissements .....	8
2-5. Principales normes de sécurité .....	8
2-6. Informations relatives aux CEM .....	8
<b>SECTION 3 – DEFINITIONS</b> .....	<b>9</b>
3-1. Additional Safety Symbols And Definitions .....	9
3-2. Miscellaneous Symbols And Definitions .....	9
<b>SECTION 4 – SPECIFICATIONS</b> .....	<b>10</b>
4-1. Serial Number And Rating Label Location .....	10
4-2. Unit Specifications For 230 VAC .....	10
4-3. Unit Specifications For 115 VAC .....	10
4-4. Duty Cycle And Overheating .....	11
4-5. Volt-Ampere Curves .....	12
<b>SECTION 5 – INSTALLATION</b> .....	<b>13</b>
5-1. Selecting A Location .....	13
5-2. Installing Nozzle, Contact Tip, And Adapter .....	13
5-3. Installing Work Clamp .....	13
5-4. Installing Welding Gun .....	14
5-5. Process/Polarity Table .....	14
5-6. Changing Polarity .....	14
5-7. Installing Gas Supply .....	15
5-8. Electrical Service Guide .....	16
5-9. Extension Cord Data (Use Shortest Cord Possible) .....	16
5-10. Multi-Voltage Plug (MVP) Connection .....	17
5-11. Connecting Input Power .....	18
5-12. Connecting 1-Phase Input Power For 230 VAC Input .....	19
5-13. Connecting 1-Phase Input Power For 115 VAC Input .....	20
5-14. Installing Wire Spool And Adjusting Hub Tension .....	20
5-15. Connecting Optional Spool Gun .....	21
5-16. Threading Welding Wire .....	22
<b>SECTION 6 – OPERATION</b> .....	<b>23</b>
6-1. Controls .....	23
6-2. Weld Parameter Chart .....	24
<b>SECTION 7 – MAINTENANCE &amp; TROUBLESHOOTING</b> .....	<b>25</b>
7-1. Routine Maintenance .....	25
7-2. Overload Protection .....	25
7-3. Drive Motor Protection .....	26
7-4. Changing Drive Roll Or Wire Inlet Guide .....	26
7-5. Changing Nozzle, Contact Tip, Adapter And Liner, And Cleaning Gun Casing .....	27
7-6. Replacing Switch And/Or Head Tube .....	28
7-7. Troubleshooting Table .....	29
<b>SECTION 8 – ELECTRICAL DIAGRAM</b> .....	<b>30</b>
<b>SECTION 9 – GMAW WELDING (MIG) GUIDELINES</b> .....	<b>31</b>
<b>SECTION 10 – ACCESSORIES/CONSUMABLES</b> .....	<b>39</b>
<b>COMPLETE PARTS LIST – Available at <a href="http://www.HobartWelders.com">www.HobartWelders.com</a></b>	
<b>WARRANTY</b>	



ISO 9001  
Quality

Hobart is registered to  
the ISO 9001 Quality  
System Standard.



# SECTION 1 – SAFETY PRECAUTIONS - READ BEFORE USING

som 2018-01

**⚠** Protect yourself and others from injury — read, follow, and save these important safety precautions and operating instructions.

## 1-1. Symbol Usage



**DANGER!** – Indicates a hazardous situation which, if not avoided, will result in death or serious injury. The possible hazards are shown in the adjoining symbols or explained in the text.



Indicates a hazardous situation which, if not avoided, could result in death or serious injury. The possible hazards are shown in the adjoining symbols or explained in the text.

**NOTICE** – Indicates statements not related to personal injury.

 Indicates special instructions.



This group of symbols means Warning! Watch Out! ELECTRIC SHOCK, MOVING PARTS, and HOT PARTS hazards. Consult symbols and related instructions below for necessary actions to avoid the hazards.

## 1-2. Arc Welding Hazards



The symbols shown below are used throughout this manual to call attention to and identify possible hazards. When you see the symbol, watch out, and follow the related instructions to avoid the hazard. The safety information given below is only a summary of the more complete safety information found in the Safety Standards listed in Section 1-5. Read and follow all Safety Standards.



Only qualified persons should install, operate, maintain, and repair this equipment. A qualified person is defined as one who, by possession of a recognized degree, certificate, or professional standing, or who by extensive knowledge, training and experience, has successfully demonstrated ability to solve or resolve problems relating to the subject matter, the work, or the project and has received safety training to recognize and avoid the hazards involved.



During operation, keep everybody, especially children, away.



### ELECTRIC SHOCK can kill.

Touching live electrical parts can cause fatal shocks or severe burns. The electrode and work circuit is electrically live whenever the output is on. The input power circuit and machine internal circuits are also live when power is on. In semiautomatic or automatic wire welding, the wire, wire reel, drive roll housing, and all metal parts touching the welding wire are electrically live. Incorrectly installed or improperly grounded equipment is a hazard.

- Do not touch live electrical parts.

- Wear dry, hole-free insulating gloves and body protection.
- Insulate yourself from work and ground using dry insulating mats or covers big enough to prevent any physical contact with the work or ground.
- Do not use AC weld output in damp, wet, or confined spaces, or if there is a danger of falling.
- Use AC output ONLY if required for the welding process.
- If AC output is required, use remote output control if present on unit.
- Additional safety precautions are required when any of the following electrically hazardous conditions are present: in damp locations or while wearing wet clothing; on metal structures such as floors, gratings, or scaffolds; when in cramped positions such as sitting, kneeling, or lying; or when there is a high risk of unavoidable or accidental contact with the workpiece or ground. For these conditions, use the following equipment in order presented: 1) a semiautomatic DC constant voltage (wire) welder, 2) a DC manual (stick) welder, or 3) an AC welder with reduced open-circuit voltage. In most situations, use of a DC, constant voltage wire welder is recommended. And, do not work alone!
- Disconnect input power or stop engine before installing or servicing this equipment. Lockout/tagout input power according to OSHA 29 CFR 1910.147 (see Safety Standards).

- Properly install, ground, and operate this equipment according to its Owner's Manual and national, state, and local codes.
- Always verify the supply ground – check and be sure that input power cord ground wire is properly connected to ground terminal in disconnect box or that cord plug is connected to a properly grounded receptacle outlet.
- When making input connections, attach proper grounding conductor first – double-check connections.
- Keep cords dry, free of oil and grease, and protected from hot metal and sparks.
- Frequently inspect input power cord and ground conductor for damage or bare wiring – replace immediately if damaged – bare wiring can kill.
- Turn off all equipment when not in use.
- Do not use worn, damaged, undersized, or repaired cables.
- Do not drape cables over your body.
- If earth grounding of the workpiece is required, ground it directly with a separate cable.
- Do not touch electrode if you are in contact with the work, ground, or another electrode from a different machine.
- Do not touch electrode holders connected to two welding machines at the same time since double open-circuit voltage will be present.
- Use only well-maintained equipment. Repair or replace damaged parts at once. Maintain unit according to manual.
- Wear a safety harness if working above floor level.
- Keep all panels and covers securely in place.
- Clamp work cable with good metal-to-metal contact to workpiece or worktable as near the weld as practical.
- Insulate work clamp when not connected to workpiece to prevent contact with any metal object.
- Do not connect more than one electrode or work cable to any single weld output terminal. Disconnect cable for process not in use.
- Use GFCI protection when operating auxiliary equipment in damp or wet locations.

### SIGNIFICANT DC VOLTAGE exists in inverter welding power sources AFTER removal of input power.

- Turn off unit, disconnect input power, and discharge input capacitors according to instructions in Manual before touching any parts.



### HOT PARTS can burn.

- Do not touch hot parts bare handed.
- Allow cooling period before working on equipment.
- To handle hot parts, use proper tools and/or wear heavy, insulated welding gloves and clothing to prevent burns.



### FUMES AND GASES can be hazardous.

Welding produces fumes and gases. Breathing these fumes and gases can be hazardous to your health.

- Keep your head out of the fumes. Do not breathe the fumes.
- Ventilate the work area and/or use local forced ventilation at the arc to remove welding fumes and gases. The recommended way to determine adequate ventilation is to sample for the composition and quantity of fumes and gases to which personnel are exposed.
- If ventilation is poor, wear an approved air-supplied respirator.
- Read and understand the Safety Data Sheets (SDSs) and the manufacturer's instructions for adhesives, coatings, cleaners, consumables, coolants, degreasers, fluxes, and metals.
- Work in a confined space only if it is well ventilated, or while wearing an air-supplied respirator. Always have a trained watchperson nearby. Welding fumes and gases can displace air and lower the oxygen level causing injury or death. Be sure the breathing air is safe.
- Do not weld in locations near degreasing, cleaning, or spraying operations. The heat and rays of the arc can react with vapors to form highly toxic and irritating gases.
- Do not weld on coated metals, such as galvanized, lead, or cadmium plated steel, unless the coating is removed from the weld area, the area is well ventilated, and while wearing an air-supplied respirator. The coatings and any metals containing these elements can give off toxic fumes if welded.



### ARC RAYS can burn eyes and skin.

Arc rays from the welding process produce intense visible and invisible (ultraviolet and infrared) rays that can burn eyes and skin. Sparks fly off from the weld.

- Wear an approved welding helmet fitted with a proper shade of filter lenses to protect your face and eyes from arc rays and sparks when welding or watching (see ANSI Z49.1 and Z87.1 listed in Safety Standards).
- Wear approved safety glasses with side shields under your helmet.
- Use protective screens or barriers to protect others from flash, glare and sparks; warn others not to watch the arc.
- Wear body protection made from durable, flame-resistant material (leather, heavy cotton, wool). Body protection includes oil-free clothing such as leather gloves, heavy shirt, cuffless trousers, high shoes, and a cap.



### WELDING can cause fire or explosion.

Welding on closed containers, such as tanks, drums, or pipes, can cause them to blow up. Sparks can fly off from the welding arc. The flying sparks, hot workpiece, and hot equipment can cause fires and burns. Accidental contact of electrode to metal objects can cause sparks, explosion, overheating, or fire. Check and be sure the area is safe before doing any welding.

- Remove all flammables within 35 ft (10.7 m) of the welding arc. If this is not possible, tightly cover them with approved covers.
- Do not weld where flying sparks can strike flammable material.
- Protect yourself and others from flying sparks and hot metal.
- Be alert that welding sparks and hot materials from welding can easily go through small cracks and openings to adjacent areas.
- Watch for fire, and keep a fire extinguisher nearby.
- Be aware that welding on a ceiling, floor, bulkhead, or partition can cause fire on the hidden side.

- Do not cut or weld on tire rims or wheels. Tires can explode if heated. Repaired rims and wheels can fail. See OSHA 29 CFR 1910.177 listed in Safety Standards.
- Do not weld on containers that have held combustibles, or on closed containers such as tanks, drums, or pipes unless they are properly prepared according to AWS F4.1 and AWS A6.0 (see Safety Standards).
- Do not weld where the atmosphere can contain flammable dust, gas, or liquid vapors (such as gasoline).
- Connect work cable to the work as close to the welding area as practical to prevent welding current from traveling long, possibly unknown paths and causing electric shock, sparks, and fire hazards.
- Do not use welder to thaw frozen pipes.
- Remove stick electrode from holder or cut off welding wire at contact tip when not in use.
- Wear body protection made from durable, flame-resistant material (leather, heavy cotton, wool). Body protection includes oil-free clothing such as leather gloves, heavy shirt, cuffless trousers, high shoes, and a cap.
- Remove any combustibles, such as a butane lighter or matches, from your person before doing any welding.
- After completion of work, inspect area to ensure it is free of sparks, glowing embers, and flames.
- Use only correct fuses or circuit breakers. Do not oversize or bypass them.
- Follow requirements in OSHA 1910.252 (a) (2) (iv) and NFPA 51B for hot work and have a fire watcher and extinguisher nearby.
- Read and understand the Safety Data Sheets (SDSs) and the manufacturer's instructions for adhesives, coatings, cleaners, consumables, coolants, degreasers, fluxes, and metals.

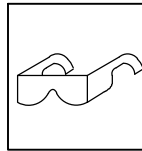

### FLYING METAL or DIRT can injure eyes.

- Welding, chipping, wire brushing, and grinding cause sparks and flying metal. As welds cool, they can throw off slag.
- Wear approved safety glasses with side shields even under your welding helmet.



### BUILDUP OF GAS can injure or kill.

- Shut off compressed gas supply when not in use.
- Always ventilate confined spaces or use approved air-supplied respirator.

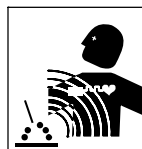

### ELECTRIC AND MAGNETIC FIELDS (EMF) can affect Implanted Medical Devices.

- Wearers of Pacemakers and other Implanted Medical Devices should keep away.
- Implanted Medical Device wearers should consult their doctor and the device manufacturer before going near arc welding, spot welding, gouging, plasma arc cutting, or induction heating operations.

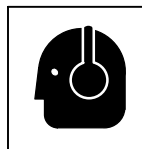

### NOISE can damage hearing.

Noise from some processes or equipment can damage hearing.

- Wear approved ear protection if noise level is high.



### CYLINDERS can explode if damaged.

Compressed gas cylinders contain gas under high pressure. If damaged, a cylinder can explode. Since gas cylinders are normally part of the welding process, be sure to treat them carefully.

- Protect compressed gas cylinders from excessive heat, mechanical shocks, physical damage, slag, open flames, sparks, and arcs.
- Install cylinders in an upright position by securing to a stationary support or cylinder rack to prevent falling or tipping.
- Keep cylinders away from any welding or other electrical circuits.
- Never drape a welding torch over a gas cylinder.
- Never allow a welding electrode to touch any cylinder.

- Never weld on a pressurized cylinder – explosion will result.
- Use only correct compressed gas cylinders, regulators, hoses, and fittings designed for the specific application; maintain them and associated parts in good condition.
- Turn face away from valve outlet when opening cylinder valve. Do not stand in front of or behind the regulator when opening the valve.
- Keep protective cap in place over valve except when cylinder is in use or connected for use.
- Use the proper equipment, correct procedures, and sufficient number of persons to lift, move, and transport cylinders.
- Read and follow instructions on compressed gas cylinders, associated equipment, and Compressed Gas Association (CGA) publication P-1 listed in Safety Standards.

## 1-3. Additional Symbols For Installation, Operation, And Maintenance



### FIRE OR EXPLOSION hazard.

- Do not install or place unit on, over, or near combustible surfaces.
- Do not install unit near flammables.
- Do not overload building wiring – be sure power supply system is properly sized, rated, and protected to handle this unit.



### FALLING EQUIPMENT can injure.

- Use lifting eye to lift unit only, NOT running gear, gas cylinders, or any other accessories.
- Use correct procedures and equipment of adequate capacity to lift and support unit.
- If using lift forks to move unit, be sure forks are long enough to extend beyond opposite side of unit.
- Keep equipment (cables and cords) away from moving vehicles when working from an aerial location.
- Follow the guidelines in the Applications Manual for the Revised NIOSH Lifting Equation (Publication No. 94-110) when manually lifting heavy parts or equipment.

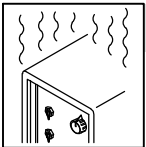

### OVERUSE can cause OVERHEATING

- Allow cooling period; follow rated duty cycle.
- Reduce current or reduce duty cycle before starting to weld again.
- Do not block or filter airflow to unit.

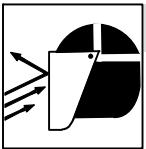

### FLYING SPARKS can injure.

- Wear a face shield to protect eyes and face.
- Shape tungsten electrode only on grinder with proper guards in a safe location wearing proper face, hand, and body protection.
- Sparks can cause fires — keep flammables away.

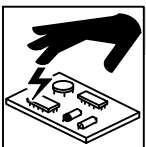

### STATIC (ESD) can damage PC boards.

- Put on grounded wrist strap BEFORE handling boards or parts.
- Use proper static-proof bags and boxes to store, move, or ship PC boards.

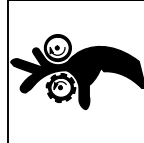

### MOVING PARTS can injure.

- Keep away from moving parts.
- Keep away from pinch points such as drive rolls.



### WELDING WIRE can injure.

- Do not press gun trigger until instructed to do so.
- Do not point gun toward any part of the body, other people, or any metal when threading welding wire.

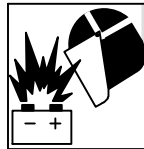

### BATTERY EXPLOSION can injure.

- Do not use welder to charge batteries or jump start vehicles unless it has a battery charging feature designed for this purpose.



### MOVING PARTS can injure.

- Keep away from moving parts such as fans.
- Keep all doors, panels, covers, and guards closed and securely in place.
- Have only qualified persons remove doors, panels, covers, or guards for maintenance and troubleshooting as necessary.
- Reinstall doors, panels, covers, or guards when maintenance is finished and before reconnecting input power.

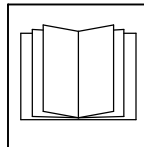

### READ INSTRUCTIONS.

- Read and follow all labels and the Owner's Manual carefully before installing, operating, or servicing unit. Read the safety information at the beginning of the manual and in each section.
- Use only genuine replacement parts from the manufacturer.
- Perform installation, maintenance, and service according to the Owner's Manuals, industry standards, and national, state, and local codes.



#### H.F. RADIATION can cause interference.

- High-frequency (H.F.) can interfere with radio navigation, safety services, computers, and communications equipment.
- Have only qualified persons familiar with electronic equipment perform this installation.
- The user is responsible for having a qualified electrician promptly correct any interference problem resulting from the installation.
- If notified by the FCC about interference, stop using the equipment at once.
- Have the installation regularly checked and maintained.
- Keep high-frequency source doors and panels tightly shut, keep spark gaps at correct setting, and use grounding and shielding to minimize the possibility of interference.

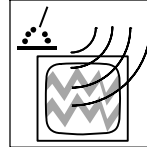

#### ARC WELDING can cause interference.

- Electromagnetic energy can interfere with sensitive electronic equipment such as computers and computer-driven equipment such as robots.
- Be sure all equipment in the welding area is electromagnetically compatible.
- To reduce possible interference, keep weld cables as short as possible, close together, and down low, such as on the floor.
- Locate welding operation 100 meters from any sensitive electronic equipment.
- Be sure this welding machine is installed and grounded according to this manual.
- If interference still occurs, the user must take extra measures such as moving the welding machine, using shielded cables, using line filters, or shielding the work area.

### 1-4. California Proposition 65 Warnings

**⚠ WARNING:** This product can expose you to chemicals including lead, which are known to the state of California to cause cancer and birth defects or other reproductive harm.

For more information, go to [www.P65Warnings.ca.gov](http://www.P65Warnings.ca.gov)

### 1-5. Principal Safety Standards

*Safety in Welding, Cutting, and Allied Processes*, ANSI Standard Z49.1, is available as a free download from the American Welding Society at <http://www.aws.org> or purchased from Global Engineering Documents (phone: 1-877-413-5184, website: [www.global.ihs.com](http://www.global.ihs.com)).

*Safe Practices for the Preparation of Containers and Piping for Welding and Cutting*, American Welding Society Standard AWS F4.1, from Global Engineering Documents (phone: 1-877-413-5184, website: [www.global.ihs.com](http://www.global.ihs.com)).

*Safe Practices for Welding and Cutting Containers that have Held Combustibles*, American Welding Society Standard AWS A6.0, from Global Engineering Documents (phone: 1-877-413-5184, website: [www.global.ihs.com](http://www.global.ihs.com)).

*National Electrical Code*, NFPA Standard 70, from National Fire Protection Association, Quincy, MA 02169 (phone: 1-800-344-3555, website: [www.nfpa.org](http://www.nfpa.org) and [www.sparky.org](http://www.sparky.org)).

*Safe Handling of Compressed Gases in Cylinders*, CGA Pamphlet P-1, from Compressed Gas Association, 14501 George Carter Way, Suite 103, Chantilly, VA 20151 (phone: 703-788-2700, website: [www.cganet.com](http://www.cganet.com)).

*Safety in Welding, Cutting, and Allied Processes*, CSA Standard W117.2, from Canadian Standards Association, Standards Sales, 5060 Spectrum Way, Suite 100, Mississauga, Ontario, Canada L4W 5N5 (phone: 800-463-6727, website: [www.csagroup.org](http://www.csagroup.org)).

*Safe Practice For Occupational And Educational Eye And Face Protection*, ANSI Standard Z87.1, from American National Standards Institute, 25 West 43rd Street, New York, NY 10036 (phone: 212-642-4900, website: [www.ansi.org](http://www.ansi.org)).

*Standard for Fire Prevention During Welding, Cutting, and Other Hot Work*, NFPA Standard 51B, from National Fire Protection Association, Quincy, MA 02169 (phone: 1-800-344-3555, website: [www.nfpa.org](http://www.nfpa.org)).

OSHA, Occupational Safety and Health Standards for General Industry, Title 29, Code of Federal Regulations (CFR), Part 1910.177 Subpart N, Part 1910 Subpart Q, and Part 1926, Subpart J, from U.S. Government Printing Office, Superintendent of Documents, P.O. Box 371954, Pittsburgh, PA 15250-7954 (phone: 1-866-512-1800) (there are 10 OSHA Regional Offices—phone for Region 5, Chicago, is 312-353-2220, website: [www.osha.gov](http://www.osha.gov)).

*Applications Manual for the Revised NIOSH Lifting Equation*, The National Institute for Occupational Safety and Health (NIOSH), 1600 Clifton Rd, Atlanta, GA 30329-4027 (phone: 1-800-232-4636, website: [www.cdc.gov/NIOSH](http://www.cdc.gov/NIOSH)).

### 1-6. EMF Information

Electric current flowing through any conductor causes localized electric and magnetic fields (EMF). The current from arc welding (and allied processes including spot welding, gouging, plasma arc cutting, and induction heating operations) creates an EMF field around the welding circuit. EMF fields can interfere with some medical implants, e.g. pacemakers. Protective measures for persons wearing medical implants have to be taken. For example, restrict access for passers-by or conduct individual risk assessment for welders. All welders should use the following procedures in order to minimize exposure to EMF fields from the welding circuit:

1. Keep cables close together by twisting or taping them, or using a cable cover.
2. Do not place your body between welding cables. Arrange cables to one side and away from the operator.
3. Do not coil or drape cables around your body.

4. Keep head and trunk as far away from the equipment in the welding circuit as possible.
5. Connect work clamp to workpiece as close to the weld as possible.
6. Do not work next to, sit or lean on the welding power source.
7. Do not weld whilst carrying the welding power source or wire feeder.

#### About Implanted Medical Devices:

Implanted Medical Device wearers should consult their doctor and the device manufacturer before performing or going near arc welding, spot welding, gouging, plasma arc cutting, or induction heating operations. If cleared by your doctor, then following the above procedures is recommended.

# SECTION 2 – CONSIGNES DE SÉCURITÉ – LIRE AVANT UTILISATION

som\_2018-01\_fre

**⚠** Pour écarter les risques de blessure pour vous-même et pour autrui — lire, appliquer et ranger en lieu sûr ces consignes relatives aux précautions de sécurité et au mode opératoire.

## 2-1. Symboles utilisés



**DANGER!** – Indique une situation dangereuse qui si on l'évite pas peut donner la mort ou des blessures graves. Les dangers possibles sont montrés par les symboles joints ou sont expliqués dans le texte.



Indique une situation dangereuse qui si on l'évite pas peut donner la mort ou des blessures graves. Les dangers possibles sont montrés par les symboles joints ou sont expliqués dans le texte.

**AVIS** – Indique des déclarations pas en relation avec des blessures personnelles.

 Indique des instructions spécifiques.



Ce groupe de symboles veut dire Avertissement! Attention! DANGER DE CHOC ÉLECTRIQUE, PIÈCES EN MOUVEMENT, et PIÈCES CHAUDES. Consulter les symboles et les instructions ci-dessous y afférant pour les actions nécessaires afin d'éviter le danger.

## 2-2. Dangers relatifs au soudage à l'arc



Les symboles représentés ci-dessous sont utilisés dans ce manuel pour attirer l'attention et identifier les dangers possibles. En présence de l'un de ces symboles, prendre garde et suivre les instructions afférentes pour éviter tout risque. Les instructions en matière de sécurité indiquées ci-dessous ne constituent qu'un sommaire des instructions de sécurité plus complètes fournies dans les normes de sécurité énumérées dans la Section 2-5. Lire et observer toutes les normes de sécurité.



L'installation, l'utilisation, l'entretien et les réparations ne doivent être confiés qu'à des personnes qualifiées. Une personne qualifiée est définie comme celle qui, par la possession d'un diplôme reconnu, d'un certificat ou d'un statut professionnel, ou qui, par une connaissance, une formation et une expérience approfondies, a démontré avec succès sa capacité à résoudre les problèmes liés à la tâche, le travail ou le projet et a reçu une formation en sécurité afin de reconnaître et d'éviter les risques inhérents.



Pendant le fonctionnement, maintenir à distance toutes les personnes, notamment les enfants de l'appareil.



### UNE DÉCHARGE ÉLECTRIQUE peut entraîner la mort.

Le contact d'organes électriques sous tension peut provoquer des accidents mortels ou des brûlures graves. Le circuit de l'électrode et de la pièce est sous tension lorsque le courant est délivré à la sortie. Le circuit d'alimentation et les circuits internes de la machine sont également sous tension lorsque l'alimentation est sur Marche. Dans le mode de soudage avec du fil, le fil, le dérouleur, le bloc de commande du rouleau et toutes les parties métalliques en contact avec le fil sont sous tension électrique. Un équipement installé ou mis à la terre de manière incorrecte ou impropre constitue un danger.

- Ne pas toucher aux pièces électriques sous tension.
- Porter des gants isolants et des vêtements de protection secs et sans trous.
- S'isoler de la pièce à couper et du sol en utilisant des housses ou des tapis assez grands afin d'éviter tout contact physique avec la pièce à couper ou le sol.
- Ne pas utiliser de sortie de soudage CA dans des zones humides ou confinées ou s'il y a un risque de chute.
- Se servir d'une source électrique à courant électrique UNIQUEMENT si le procédé de soudage le demande.
- Si l'utilisation d'une source électrique à courant électrique s'avère nécessaire, se servir de la fonction de télécommande si l'appareil en est équipé.
- D'autres consignes de sécurité sont nécessaires dans les conditions suivantes : risques électriques dans un environnement humide ou si l'on porte des vêtements mouillés ; sur des structures métalliques telles que sols, grilles ou échafaudages ; en position coincée comme assise, à genoux ou couchée ; ou s'il y a un risque élevé de contact inévitable ou accidentel avec la pièce à souder ou le sol. Dans ces conditions, utiliser les équipements suivants, dans l'ordre indiqué : 1) un poste à souder DC à tension constante (à fil), 2) un poste à souder DC manuel (électrode) ou 3) un poste à souder AC à tension à vide réduite. Dans la plupart des situations,

l'utilisation d'un poste à souder DC à fil à tension constante est recommandée. En outre, ne pas travailler seul !

- Couper l'alimentation ou arrêter le moteur avant de procéder à l'installation, à la réparation ou à l'entretien de l'appareil. Déverrouiller l'alimentation selon la norme OSHA 29 CFR 1910.147 (voir normes de sécurité).
- Installez, mettez à la terre et utilisez correctement cet équipement conformément à son Manuel d'Utilisation et aux réglementations nationales, gouvernementales et locales.
- Toujours vérifier la terre du cordon d'alimentation. Vérifier et s'assurer que le fil de terre du cordon d'alimentation est bien raccordé à la borne de terre du sectionneur ou que la fiche du cordon est raccordée à une prise correctement mise à la terre.
- En effectuant les raccordements d'entrée, fixer d'abord le conducteur de mise à la terre approprié et contre-vérifier les connexions.
- Les câbles doivent être exempts d'humidité, d'huile et de graisse; protégez-les contre les étincelles et les pièces métalliques chaudes.
- Vérifier fréquemment le cordon d'alimentation et le conducteur de mise à la terre afin de s'assurer qu'il n'est pas altéré ou dénudé -, le remplacer immédiatement s'il l'est -. Un fil dénudé peut entraîner la mort.
- L'équipement doit être hors tension lorsqu'il n'est pas utilisé.
- Ne pas utiliser des câbles usés, endommagés, de grosseur insuffisante ou mal épissés.
- Ne pas enrouler les câbles autour du corps.
- Si la pièce soudée doit être mise à la terre, le faire directement avec un câble distinct.
- Ne pas toucher l'électrode quand on est en contact avec la pièce, la terre ou une électrode provenant d'une autre machine.
- Ne pas toucher des porte électrodes connectés à deux machines en même temps à cause de la présence d'une tension à vide doublée.
- N'utiliser qu'un matériel en bon état. Réparer ou remplacer sur-le-champ les pièces endommagées. Entretenir l'appareil conformément à ce manuel.
- Porter un harnais de sécurité si l'on doit travailler au-dessus du sol.
- S'assurer que tous les panneaux et couvercles sont correctement en place.
- Fixer le câble de retour de façon à obtenir un bon contact métal-métal avec la pièce à souder ou la table de travail, le plus près possible de la soudure.
- Isoler la pince de masse quand pas mis à la pièce pour éviter le contact avec tout objet métallique.
- Ne pas raccorder plus d'une électrode ou plus d'un câble de masse à une même borne de sortie de soudage. Débrancher le câble pour le procédé non utilisé.
- Utiliser une protection différentielle lors de l'utilisation d'un équipement auxiliaire dans des endroits humides ou mouillés.

### Il reste une TENSION DC NON NÉGLIGEABLE dans les sources de soudage onduleur UNE FOIS l'alimentation coupée.

- Éteignez l'unité, débranchez le courant électrique, et déchargez les condensateurs d'alimentation selon les instructions indiquées dans le manuel avant de toucher les pièces.



### LES PIÈCES CHAUDES peuvent provoquer des brûlures.

- Ne pas toucher à mains nues les parties chaudes.
- Prévoir une période de refroidissement avant de travailler à l'équipement.

- Ne pas toucher aux pièces chaudes, utiliser les outils recommandés et porter des gants de soudage et des vêtements épais pour éviter les brûlures.



### LES FUMÉES ET LES GAZ peuvent être dangereux.

Le soudage génère des fumées et des gaz. Leur inhalation peut être dangereux pour votre santé.

- Eloigner votre tête des fumées. Ne pas respirer les fumées.
- À l'intérieur, ventiler la zone et/ou utiliser une ventilation forcée au niveau de l'arc pour l'évacuation des fumées et des gaz de soudage. Pour déterminer la bonne ventilation, il est recommandé de procéder à un prélèvement pour la composition et la quantité de fumées et de gaz auxquelles est exposé le personnel.
- Si la ventilation est médiocre, porter un respirateur anti-vapeurs approuvé.
- Lire et comprendre les fiches de données de sécurité et les instructions du fabricant concernant les adhésifs, les revêtements, les nettoyants, les consommables, les produits de refroidissement, les dégraisseurs, les flux et les métaux.
- Travailler dans un espace fermé seulement s'il est bien ventilé ou en portant un respirateur à alimentation d'air. Demander toujours à un surveillant dûment formé de se tenir à proximité. Des fumées et des gaz de soudage peuvent déplacer l'air et abaisser le niveau d'oxygène provoquant des blessures ou des accidents mortels. S'assurer que l'air de respiration ne présente aucun danger.
- Ne pas souder dans des endroits situés à proximité d'opérations de dégraissage, de nettoyage ou de pulvérisation. La chaleur et les rayons de l'arc peuvent réagir en présence de vapeurs et former des gaz hautement toxiques et irritants.
- Ne pas souder des métaux munis d'un revêtement, tels que l'acier galvanisé, plaqué en plomb ou au cadmium à moins que le revêtement n'ait été enlevé dans la zone de soudure, que l'endroit soit bien ventilé, et en portant un respirateur à alimentation d'air. Les revêtements et tous les métaux renfermant ces éléments peuvent dégager des fumées toxiques en cas de soudage.



### LES RAYONS DE L'ARC peuvent provoquer des brûlures dans les yeux et sur la peau.

Le rayonnement de l'arc du procédé de soudage génère des rayons visibles et invisibles intenses (ultraviolets et infrarouges) susceptibles de provoquer des brûlures dans les yeux et sur la peau. Des étincelles sont projetées pendant le soudage.

- Porter un casque de soudage approuvé muni de verres filtrants appropriés pour protéger visage et yeux pour protéger votre visage et vos yeux pendant le soudage ou pour regarder (voir ANSI Z49.1 et Z87.1 énuméré dans les normes de sécurité).
- Porter des lunettes de sécurité avec écrans latéraux même sous votre casque.
- Avoir recours à des écrans protecteurs ou à des rideaux pour protéger les autres contre les rayonnements les éblouissements et les étincelles ; prévenir toute personne sur les lieux de ne pas regarder l'arc.
- Porter un équipement de protection pour le corps fait d'un matériau résistant et ignifuge (cuir, coton robuste, laine). La protection du corps comporte des vêtements sans huile comme par ex. des gants de cuir, une chemise solide, des pantalons sans revers, des chaussures hautes et une casquette.



### LE SOUDAGE peut provoquer un incendie ou une explosion.

Le soudage effectué sur des conteneurs fermés tels que des réservoirs, tambours ou des conduites peut provoquer leur éclatement. Des étincelles peuvent être projetées de l'arc de soudure. La projection d'étincelles, des pièces chaudes et des équipements chauds peut provoquer des incendies et des brûlures. Le contact accidentel de l'électrode avec des objets métalliques peut provoquer des étincelles, une explosion, un surchauffement ou un incendie. Avant de commencer le soudage, vérifier et s'assurer que l'endroit ne présente pas de danger.

- Déplacer toutes les substances inflammables à une distance de 10,7 m de l'arc de soudage. En cas d'impossibilité les recouvrir soigneusement avec des protections homologués.
- Ne pas souder dans un endroit où des étincelles peuvent tomber sur des substances inflammables.
- Se protéger et d'autres personnes de la projection d'étincelles et de métal chaud.
- Des étincelles et des matériaux chauds du soudage peuvent facilement passer dans d'autres zones en traversant de petites fissures et des ouvertures.
- Surveiller tout déclenchement d'incendie et tenir un extincteur à proximité.
- Le soudage effectué sur un plafond, plancher, paroi ou séparation peut déclencher un incendie de l'autre côté.
- Ne pas couper ou souder des jantes ou des roues. Les pneus peuvent exploser s'ils sont chauffés. Les jantes et les roues réparées peuvent défaillir. Voir OSHA 29 CFR 1910.177 énuméré dans les normes de sécurité.
- Ne pas effectuer le soudage sur des conteneurs fermés tels que des réservoirs, tambours, ou conduites, à moins qu'ils n'aient été préparés correctement conformément à AWS F4.1 et AWS A6.0 (voir les Normes de Sécurité).
- Ne pas souder là où l'air ambiant pourrait contenir des poussières, gaz ou émanations inflammables (vapeur d'essence, par exemple).
- Brancher le câble de masse sur la pièce la plus près possible de la zone de soudage pour éviter le transport du courant sur une longue distance par des chemins inconnus éventuels en provoquant des risques d'électrocution, d'étincelles et d'incendie.
- Ne pas utiliser le poste de soudage pour dégeler des conduites gelées.
- En cas de non utilisation, enlever la baguette d'électrode du porte-électrode ou couper le fil à la pointe de contact.
- Porter un équipement de protection pour le corps fait d'un matériau résistant et ignifuge (cuir, coton robuste, laine). La protection du corps comporte des vêtements sans huile comme par ex. des gants de cuir, une chemise solide, des pantalons sans revers, des chaussures hautes et une casquette.
- Avant de souder, retirer toute substance combustible de vos poches telles qu'un allumeur au butane ou des allumettes.
- Une fois le travail achevé, assurez-vous qu'il ne reste aucune trace d'étincelles incandescentes ni de flammes.
- Utiliser exclusivement des fusibles ou coupe-circuits appropriés. Ne pas augmenter leur puissance; ne pas les ponter.
- Suivre les recommandations dans OSHA 1910.252(a)(2)(iv) et NFPA 51B pour les travaux à chaud et avoir de la surveillance et un extincteur à proximité.
- Lire et comprendre les fiches de données de sécurité et les instructions du fabricant concernant les adhésifs, les revêtements, les nettoyants, les consommables, les produits de refroidissement, les dégraisseurs, les flux et les métaux.

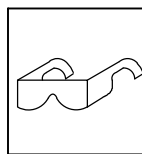

### DES PIÈCES DE METAL ou DES SALETES peuvent provoquer des blessures dans les yeux.

- Le soudage, l'écaillage, le passage de la pièce à la brosse en fil de fer, et le meulage génèrent des étincelles et des particules métalliques volantes. Pendant la période de refroidissement des soudures, elles risquent de projeter du laitier.
- Porter des lunettes de sécurité avec écrans latéraux ou un écran facial.



### LES ACCUMULATIONS DE GAZ risquent de provoquer des blessures ou même la mort.

- Fermer l'alimentation du gaz comprimé en cas de non utilisation.
- Veiller toujours à bien aérer les espaces confinés ou se servir d'un respirateur d'adduction d'air homologué.



### Les CHAMPS ÉLECTROMAGNÉTIQUES (CEM) peuvent affecter les implants médicaux.

- Les porteurs de stimulateurs cardiaques et autres implants médicaux doivent rester à distance.
- Les porteurs d'implants médicaux doivent consulter leur médecin et le fabricant du dispositif avant de s'approcher de la zone où se déroule du soudage à l'arc, du soudage par points, du gougeage, de la découpe plasma ou une opération de chauffage par induction.

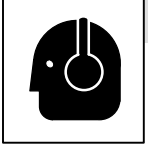

### LE BRUIT peut endommager l'ouïe.

Le bruit des processus et des équipements peut affecter l'ouïe.

- Porter des protections approuvées pour les oreilles si le niveau sonore est trop élevé.

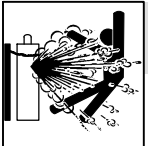

### LES BOUTEILLES peuvent exploser si elles sont endommagées.

Les bouteilles de gaz comprimé contiennent du gaz sous haute pression. Si une bouteille est endommagée, elle peut exploser. Du fait que

les bouteilles de gaz font normalement partie du procédé de soudage, les manipuler avec précaution.

- Protéger les bouteilles de gaz comprimé d'une chaleur excessive, des chocs mécaniques, des dommages physiques, du laitier, des flammes ouvertes, des étincelles et des arcs.
- Placer les bouteilles debout en les fixant dans un support stationnaire ou dans un porte-bouteilles pour les empêcher de tomber ou de se renverser.
- Tenir les bouteilles éloignées des circuits de soudage ou autres circuits électriques.
- Ne jamais placer une torche de soudage sur une bouteille à gaz.
- Une électrode de soudage ne doit jamais entrer en contact avec une bouteille.
- Ne jamais souder une bouteille pressurisée – risque d'explosion.
- Utiliser seulement des bouteilles de gaz comprimé, régulateurs, tuyaux et raccords convenables pour cette application spécifique; les maintenir ainsi que les éléments associés en bon état.
- Tourner le dos à la sortie de vanne lors de l'ouverture de la vanne de la bouteille. Ne pas se tenir devant ou derrière le régulateur lors de l'ouverture de la vanne.
- Le couvercle du détendeur doit toujours être en place, sauf lorsque la bouteille est utilisée ou qu'elle est reliée pour usage ultérieur.
- Utilisez les équipements corrects, les bonnes procédures et suffisamment de personnes pour soulever, déplacer et transporter les bouteilles.
- Lire et suivre les instructions sur les bouteilles de gaz comprimé, l'équipement connexe et le dépliant P-1 de la CGA (Compressed Gas Association) mentionné dans les principales normes de sécurité.

## 2-3. Dangers supplémentaires en relation avec l'installation, le fonctionnement et la maintenance



### Risque D'INCENDIE OU D'EXPLOSION.

- Ne pas placer l'appareil sur, au-dessus ou à proximité de surfaces inflammables.
- Ne pas installer l'appareil à proximité de produits inflammables.
- Ne pas surcharger l'installation électrique – s'assurer que l'alimentation est correctement dimensionnée et protégée avant de mettre l'appareil en service.



### LA CHUTE DE L'ÉQUIPEMENT peut provoquer des blessures.

- Utiliser l'anneau de levage uniquement pour soulever l'appareil, NON PAS les chariots, les bouteilles de gaz ou tout autre accessoire.
- Utilisez les procédures correctes et des équipements d'une capacité appropriée pour soulever et supporter l'appareil.
- En utilisant des fourches de levage pour déplacer l'unité, s'assurer que les fourches sont suffisamment longues pour dépasser du côté opposé de l'appareil.
- Tenir l'équipement (câbles et cordons) à distance des véhicules mobiles lors de toute opération en hauteur.
- Suivre les consignes du Manuel des applications pour l'équation de levage NIOSH révisée (Publication N°94-110) lors du levage manuel de pièces ou équipements lourds.

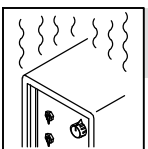

### L'EMPLOI EXCESSIF peut SURCHAUFFER L'ÉQUIPEMENT.

- Prévoir une période de refroidissement ; respecter le cycle opératoire nominal.
- Réduire le courant ou le facteur de marche avant de poursuivre le soudage.
- Ne pas obstruer les passages d'air du poste.

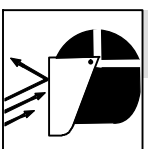

### LES ÉTINCELLES PROJÉTÉES peuvent provoquer des blessures.

- Porter un écran facial pour protéger le visage et les yeux.
- Affûter l'électrode au tungstène uniquement à la meuleuse dotée de protecteurs. Cette manœuvre est à exécuter dans un endroit sûr lorsque l'on porte l'équipement homologué de protection du visage, des mains et du corps.
- Les étincelles risquent de causer un incendie – éloigner toute substance inflammable.

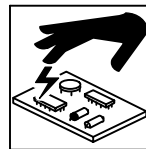

### LES CHARGES ÉLECTROSTATIQUES peuvent endommager les circuits imprimés.

- Établir la connexion avec la barrette de terre avant de manipuler des cartes ou des pièces.
- Utiliser des pochettes et des boîtes antistatiques pour stocker, déplacer ou expédier des cartes de circuits imprimés.

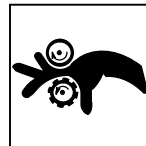

### Les PIÈCES MOBILES peuvent causer des blessures.

- Ne pas s'approcher des organes mobiles.
- Ne pas s'approcher des points de coincement tels que des rouleaux de commande.



### LES FILS DE SOUDAGE peuvent provoquer des blessures.

- Ne pas appuyer sur la gâchette avant d'en avoir reçu l'instruction.
- Ne pas diriger le pistolet vers soi, d'autres personnes ou toute pièce mécanique en engageant le fil de soudage.

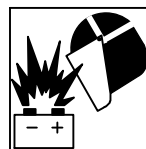

### L'EXPLOSION DE LA BATTERIE peut provoquer des blessures.

- Ne pas utiliser l'appareil de soudage pour charger des batteries ou faire démarrer des véhicules à l'aide de câbles de démarrage, sauf si l'appareil dispose d'une fonctionnalité de charge de batterie destinée à cet usage.



### Les PIÈCES MOBILES peuvent causer des blessures.

- S'abstenir de toucher des organes mobiles tels que des ventilateurs.
- Maintenir fermés et verrouillés les portes, panneaux, recouvrements et dispositifs de protection.
- Lorsque cela est nécessaire pour des travaux d'entretien et de dépannage, faire retirer les portes, panneaux, recouvrements ou dispositifs de protection uniquement par du personnel qualifié.
- Remettre les portes, panneaux, recouvrements ou dispositifs de protection quand l'entretien est terminé et avant de rebrancher l'alimentation électrique.

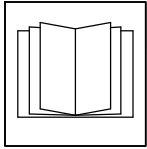

### LIRE LES INSTRUCTIONS.

- Lire et appliquer les instructions sur les étiquettes et le Mode d'emploi avant l'installation, l'utilisation ou l'entretien de l'appareil. Lire les informations de sécurité au début du manuel et dans chaque section.

- N'utiliser que les pièces de rechange recommandées par le constructeur.
- Effectuer l'installation, l'entretien et toute intervention selon les manuels d'utilisateurs, les normes nationales, provinciales et de l'industrie, ainsi que les codes municipaux.

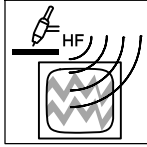

### LE RAYONNEMENT HAUTE FRÉQUENCE (H.F.) risque de provoquer des interférences.

- Le rayonnement haute fréquence (H.F.) peut provoquer des interférences avec les équipements de radio-navigation et de communication, les services de sécurité et les ordinateurs.
- Demander seulement à des personnes qualifiées familiarisées avec des équipements électroniques de faire fonctionner l'installation.
- L'utilisateur est tenu de faire corriger rapidement par un électricien qualifié les interférences résultant de l'installation.
- Si le FCC signale des interférences, arrêter immédiatement l'appareil.

- Effectuer régulièrement le contrôle et l'entretien de l'installation.
- Maintenir soigneusement fermés les portes et les panneaux des sources de haute fréquence, maintenir les éclateurs à une distance correcte et utiliser une terre et un blindage pour réduire les interférences éventuelles.



### LE SOUDAGE À L'ARC risque de provoquer des interférences.

- L'énergie électromagnétique risque de provoquer des interférences pour l'équipement électronique sensible tel que les ordinateurs et l'équipement commandé par ordinateur tel que les robots.
- Veiller à ce que tout l'équipement de la zone de soudage soit compatible électromagnétiquement.
- Pour réduire la possibilité d'interférence, maintenir les câbles de soudage aussi courts que possible, les grouper, et les poser aussi bas que possible (ex. par terre).
- Veiller à souder à une distance de 100 mètres de tout équipement électronique sensible.
- Veiller à ce que ce poste de soudage soit posé et mis à la terre conformément à ce mode d'emploi.
- En cas d'interférences après avoir pris les mesures précédentes, il incombe à l'utilisateur de prendre des mesures supplémentaires telles que le déplacement du poste, l'utilisation de câbles blindés, l'utilisation de filtres de ligne ou la pose de protecteurs dans la zone de travail.

## 2-4. Proposition californienne 65 Avertissements

**⚠ AVERTISSEMENT : ce produit peut vous exposer à des produits chimiques tels que le plomb, reconnus par l'État de Californie comme cancérigènes et sources de malformations ou d'autres troubles de la reproduction.**

Pour plus d'informations, consulter [www.P65Warnings.ca.gov](http://www.P65Warnings.ca.gov)

## 2-5. Principales normes de sécurité

*Safety in Welding, Cutting, and Allied Processes*, ANSI Standard Z49.1, is available as a free download from the American Welding Society at <http://www.aws.org> or purchased from Global Engineering Documents (phone: 1-877-413-5184, website: [www.global.ihc.com](http://www.global.ihc.com)).

*Safe Practices for the Preparation of Containers and Piping for Welding and Cutting*, American Welding Society Standard AWS F4.1, from Global Engineering Documents (phone: 1-877-413-5184, website: [www.global.ihc.com](http://www.global.ihc.com)).

*Safe Practices for Welding and Cutting Containers that have Held Combustibles*, American Welding Society Standard AWS A6.0, from Global Engineering Documents (phone: 1-877-413-5184, website: [www.global.ihc.com](http://www.global.ihc.com)).

*National Electrical Code*, NFPA Standard 70, from National Fire Protection Association, Quincy, MA 02169 (phone: 1-800-344-3555, website: [www.nfpa.org](http://www.nfpa.org) and [www.sparky.org](http://www.sparky.org)).

*Safe Handling of Compressed Gases in Cylinders*, CGA Pamphlet P-1, from Compressed Gas Association, 14501 George Carter Way, Suite 103, Chantilly, VA 20151 (phone: 703-788-2700, website: [www.cganet.com](http://www.cganet.com)).

*Safety in Welding, Cutting, and Allied Processes*, CSA Standard W117.2, from Canadian Standards Association, Standards Sales, 5060 Spec-

trum Way, Suite 100, Mississauga, Ontario, Canada L4W 5N5 (phone: 800-463-6727, website: [www.csagroup.org](http://www.csagroup.org)).

*Safe Practice For Occupational And Educational Eye And Face Protection*, ANSI Standard Z87.1, from American National Standards Institute, 25 West 43rd Street, New York, NY 10036 (phone: 212-642-4900, website: [www.ansi.org](http://www.ansi.org)).

*Standard for Fire Prevention During Welding, Cutting, and Other Hot Work*, NFPA Standard 51B, from National Fire Protection Association, Quincy, MA 02169 (phone: 1-800-344-3555, website: [www.nfpa.org](http://www.nfpa.org)). OSHA, Occupational Safety and Health Standards for General Industry, Title 29, Code of Federal Regulations (CFR), Part 1910.177 Subpart N, Part 1910 Subpart Q, and Part 1926, Subpart J, from U.S. Government Printing Office, Superintendent of Documents, P.O. Box 371954, Pittsburgh, PA 15250-7954 (phone: 1-866-512-1800) (there are 10 OSHA Regional Offices—phone for Region 5, Chicago, is 312-353-2220, website: [www.osha.gov](http://www.osha.gov)).

*Applications Manual for the Revised NIOSH Lifting Equation*, The National Institute for Occupational Safety and Health (NIOSH), 1600 Clifton Rd, Atlanta, GA 30329-4027 (phone: 1-800-232-4636, website: [www.cdc.gov/NIOSH](http://www.cdc.gov/NIOSH)).

## 2-6. Informations relatives aux CEM

Le courant électrique qui traverse tout conducteur génère des champs électromagnétiques (CEM) à certains endroits. Le courant issu d'un soudage à l'arc (et de procédés connexes, y compris le soudage par points, le gougeage, le découpage plasma et les opérations de chauffage par induction) crée un champ électromagnétique (CEM) autour du circuit de soudage. Les champs électromagnétiques produits peuvent causer interférence à certains implants médicaux, p. ex. les stimulateurs cardiaques. Des mesures de protection pour les porteurs d'implants médicaux doivent être prises: Limiter par exemple tout accès aux passants ou procéder à une évaluation des risques individuels pour les soudeurs. Tous les soudeurs doivent appliquer les procédures suivantes pour minimiser l'exposition aux CEM provenant du circuit de soudage:

1. Rassembler les câbles en les torsadant ou en les attachant avec du ruban adhésif ou avec une housse.
2. Ne pas se tenir au milieu des câbles de soudage. Disposer les

câbles d'un côté et à distance de l'opérateur.

3. Ne pas courber et ne pas entourer les câbles autour de votre corps.
4. Maintenir la tête et le torse aussi loin que possible du matériel du circuit de soudage.
5. Connecter la pince sur la pièce aussi près que possible de la soudure.
6. Ne pas travailler à proximité d'une source de soudage, ni s'asseoir ou se pencher dessus.
7. Ne pas souder tout en portant la source de soudage ou le dévidoir.



### En ce qui concerne les implants médicaux :

Les porteurs d'implants doivent d'abord consulter leur médecin avant de s'approcher des opérations de soudage à l'arc, de soudage par points, de gougeage, du coupage plasma ou de chauffage par induction. Si le médecin approuve, il est recommandé de suivre les procédures précédentes.

# SECTION 3 – DEFINITIONS











## 3-1. Additional Safety Symbols And Definitions

Some symbols are found only on CE products.

	Warning! Watch Out! There are possible hazards as shown by the symbols. <div style="text-align: right; font-size: small;">Safe1 2012-05</div>
	Drive rolls can injure fingers. <div style="text-align: right; font-size: small;">Safe32 2012-05</div>

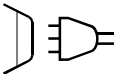
## 3-2. Miscellaneous Symbols And Definitions

Some symbols are found only on CE products.

<b>A</b>	Amperage	<b>V</b>	Voltage	<b>Hz</b>	Hertz	<b>—</b>	Negative
<b>+</b>	Positive	<b>≡</b>	Direct Current (DC)	<b>1</b> 	Single Phase		Input
	Output		Voltage Input	<b>○</b>	Off	<b> </b>	On
	Do Not Switch While Welding		Gas Metal Arc Welding (GMAW)	<b>⊘</b>	Wire Feed		Circuit Protector
<b>U<sub>0</sub></b>	Rated No Load Voltage (OCV)	<b>U<sub>1</sub></b>	Primary Voltage	<b>U<sub>2</sub></b>	Conventional Load Voltage		Line Connection
<b>I<sub>1max</sub></b>	Rated Maximum Supply Current	<b>I<sub>2</sub></b>	Rated Welding Current	<b>X</b>	Duty Cycle		Single Phase Transformer-Rectifier
	Temperature		Increase	<b>%</b>	Percent		Protective Earth (Ground)
<b>S</b>	Suitable For Welding In An Environment With Increased Risk Of Electric Shock	<b>I<sub>1</sub></b>	Rated Supply Current	<b>I<sub>1eff</sub></b>	Maximum Effective Supply Current		

## SECTION 4 – SPECIFICATIONS

### 4-1. Serial Number And Rating Label Location

The serial number and rating information for this product is located on the back. Use rating label to determine input power requirements and/or rated output. For future reference, write serial number in space provided on back cover of this manual.

### 4-2. Unit Specifications For 230 VAC

Do not use information in unit specifications table to determine electrical service requirements. See Sections 5-8 and 5-12 for information on connecting input power.

Rated Welding Output	Amperage Range	Maximum Open-Circuit Voltage DC	Amperes Input at Rated Load Output 230 V, 60 Hz, Single-Phase	KVA	KW	Weight W/ Gun	Overall Dimensions
150 A @ 23 Volts DC, 30% Duty Cycle	25 – 210	34	24	5.54	4.72	79 lb (36 kg)	Length: 19-1/2 in. (495 mm) Width: 10-5/8 in. (273 mm) Height: 12-3/8 in. (314 mm)
Wire Type And Diameter	Solid/Stainless	Flux Cored	Aluminum	Wire Feed Speed Range			
	.023 – .035 in. (0.6 – 0.9 mm)	.030 – .045 in. (0.8 – 1.2 mm)	.030 – .035 in. (0.8 – 0.9 mm)	70 – 750 IPM (1.8 – 19.0 m/min) At No Load 40 – 680 IPM (1.0 – 17.3 m/min) Feeding Wire			

### 4-3. Unit Specifications For 115 VAC

Do not use information in unit specifications table to determine electrical service requirements. See Sections 5-8 and 5-13 for information on connecting input power.

Rated Welding Output	Amperage Range		Maximum Open-Circuit Voltage DC	Amperes Input at Rated Load Output 120 V, 60 Hz, Single-Phase	KVA	KW	Weight W/ Gun	Overall Dimensions
90 A @ 19 Volts DC, 20% Duty Cycle	25 – 140		28	20	2.84	2.41	79 lb (36 kg)	Length: 19-1/2 in. (495 mm) Width: 10-5/8 in. (273 mm) Height: 12-3/8 in. (314 mm)
Wire Type And Diameter	Solid/Stainless	Flux Cored	Aluminum	Wire Feed Speed Range				
	.023 – .035 in. (0.6 – 0.9 mm)	.030 – .035 in. (0.8 – 0.9 mm)	.030 in. (0.8 mm)	60 – 740 IPM (1.5 – 18.8 m/min) At No Load 40 – 600 IPM (1.0 – 15.2 m/min) Feeding Wire				

## 4-4. Duty Cycle And Overheating

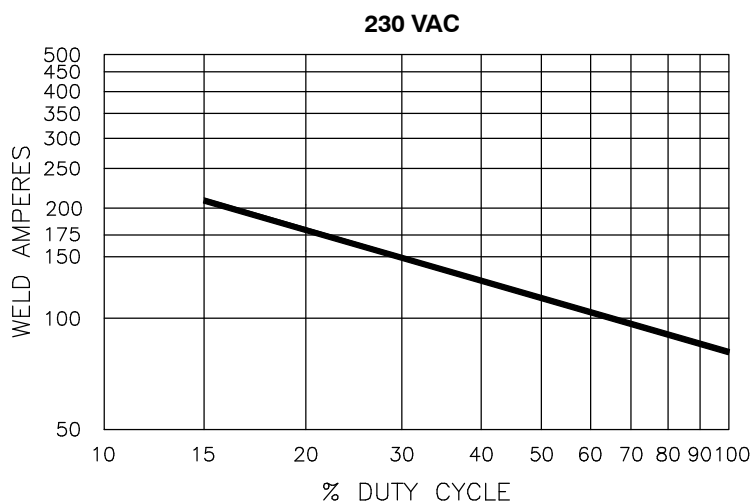

Duty Cycle is percentage of 10 minutes that unit can weld at rated load without overheating.

If unit overheats, thermostat(s) opens, output stops, and cooling fan runs. Wait fifteen minutes for unit to cool. Reduce amperage or duty cycle before welding.

**NOTICE** – Exceeding duty cycle can damage unit or gun and void warranty.

30% duty cycle at 150 amps

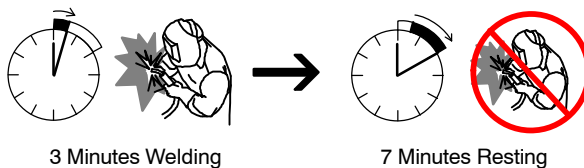

**115 VAC**

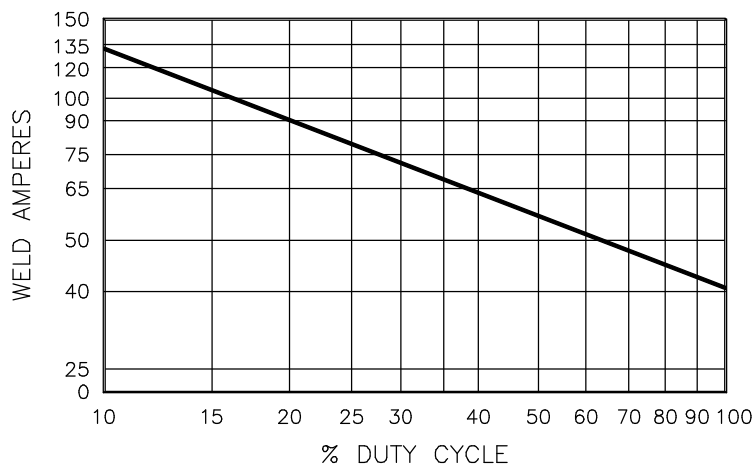

20% duty cycle at 90 amps

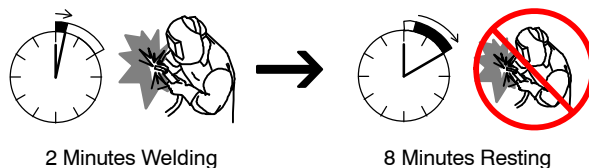

### Overheating

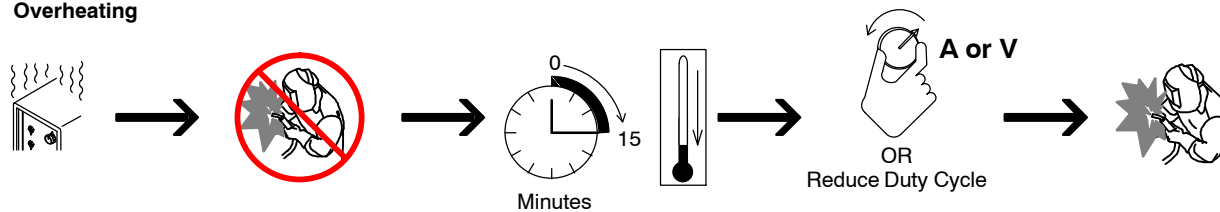

### 4-5. Volt-Ampere Curves

The volt-ampere curves show the minimum and maximum voltage and amperage output capabilities of the welding power source. Curves of other settings fall between the curves shown.

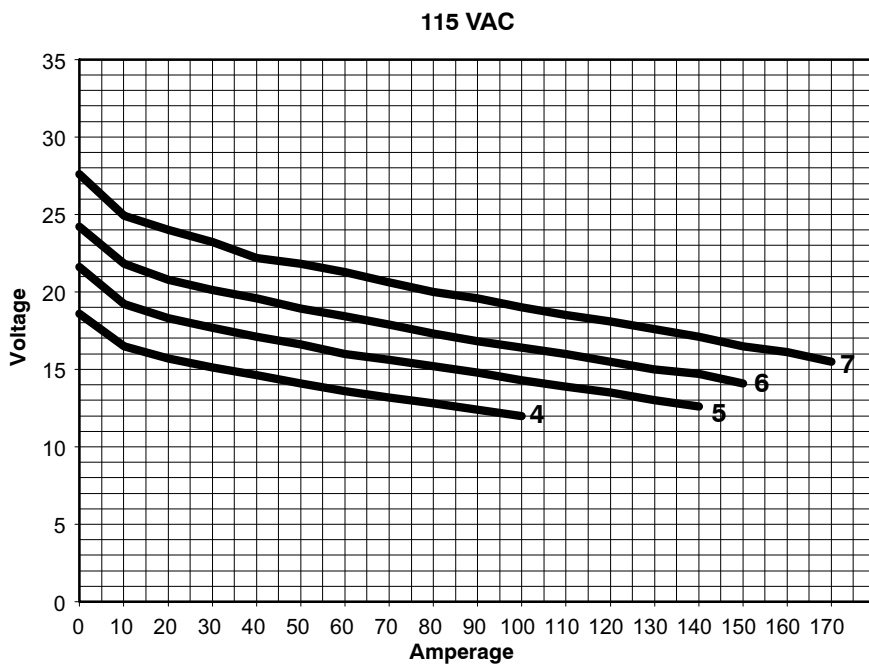
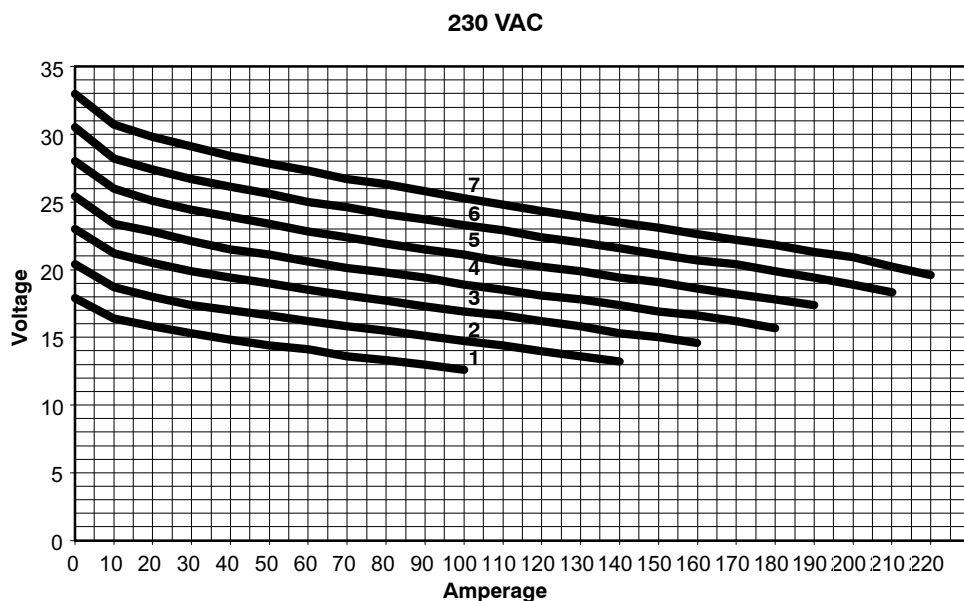

## SECTION 5 – INSTALLATION

### 5-1. Selecting A Location



**Location And Airflow**

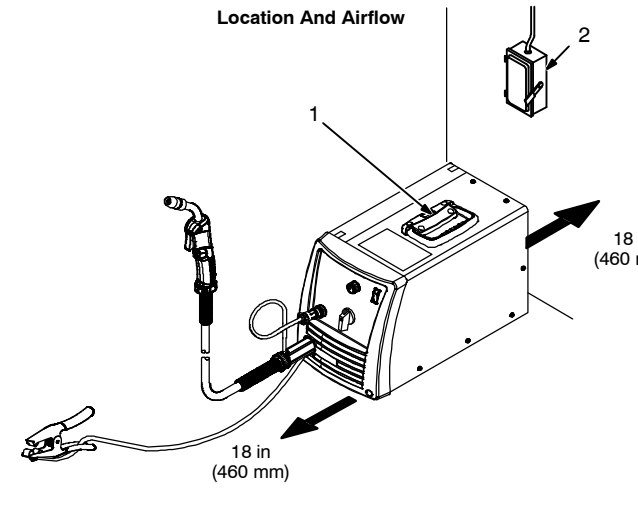

**⚠ Do not move or operate unit where it could tip.**



**⚠ Special installation may be required where gasoline or volatile liquids are present – see NEC Article 511 or CEC Section 20.**

- 1 Lifting Handle  
Use handle to lift unit.
- 2 Line Disconnect Device  
Locate unit near correct input power supply.

Loc\_handler 2018-04 161-122

### 5-2. Installing Nozzle, Contact Tip, And Adapter



**Tools Needed:**

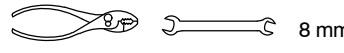

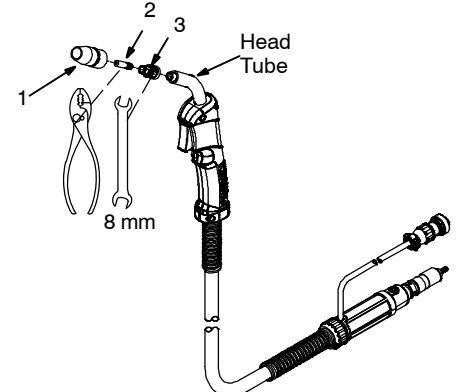

**⚠ Turn off welding power source.**

- 1 Nozzle
- 2 Contact Tip
- 3 Tip Adapter

*☞ Wire size stamped on tip – check and match wire size.*

Ref. 243 839-A

### 5-3. Installing Work Clamp



**☞ Connection hardware must be tightened with proper tools. Do not just hand tighten hardware. A loose electrical connection will cause poor weld performance and excessive heating of the work clamp.**

**Tools Needed:**

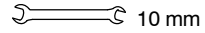

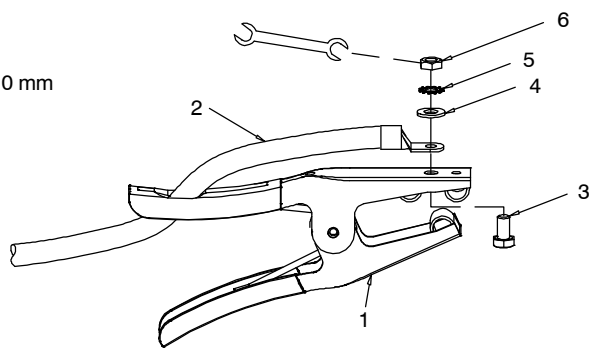

- 1 Work Clamp
- 2 Work Cable From Unit
- 3 Screw
- 4 Flat Washer
- 5 Lock Washer
- 6 Nut

Route work cable through hole in clamp handle. Secure cable with hardware as shown.

258 550-B

## 5-4. Installing Welding Gun

Be sure that gun end is tight against drive assembly.

**Incorrect Gun Not Seated**  
Exposed O-rings will cause shielding gas leakage.

**Correct Gun Fully Seated**

- 1 Drive Assembly
- 2 MIG Gun
- 3 Gun Securing Thumbscrew
- 4 Gun End

Loosen thumbscrew. Insert end through opening until it bottoms against drive assembly. Tighten thumbscrew.

Welding gun must be inserted completely to prevent leakage of shielding gas.

- 5 Gun Trigger Leads

Insert plug into receptacle, and tighten threaded collar.

- 6 Spool Gun/MIG Gun Switch

Place switch in MIG Gun position. Close door.

260 458-A

## 5-5. Process/Polarity Table

Process	Polarity	Cable Connections	
		Cable To Gun	Cable To Work
GMAW – Solid wire with shielding gas	DCEP – Reverse polarity	Connect to positive (+) output terminal	Connect to negative (-) output terminal
FCAW – Self-shielding wire – no shielding gas	DCEN – Straight Polarity	Connect to negative (-) output terminal	Connect to positive (+) output terminal

## 5-6. Changing Polarity

**CHANGING POLARITY**

**DCEN**  
Electrode negative for flux cored wire

**DCEP**  
Electrode positive for solid wire

**⚠ Turn off welding power source.**

- 1 Lead Connections For Direct Current Electrode Negative (DCEN)
- 2 Lead Connections For Direct Current Electrode Positive (DCEP)

Always read and follow wire manufacturer's recommended polarity, and see Section 5-5. Close door.

260 459-A

## 5-7. Installing Gas Supply



**DO NOT** use Argon/Mixed gas regulator/flowmeter with CO<sub>2</sub> shielding gas. See Accessories/Consumables for optional CO<sub>2</sub> gas regulator/flowmeter.

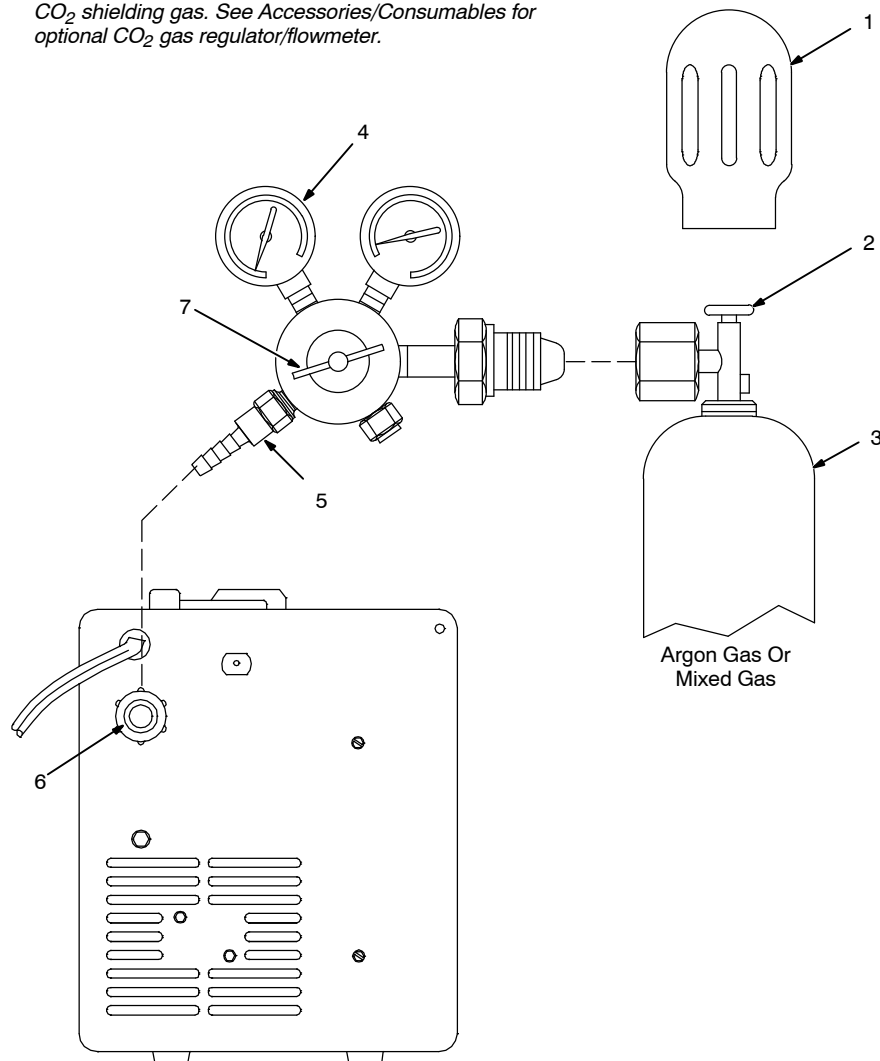

Obtain gas cylinder and chain to running gear, wall, or other stationary support so cylinder cannot fall and break off valve.

- 1 Cap
- 2 Cylinder Valve

Remove cap, stand to side of valve, and open valve slightly. Gas flow blows dust and dirt from valve. Close valve.

- 3 Cylinder
- 4 Regulator/Flowmeter

Install so face is vertical.

- 5 Regulator/Flowmeter Gas Hose Connection
- 6 Welding Power Source Gas Hose Connection

Connect supplied gas hose between regulator/flowmeter gas hose connection, and fitting on rear of welding power source.

- 7 Flow Adjust

Flow rate should be set when gas is flowing through welding power source and welding gun. Open pressure assembly so that wire will not feed. Press gun trigger to start gas flow.

**Typical flow rate is 20 cfh (cubic feet per hour). Check wire manufacturer's recommended flow rate.**

After flow is set, close pressure assembly.

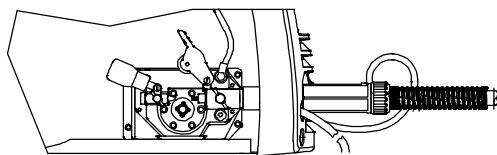

**Pressure Assembly Open**

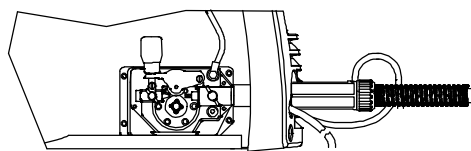

**Pressure Assembly Closed**

Tools Needed:

 5/8 or 11/16, 1-1/8 in.

## 5-8. Electrical Service Guide

**⚠** Failure to follow these electrical service guide recommendations could create an electric shock or fire hazard. These recommendations are for a dedicated circuit sized for the rated output and duty cycle of the welding power source.

In dedicated circuit installations, the National Electrical Code (NEC) allows the receptacle or conductor rating to be less than the rating of the circuit protection device. All components of the circuit must be physically compatible. See NEC articles 210.21, 630.11, and 630.12.

	60 Hz Single Phase	
<b>Input Voltage (V)</b>	230 Volts AC	115 Volts AC
<b>Input Amperes (A) At Rated Output</b>	24	A 20 ampere individual branch circuit protected by time-delay fuses or circuit breaker is required. See Section 4-3
<b>Max Recommended Standard Fuse Rating In Amperes</b> <sup>1</sup>		
<b>Time-Delay Fuses</b> <sup>2</sup>	30	
<b>Normal Operating Fuses</b> <sup>3</sup>	35	
<b>Min Input Conductor Size In AWG</b> <sup>4</sup>	14	
<b>Max Recommended Input Conductor Length In Feet (Meters)</b>	53 (16)	
<b>Min Grounding Conductor Size In AWG</b> <sup>4</sup>	14	

Reference: 2014 National Electrical Code (NEC) (including article 630)

- 1 If a circuit breaker is used in place of a fuse, choose a circuit breaker with time-current curves comparable to the recommended fuse.
- 2 "Time-Delay" fuses are UL class "RK5" . See UL 248.
- 3 "Normal Operating" (general purpose - no intentional delay) fuses are UL class "K5" (up to and including 60 amps), and UL class "H" ( 65 amps and above).
- 4 Conductor data in this section specifies conductor size (excluding flexible cord or cable) between the panelboard and the equipment per NEC Table 310.15(B)(16). If a flexible cord or cable is used, minimum conductor size may increase. See NEC Table 400.5(A) for flexible cord and cable requirements.

## 5-9. Extension Cord Data (Use Shortest Cord Possible)

*⚠* When calculating max. cord length, remember to include conductor length from line disconnect device to input power receptacle.

Input Voltage	Input Power Phase	Hertz	Conductor Size	Max. Cord Length
115 V	1	60	14 AWG	25 ft (8 m)
115 V	1	60	12 AWG	55 ft (17 m)
115 V	1	60	10 AWG	100 ft (30 m)
230 V	1	60	14 AWG	53 ft (16 m)

## 5-10. Multi-Voltage Plug (MVP) Connection

### Selecting Plug

**⚠ Do not cut off power cord connector and rewire. The power cord connector and plugs will work with standard NEMA receptacles. Modifying power cord, connector, and plugs will void product warranty.**

### Connecting Plug To Power Cord

#### Selecting Plug

1 Power Cord Connector From Welding Power Source

Select plug for power supply receptacle available at site. Not all plugs shown are provided as standard with unit.

2 Plug – NEMA Type 5–15P

3 Receptacle – NEMA Type 5–15R (Customer Supplied)

4 Plug – NEMA Type 5–20P (Optional)

5 Receptacle – NEMA Type 5–20R (Customer Supplied)

6 Plug – NEMA Type 6–50P

7 Receptacle – NEMA Type 6–50R (Customer Supplied)

**⚠ Follow electrical service guide for 230 VAC in Section 5-8. Do not use plug rating to size branch circuit protection.**

#### Connecting Plug To Power Cord

Align arrow on plug with arrow on power cord connector. Push together.

Tighten threaded collar. As threaded collar is tightened, push plug onto adapter until collar is completely tight.

Connect plug to receptacle.

MVP Plug1 2012-03 / Ref. 803 812-C

## 5-11. Connecting Input Power

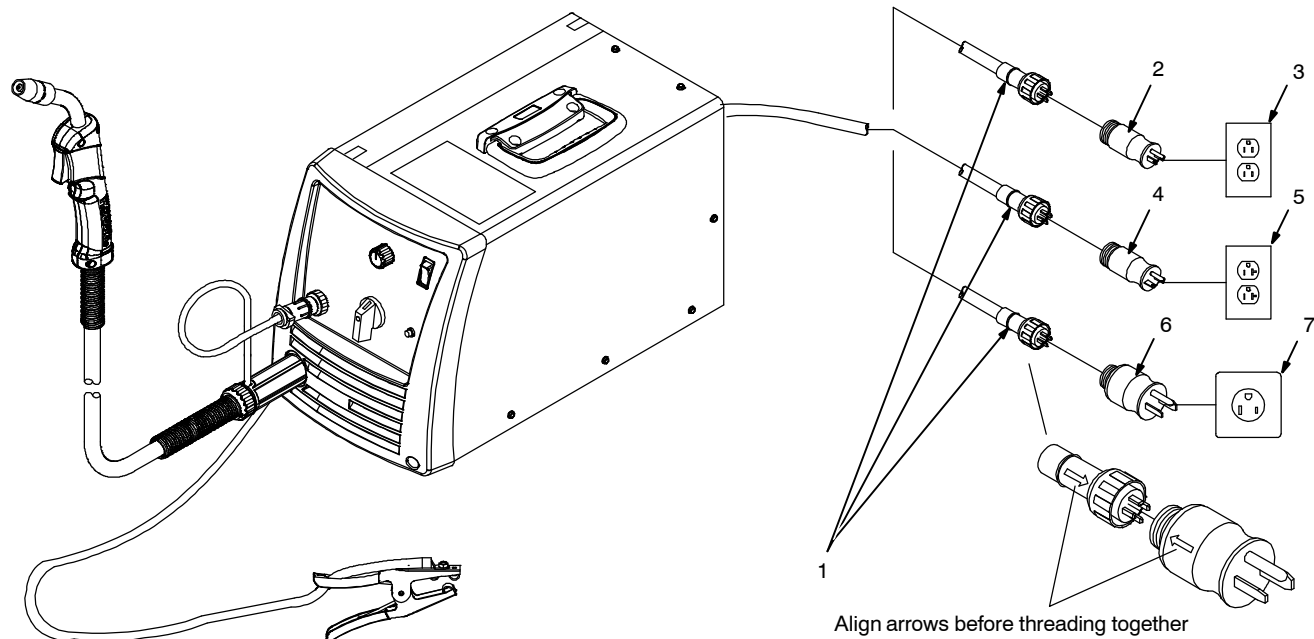

250 332-B

**⚠ Do Not modify or rewire receptacle connection.**

**⚠ Do Not cut off power cord connector and rewire. The power cord connector and plugs will work with standard NEMA receptacles. Modifying power cord, connector, and plugs will void product warranty.**

**⚠ Special installation may be required where gasoline or volatile liquids are present – see NEC Article 511 or CEC Section 20.**

Supply correct input power (see Section 4-1).

For 115 VAC input power, a 20 ampere individual branch circuit protected by time-delay fuses or circuit breaker is required, see Section 5-13. For 230 VAC input power, see Section 5-12.

- 1 Power Cord Connector
- 2 Plug – NEMA Type 5-15P
- 3 Receptacle – NEMA Type 5-15R (Customer Supplied)
- 4 Plug – NEMA Type 5-20P (Optional)

5 Receptacle NEMA Type 5-20R (Customer Supplied)

6 Plug – NEMA Type 6-50P

7 Receptacle – NEMA Type 6-50R (Customer Supplied)

Select plug for power supply receptacle available at site. Install plug onto power cord adapter. As threaded collar is tightened, push plug onto adapter until collar is completely tight.

Connect plug to receptacle.

## 5-12. Connecting 1-Phase Input Power For 230 VAC Input



Tools Needed:

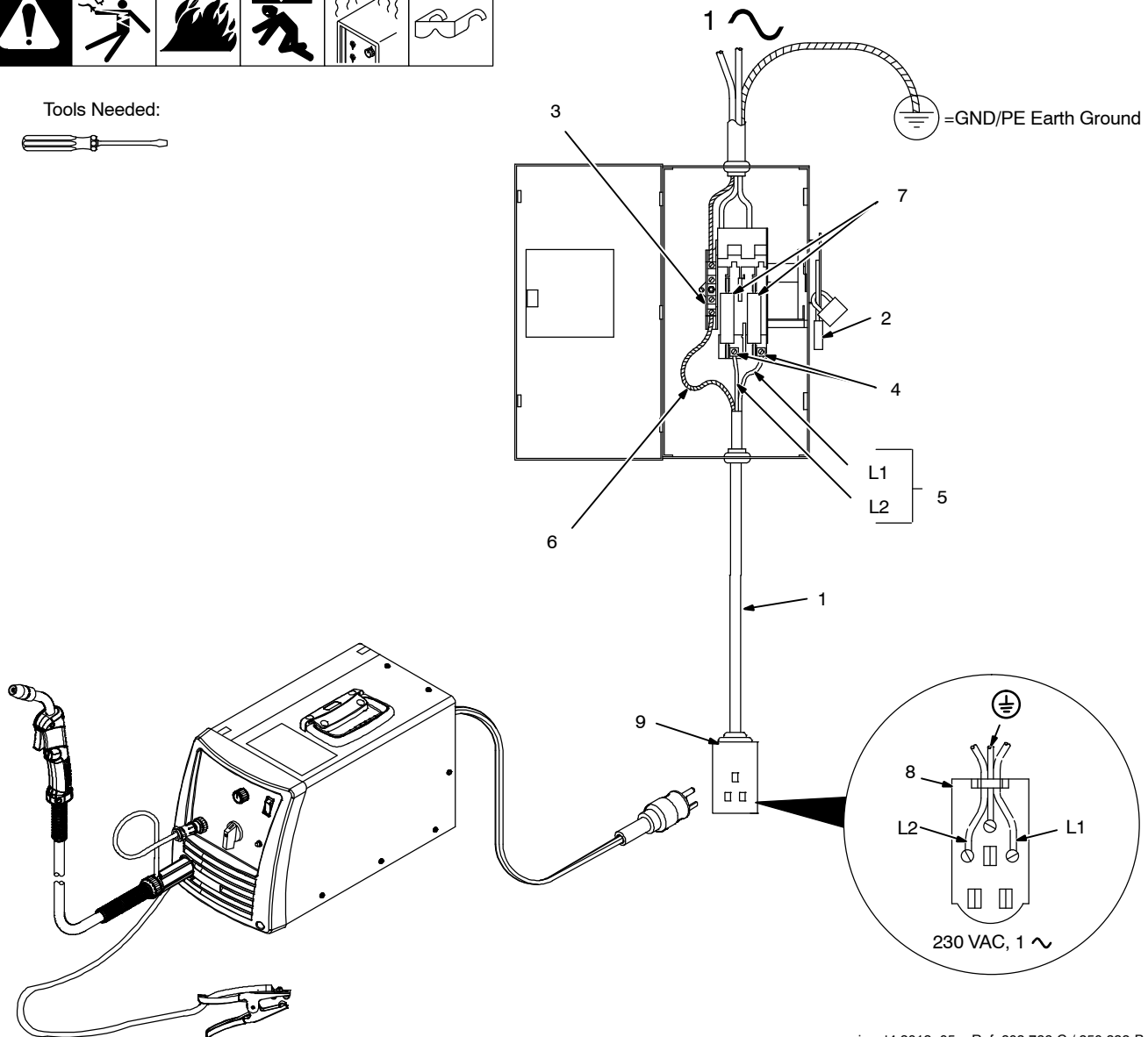

input4 2012-05 - Ref. 803 766-C / 250 332-B

**⚠ Installation must meet all National and Local Codes – have only qualified persons make this installation.**

**⚠ Disconnect and lockout/tagout input power before connecting input conductors from unit. Follow established procedures regarding the installation and removal of lockout/tagout devices.**

**⚠ Always connect green or green/yellow conductor to supply grounding terminal first, and never to a line terminal.**

See rating label on unit and check input voltage available at site.

- 1 Input Power Cord
- 2 Disconnect Device (switch shown in the OFF position)
- 3 Disconnect Device Grounding Terminal
- 4 Disconnect Device Line Terminals
- 5 Black And White Input Conductor (L1 And L2)
- 6 Green Or Green/Yellow Grounding Conductor

Connect green or green/yellow grounding conductor to disconnect device grounding terminal first.

Connect input conductors L1 and L2 to disconnect device line terminals.

7 Over-Current Protection

Select type and size of over-current protection using Section 5-8 (fused disconnect switch shown).

8 Receptacle (NEMA 6-50R)

Connect receptacle as shown.

Close and secure door on disconnect device. Follow established lockout/tagout procedures to put unit in service.

9 Plug (NEMA 6-50P)

Connect plug to receptacle.

input4 2012-05 - 803 766-C / 260 711-A

### 5-13. Connecting 1-Phase Input Power For 115 VAC Input

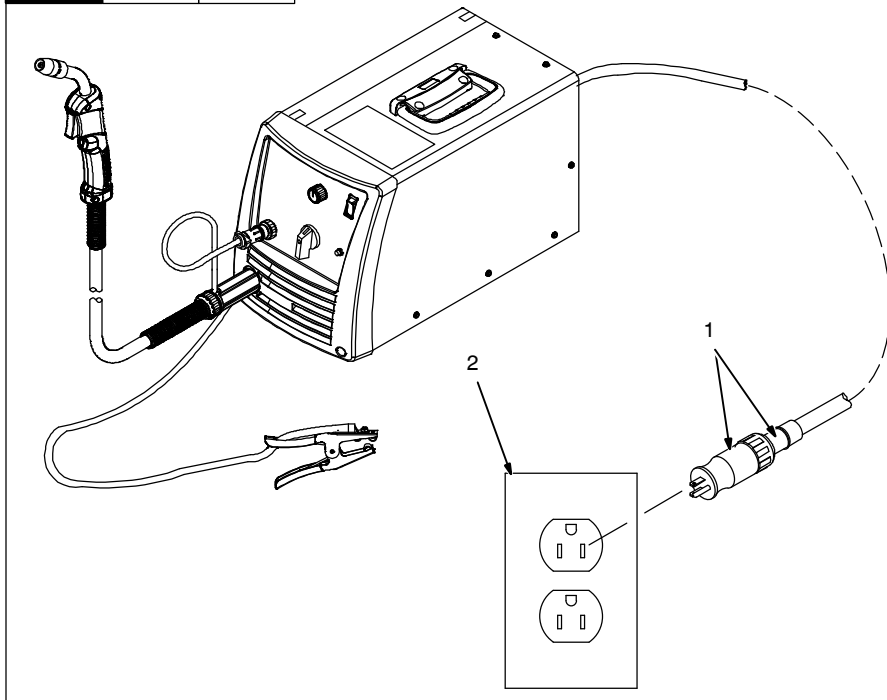

**⚠** Installation must meet all National and Local Codes – have only qualified persons make this installation.

**⚠** Always connect green or green/yellow conductor to supply grounding terminal first, and never to a line terminal.

For 115 volts AC input power, a 20 ampere individual branch circuit protected by time-delay fuses or circuit breaker is required.

1 Multi-Voltage Plug And Power Cord Connector (NEMA Type 5–15P Plug Shown)

For multi-voltage plug connections, see Section 5-11.

2 Receptacle – NEMA Type 5–15R (Customer Supplied)

Ref. 250 332-B

### 5-14. Installing Wire Spool And Adjusting Hub Tension



#### Installing 4 in. (102 mm) Wire Spool

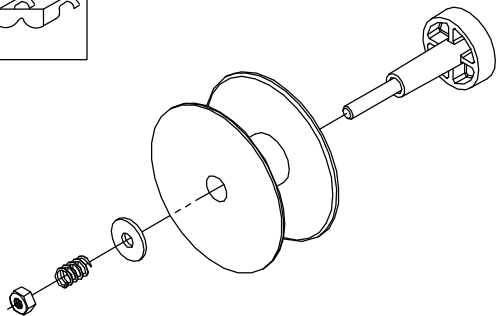

When a slight force is needed to turn spool, tension is set.

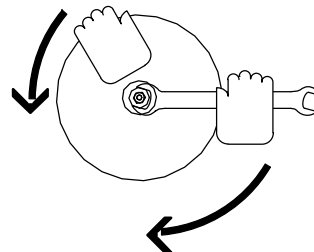

#### Installing 8 in. (203 mm) Wire Spool

Adapter used with 8 in. (203 mm) spool only.

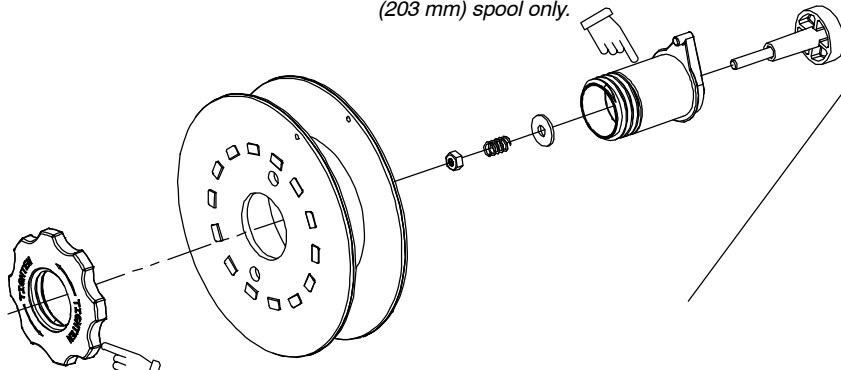

When a slight force is needed to turn spool, tension is set.

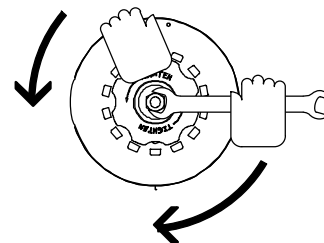

Retaining ring used with 8 in. (203 mm) spool only.

Tools Needed:



803 012 / 803 013 -B / Ref. 802 971-C

## 5-15. Connecting Optional Spool Gun

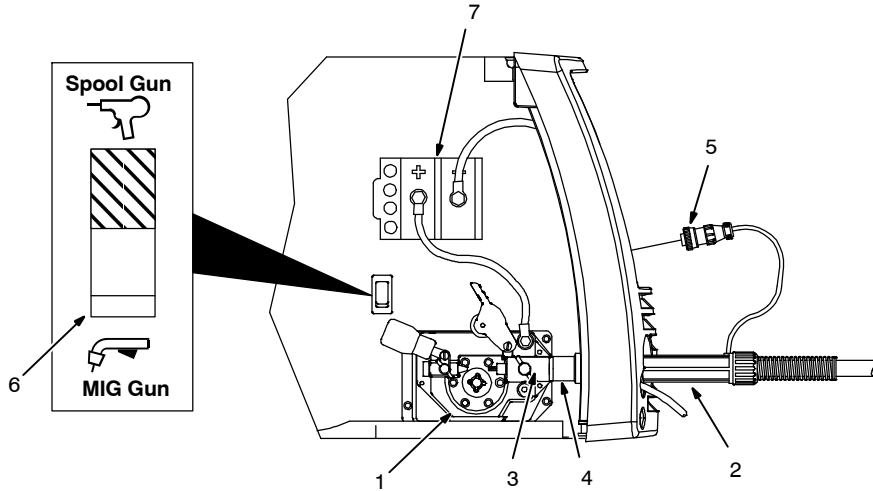

- 1 Drive Assembly
- 2 Spool Gun
- 3 Gun Securing Thumbscrew
- 4 Gun End

Loosen thumbscrew. Insert end through opening until it bottoms against drive assembly. Tighten thumbscrew.

Spool gun must be inserted completely to prevent leakage of shielding gas.

- 5 Gun Trigger Plug

Insert plug into receptacle, and tighten threaded collar.

- 6 Spool Gun/MIG Gun Switch

Place switch in Spool Gun position.

- 7 Polarity Changeover Terminal Block

To make proper polarity connection, see welding power source Owner's Manual.

Close door.

- 8 Wire Feed Speed Control

Wire feed speed is controlled by welding power source Wire Speed control (see welding power source Owner's Manual or door chart for appropriate setting).

- 9 Voltage Control

Arc voltage is controlled by welding power source Voltage control (see welding power source Owner's Manual or door chart for appropriate setting).

- 10 Trigger

Press trigger to energize welding power source contactor, start shielding gas flow, and begin wire feed.

Be sure that gun end is tight against drive assembly.

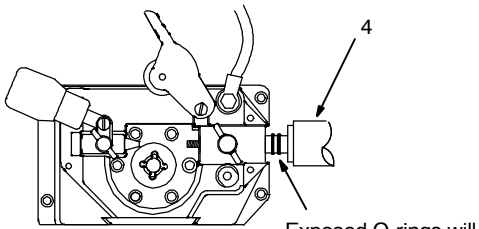

**Incorrect  
Gun Not Seated**

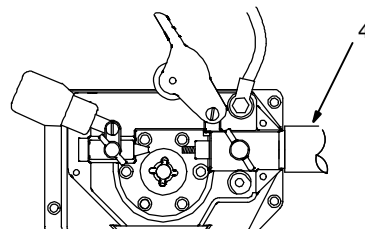

**Correct  
Gun Fully Seated**

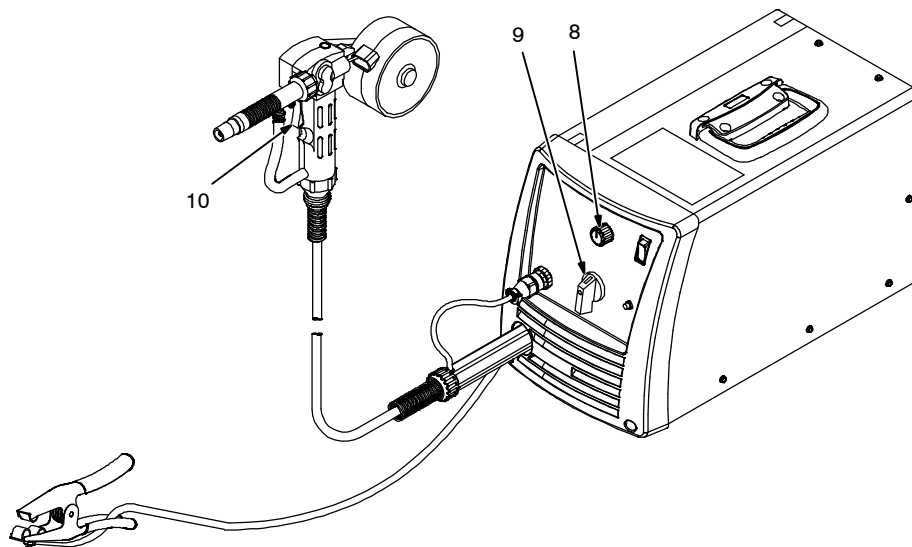

## 5-16. Threading Welding Wire



- 1 Wire Spool
  - 2 Welding Wire
  - 3 Inlet Wire Guide
  - 4 Pressure Adjustment Knob
  - 5 Drive Roll
  - 6 Gun Conduit Cable
- Lay gun cable out straight.

Tools Needed:

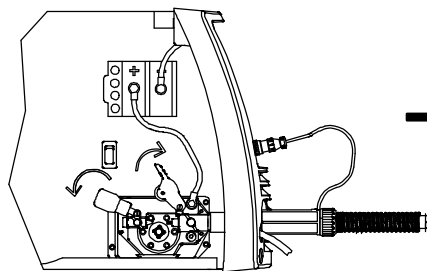
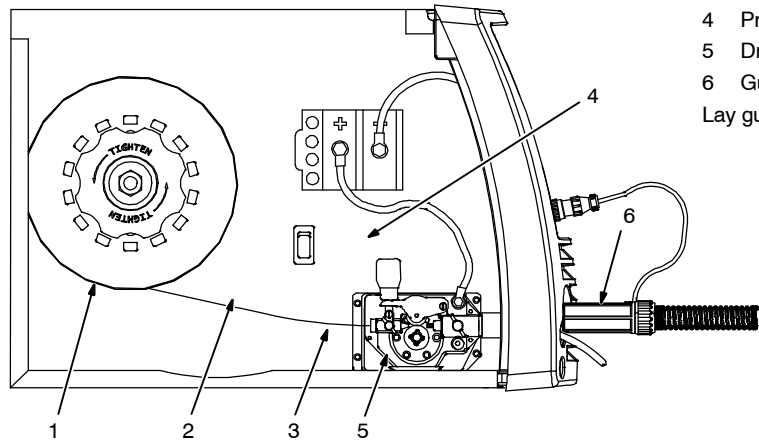
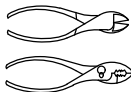

Open pressure assembly. Make sure feed roll is set to correct groove to match wire size (see Section 7-4).

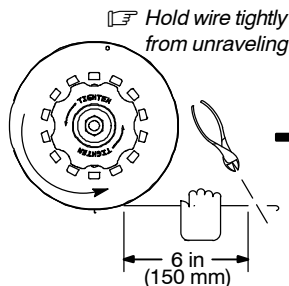

Pull and hold wire; cut off end.

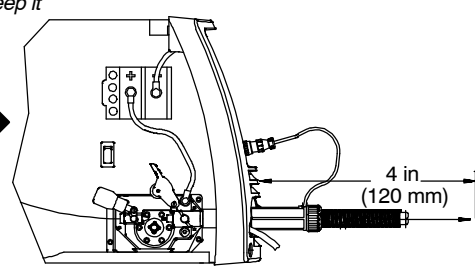

Push wire thru guides into gun; continue to hold wire.

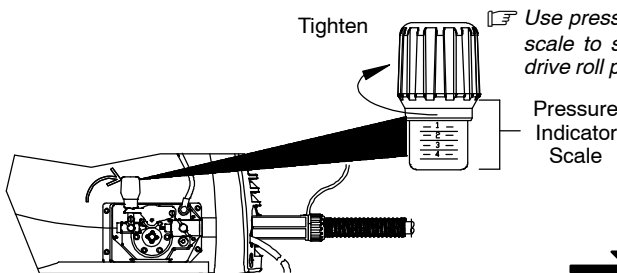

Be sure that wire is positioned in proper feed roll groove. Close and tighten pressure assembly, and let go of wire.

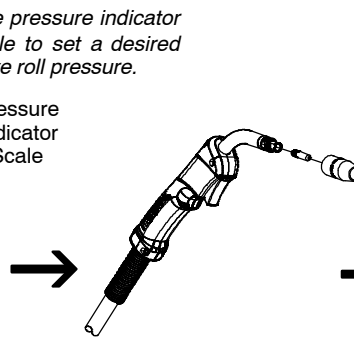

Remove gun nozzle and contact tip.

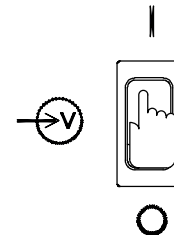

Turn power on. Be sure that Voltage range switch is set to range 1, 2, 3, 4, 5, 6, or 7 to feed wire. Rotate knob until it "clicks" into detent. Wire will not feed if range switch is set between ranges.

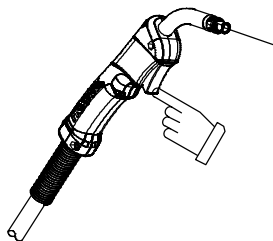

Press gun trigger until wire comes out of gun.

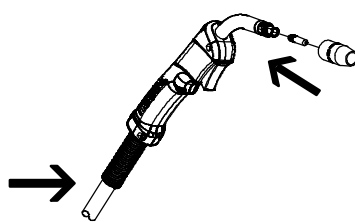

Be sure that tip matches wire diameter. Reinstall contact tip and nozzle.

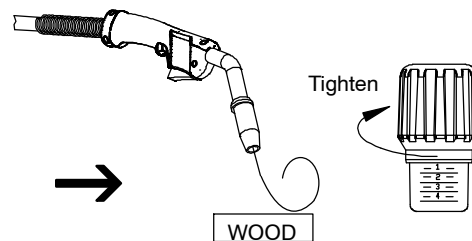

Feed wire to check drive roll pressure. Tighten knob enough to prevent slipping. Cut off wire. Close door.

# SECTION 6 – OPERATION

## 6-1. Controls

**1 Wire Speed Control**  
Control varies the rate of wire being fed through the welding gun.

**2 Power Switch/Supplementary Protector**  
Turns power on and off. Also, this switch functions as supplementary protector CB1. CB1 protects unit from overload. If CB1 opens, unit shuts down.

**3 Voltage Control**  
Control varies the voltage level of the welding arc. The voltage range is 4 (minimum) to 7 (maximum) on 115 VAC and 1 (minimum) to 7 (maximum) on 230 VAC.

**4 Over Temperature Light**  
Light illuminates if main transformer overheats.

**5 Gun Trigger Receptacle**

**6 Trigger Switch**  
When pressed, energizes wire feed motor and gas valve for shielding gas flow.

**Reset power switch/supplementary protector.**

**DO NOT SWITCH WHILE WELDING**

**Switch must "click" into detent position. DO NOT switch under load.**

250 650-A

## 6-2. Weld Parameter Chart

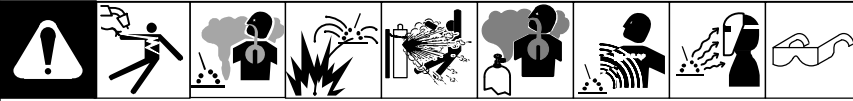

# Welding Guide for 115/230 Volt Wire Welding Package

Settings are approximate. Adjust as required. Thicker materials can be welded using proper technique, joint preparation and multiple passes.

Recommended Voltage and Wire Speed Settings for thickness of metal being welded. Number on left of slash is Voltage Setting / Number on right of slash is Wire Feed Setting.

Material Being Welded	Wire Type and Polarity Setting	Suggested Shielding Gas 20-30 cfm Flow Rate	Input Voltage	Diameter of Wire Being Used	24 ga. .024 in. (0.6 mm)	22 ga. .030 in. (0.8 mm)	18 ga. .048 in. (1.2 mm)	16 ga. .060 in. (1.5 mm)	11 ga. 1/8 Inch (3.2 mm)	3/16 Inch (4.8 mm)	1/4 Inch (6.4 mm)	3/8 Inch (9.5 mm)	CHANGING POLARITY
Steel	Solid Wire ERT/OS-6 "Set Polarity for (DCEP)"	C <sub>2</sub> Gas Mixture 75% Argon/25% CO <sub>2</sub> Produces Less Spatter Better Appearance	230 V	.024" (0.6mm)	1 / 20	2 / 25	3 / 40	3 / 50	5 / 70	6 / 80	~	~	DCEN Electrode Negative For Flux Cored Wire
				.030" (0.8mm)	2 / 20	2 / 25	3 / 25	3 / 30	4 / 40	5 / 50	6 / 60	6 / 70*	
			.024" (0.6mm)	4 / 25	5 / 30	6 / 40	6 / 45	7 / 65	~	~	~	~	DCEP Electrode Positive For Solid Wire
			.030" (0.8mm)	5 / 15	5 / 20	6 / 25	6 / 30	7 / 50	~	~	~	~	
			.035" (0.9mm)	~	~	6 / 20	6 / 25	7 / 30	~	~	~	~	
			.040" (0.9mm)	~	~	3 / 30	4 / 40	5 / 65	5 / 70	~	~	~	
Stainless Steel	Stainless Steel "Set Polarity for (DCEP)"	100% CO <sub>2</sub>	230 V	.030" (0.8mm)	~	~	3 / 30	4 / 30	5 / 40	6 / 40	6 / 50	~	DCEP Electrode Positive For Solid Wire
				.035" (0.9mm)	~	~	3 / 20	3 / 25	5 / 35	6 / 35	7 / 40	7 / 45*	
			.024" (0.6mm)	~	~	5 / 25	6 / 35	7 / 50	~	~	~	~	DCEP Electrode Positive For Solid Wire
			.030" (0.8mm)	~	~	~	6 / 25	7 / 35	~	~	~	~	
			.035" (0.9mm)	~	~	~	6 / 20	7 / 25	~	~	~	~	
			.040" (0.9mm)	~	~	3 / 35	4 / 40	6 / 70	~	~	~	~	
Steel	Flux Core E71T-11 "Set Polarity for (DCEP)"	No Shielding Gas Required Good for Windy or Outdoor Applications	230 V	.030" (0.8mm)	~	~	3 / 20	4 / 30	6 / 50	7 / 70	~	~	DCEP Electrode Positive For Solid Wire
				.035" (0.9mm)	~	~	3 / 20	4 / 25	6 / 50	7 / 50	~	~	
			.024" (0.6mm)	~	~	5 / 30	6 / 30	7 / 40	~	~	~	~	DCEP Electrode Positive For Solid Wire
			.030" (0.8mm)	~	~	5 / 20	6 / 25	7 / 35	~	~	~	~	
			.035" (0.9mm)	~	~	~	~	~	~	~	~	~	
			.040" (0.9mm)	~	~	1 / 20	2 / 25	4 / 45	5 / 45	5 / 50	~	~	
Aluminum with Optional SpoolRunner™ 100 Spool Gun	Aluminum** 4043 AL "Set Polarity for (DCEP)" Aluminum** 5356 AL "Set Polarity for (DCEP)"	100% Argon**	230 V	.030" (0.8mm)	~	~	1 / 15	2 / 20	4 / 35	5 / 35	6 / 45	7 / 50*	DCEP Electrode Positive For Solid Wire
				.035" (0.9mm)	~	~	1 / 10	4 / 15	4 / 20	5 / 25	6 / 30*	~	
			.030" (0.8mm)	~	~	4 / 20	5 / 25	7 / 40	7 / 45	~	~	~	DCEP Electrode Positive For Solid Wire
			.035" (0.9mm)	~	~	4 / 10	4 / 15	6 / 20	7 / 30	7 / 35	~	~	
			.040" (0.9mm)	~	~	2 / 60	3 / 65	5 / 70	6 / 85	7 / 100	~	~	
			.045" (1.1mm)	~	~	4 / 60	5 / 70	7 / 80	~	~	~	~	
Aluminum with Optional SpoolRunner™ 100 Spool Gun	Aluminum** 5356 AL "Set Polarity for (DCEP)"	100% Argon**	230 V	.030" (0.8mm)	~	~	2 / 70	3 / 75	5 / 90	6 / 100	6 / 100	~	DCEP Electrode Positive For Solid Wire
				.035" (0.9mm)	~	~	~	~	5 / 90	6 / 90	7 / 100	~	
Aluminum with Optional SpoolRunner™ 100 Spool Gun	Aluminum** 5356 AL "Set Polarity for (DCEP)"	100% Argon**	115 V	.030" (0.8mm)	~	~	4 / 70	5 / 75	7 / 90	~	~	~	DCEP Electrode Positive For Solid Wire
				.035" (0.9mm)	~	~	~	~	~	~	~	~	

**CAUTION!** Do not change Voltage switch position while welding. See Owner's Manual for more information.

Wire Speed listed is a starting value only. Wire Speed setting can be fine-tuned while welding. Wire Speed also depends on other variables, such as stick out, travel speed, weld angle, cleanliness of metal, etc.

\* Multiple passes may be required depending on the application and joint design.  
 \*\* Aluminum wire settings are with the SpoolRunner™ 100 Spool Gun attached. A spool gun eliminates many feasibility issues associated with the soft aluminum wire. A "push angle" for the torch is normally recommended for aluminum.

250015-B



### 7-3. Drive Motor Protection

Drive motor protection circuit protects drive motor from overload. If drive motor becomes inoperative, release gun trigger and wait until protection circuit resets allowing drive motor to feed wire again.

### 7-4. Changing Drive Roll Or Wire Inlet Guide

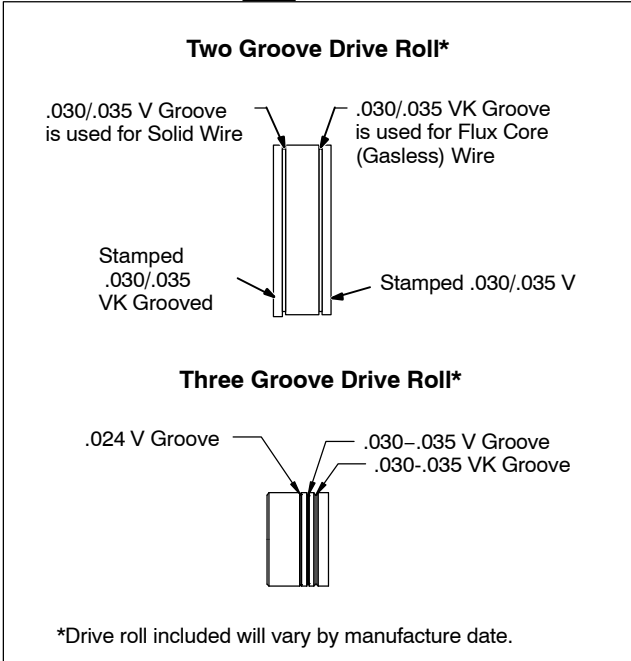
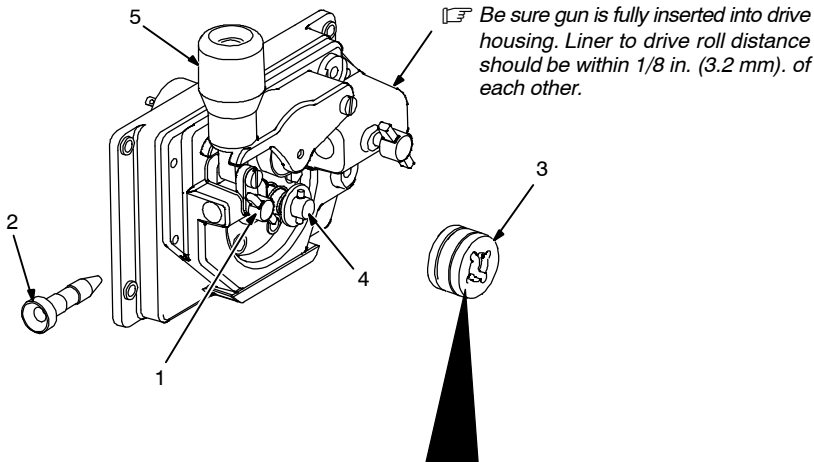

1 Inlet Wire Guide Securing Screw

2 Inlet Wire Guide

Loosen thumbscrew. Slide tip as close to drive rolls as possible without touching. Tighten thumbscrew.

3 Two Or Three Groove Drive Roll

*Unit comes with one drive roll. Drive roll included will vary by manufacture date.*

Two Groove drive rolls have two different size grooves. When installed, the groove size that can be read on the face of the drive roll is the size of the groove that is lined up for use.

Three Groove drive rolls have three different size grooves. The text aligned with the drive roll retaining pin indicates the selected groove.

*VK (Knurled) groove is used for flux cored wire and V groove is used for solid wire.*

4 Retaining Pin

To secure drive roll, locate open slot and push drive roll completely over retaining pin, then rotate drive roll (1/4 turn) to closed slot.

5 Drive Roll Tension Knob

Using flux core wire with VK groove, tension should be set between 1-1/2 to 2. Higher setting may cause welding wire to deform and not allow proper feeding.

Flux Core Wire – Recommended stickout is 1/2 in. (12.7 mm) from gun tip.

Solid Wire – Recommended stickout is 3/8 in. (9.5 mm) from gun tip.

**Actual drive roll may differ from that shown. See Section 10-2 for additional drive roll configurations.**

## 7-5. Changing Nozzle, Contact Tip, Adapter And Liner, And Cleaning Gun Casing



**⚠ Turn off welding power source.**

- 1 Nozzle
- 2 Contact Tip
- 3 Tip Adapter

**📏 Wire size stamped on tip – check and match wire size.**

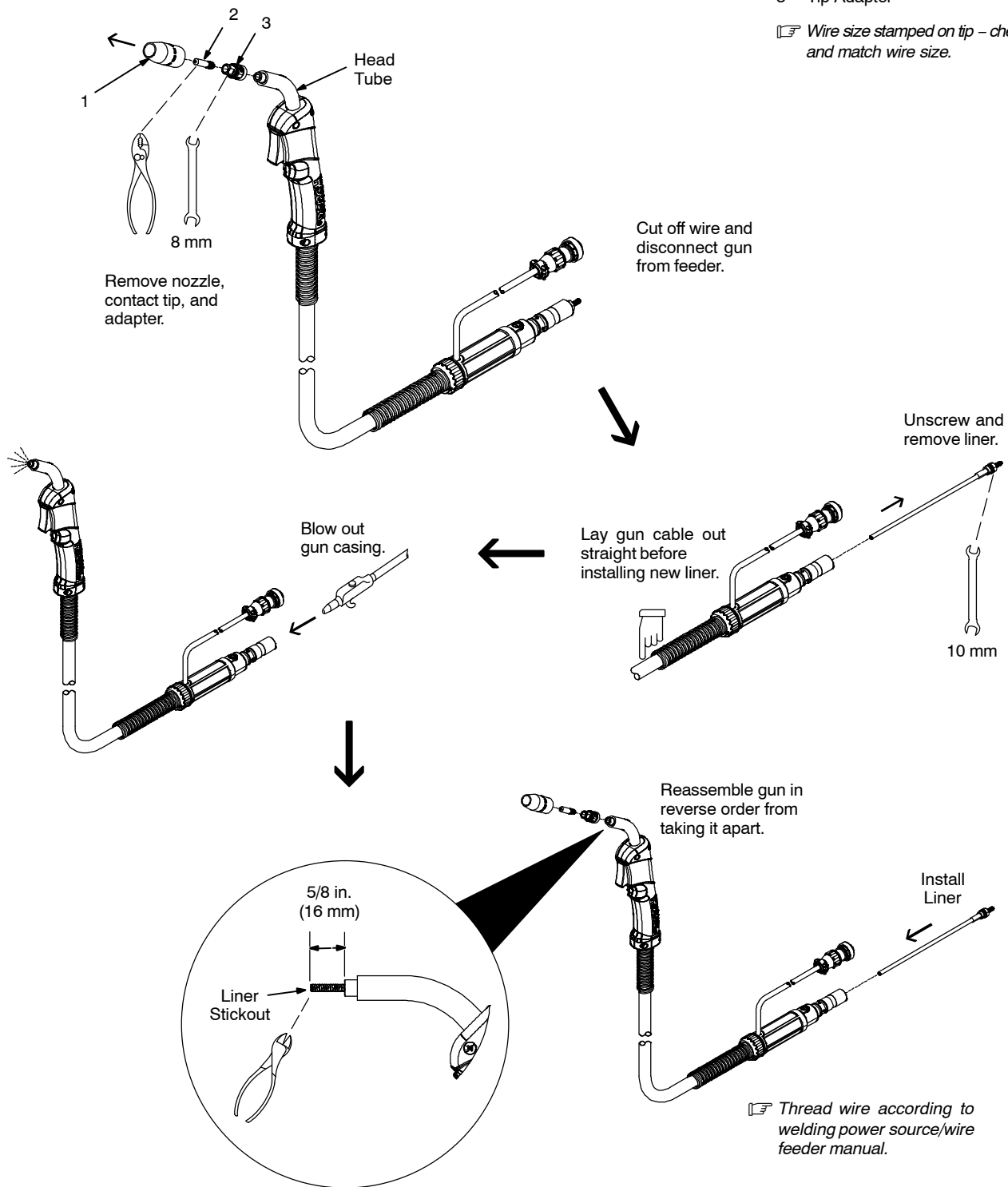

Tools Needed:

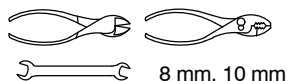

8 mm, 10 mm

## 7-6. Replacing Switch And/Or Head Tube



**Turn Off welding power source /wire feeder and disconnect gun.**

1 Remove screws (5) and nuts (4).

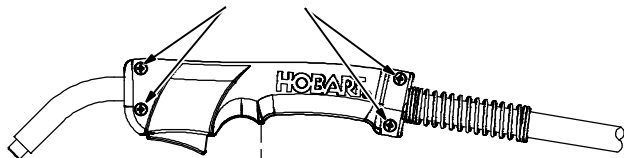

Remove screw on opposite side.

2 Remove handle halves.

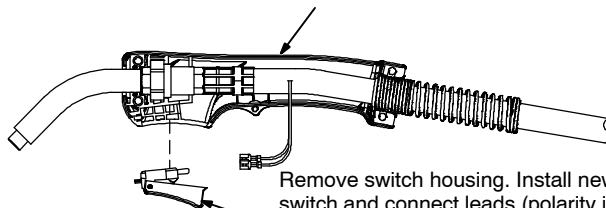

Remove switch housing. Install new switch and connect leads (polarity is not important). Reassemble in reverse order. If replacing head tube, continue to end of figure.

3

4 Secure head tube in vice.

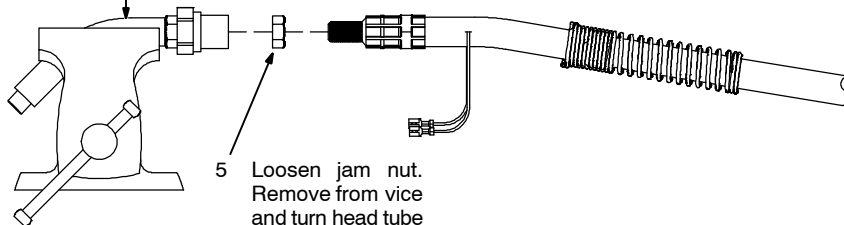

5 Loosen jam nut. Remove from vice and turn head tube out by hand.

6 Hand-tighten head tube into cable connector.

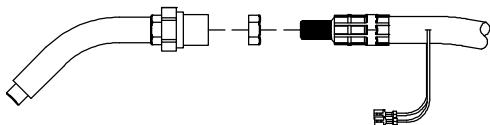

7 Place head tube in vice and tighten until nuts are tight.

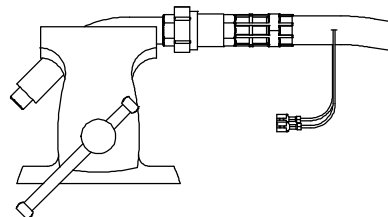

8 Remove from vice. Reposition handle halves, and install switch housing.

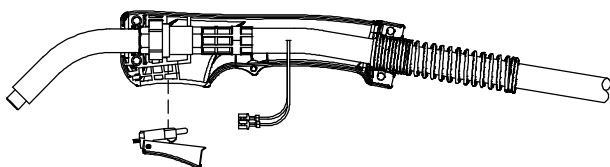

9 Reinstall screws and nuts.

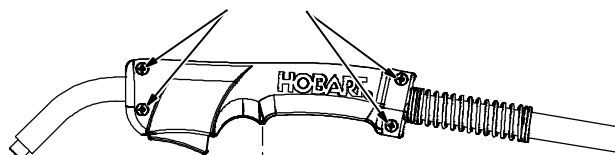

Reinstall screw on opposite side.

Tools Needed:



phillips

15 mm

## 7-7. Troubleshooting Table



Trouble	Remedy
No weld output; wire does not feed; fan does not run.	Secure power cord plug in receptacle (see Section 5-11).
	Replace building line fuse or reset circuit breaker if open.
	Place Power switch in On position (see Section 6-1).
	Reset welding power source supplementary protector (see Section 7-2).
No weld output; wire does not feed; fan motor continues to run.	Thermostat TP1 open (overheating). Allow fan to run with gun trigger switch off; thermostat closes when unit has cooled (see Section 4-4).
	Check Voltage range switch position. Rotate knob until it “clicks” into detent at desired range setting.
	Secure gun trigger leads (see Section 5-4).
No weld output; wire feeds.	Connect work clamp to get good metal to metal contact.
	Replace contact tip (see Section 7-5).
	Check for proper polarity connections (see Section 5-6).
	Check thumbscrew securing gun end to feed head adapter and tighten if necessary.
Wire does not feed; wire is not energized; wire feeds unevenly.	Check contact tip. Check for kinks in gun cable and liner.
	Check gun trigger plug connection at welding power source/wire feeder.
	Check, and if necessary, replace gun trigger switch (see Section 7-6).
	Check contact tip. Check for kinks in gun cable. Blow out liner and gun casing (see Section 7-5).
Low weld output.	Connect unit to proper input voltage or check for low line voltage.
	Place voltage switch in desired position (see Section 6-1).
Electrode wire feeding stops during welding.	Straighten gun cable and/or replace damaged parts.
	Adjust drive roll pressure (see Section 5-16).
	Change to proper drive roll groove (see Section 7-4).
	Readjust hub tension (see Section 5-14).
	Replace contact tip if blocked (see Section 7-5).
	Clean or replace wire inlet guide or liner if dirty or plugged (see Section 7-4 or Section 7-5).
	Replace drive roll or pressure bearing if worn or slipping (see Section 7-4).
	Secure gun trigger leads or repair leads (see Section 5-4).
	Check and clear any restrictions at drive assembly and liner (see Section 7-4 or Section 7-5).
	Gun is not secured to feed head. Check thumbscrew securing gun end to feed head adapter and tighten if necessary.
Weld porosity.	Remove weld spatter buildup in nozzle.
	Check O-rings on gun connector and replace if damaged.
	Make sure inner head tube is tight in cable connector.
	Check gun connector to be sure it is fully inserted into drive assembly.
	Check shielding gas flow/supply.
	Check for proper output polarity (see Section 5-6)

# SECTION 8 - ELECTRICAL DIAGRAM

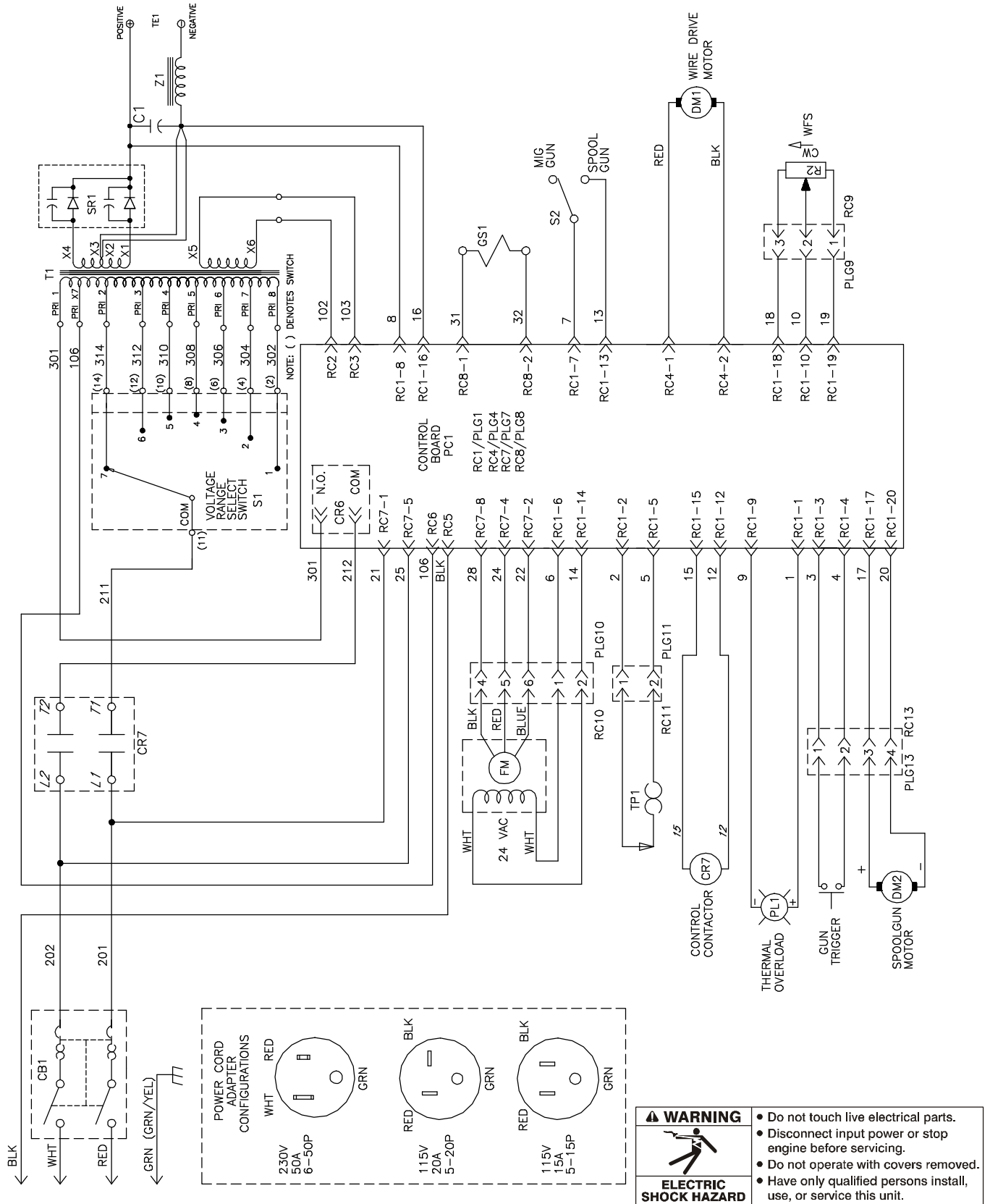
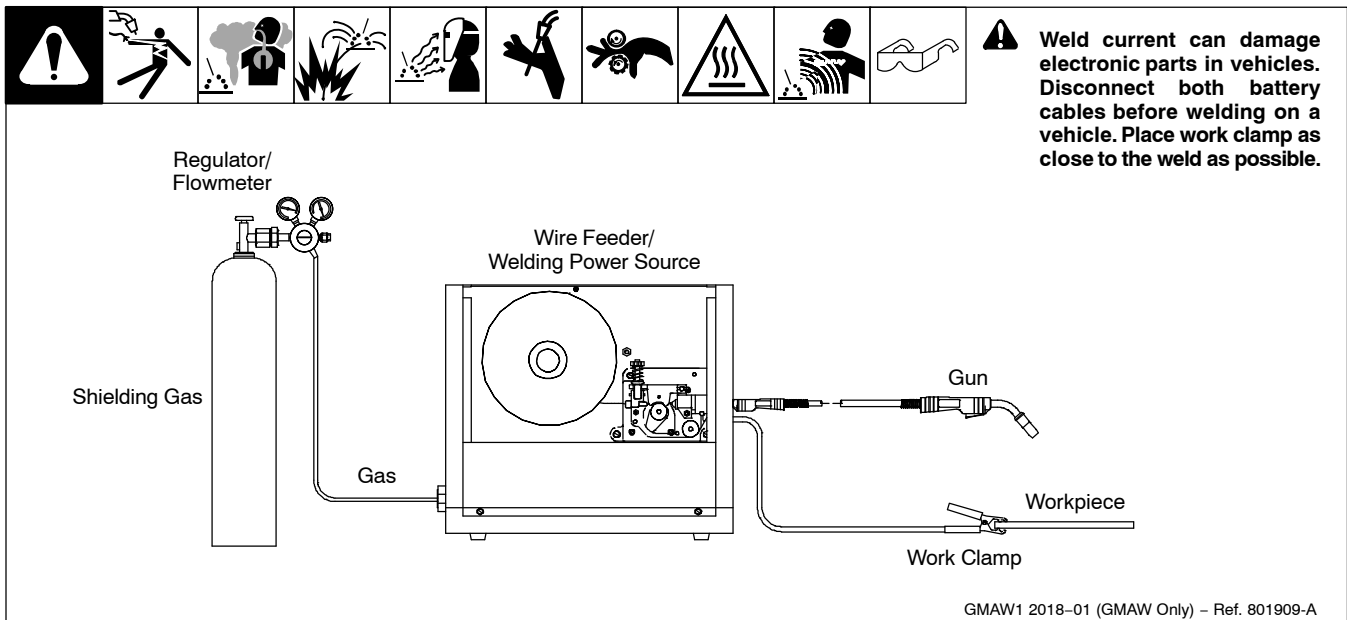

Figure 8-1. Circuit Diagram

# SECTION 9 – GMAW WELDING (MIG) GUIDELINES

## 9-1. Typical GMAW (MIG) Process Connections



## 9-2. Typical GMAW (MIG) Process Control Settings

1 Material Thickness  
Material thickness determines weld parameters.  
Convert material thickness to amperage (A):  
0.001 in. (0.025 mm) = 1 ampere  
0.0625 in. (1.59 mm) ÷ 0.001 = 62.5 A

2 Select Wire Size  
See table below.

3 Select Wire Feed Speed (Amperage)  
Wire feed speed (amperage) controls weld penetration.  
See table below.

4 Select Voltage  
Voltage controls height and width of weld bead.  
Low Voltage: wire stubs into work  
High Voltage: arc is unstable (spatter)  
Set voltage midway between high and low voltage.

Wire Size	Amperage Range	Recommended Wire Feed Speed	Wire Feed Speed*
0.023 in. (0.58 mm)	30–90 A	3.5 in. (89 mm) per amp	3.5 x 62.5 A = 219 ipm (5.56 mpm)
0.030 in. (0.76 mm)	40–145 A	2 in. (51 mm) per amp	2 x 62.5 A = 125 ipm (3.19 mpm)
0.035 in. (0.89 mm)	50–180 A	1.6 in. (41 mm) per amp	1.6 x 62.5 A = 100 ipm (2.56 mpm)

\*62.5 A based on 1/16 in. (1.6 mm) material thickness.

ipm = inches per minute; mpm = meters per minute

### 9-3. Holding And Positioning Welding Gun



☞ *Welding wire is energized when gun trigger is pressed. Before lowering helmet and pressing trigger, be sure wire is no more than 1/2 in. (13 mm) past end of nozzle, and tip of wire is positioned correctly on seam.*

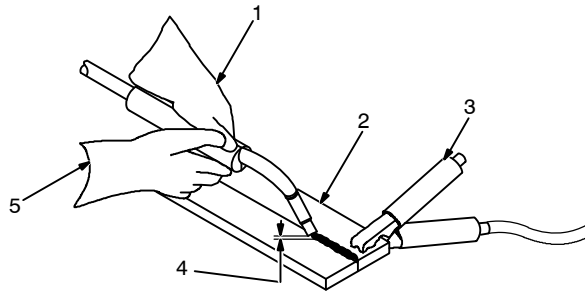

- 1 Hold Gun and Control Gun Trigger
- 2 Workpiece
- 3 Work Clamp
- 4 Electrode Extension (Stickout)  
Solid Wire – 3/8 to 1/2 in.  
(9 to 13 mm)
- 5 Cradle Gun and Rest Hand on Workpiece

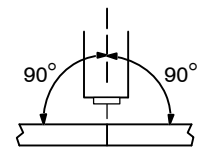

End View of Work Angle

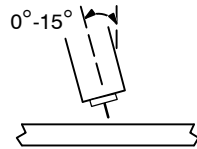

Side View of Gun Angle

Groove Welds

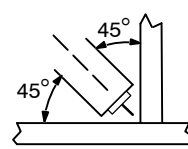

End View of Work Angle

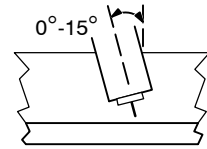

Side View of Gun Angle

Fillet Welds

S-0421-A

### 9-4. Conditions That Affect Weld Bead Shape

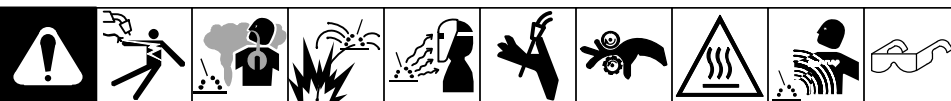

☞ *Weld bead shape depends on gun angle, direction of travel, electrode extension (stickout), travel speed, thickness of base metal, wire feed speed (weld current), and voltage.*

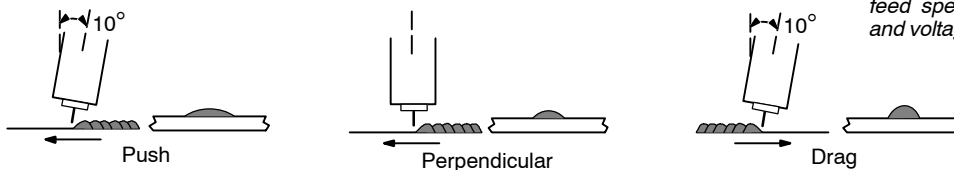

Gun Angles And Weld Bead Profiles

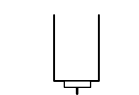

Short

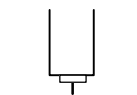

Normal

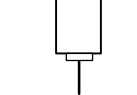

Long

Electrode Extensions (Stickout)

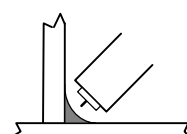

Short

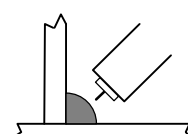

Normal

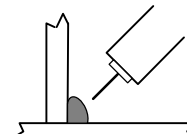

Long

Fillet Weld Electrode Extensions (Stickout)



Slow



Normal



Fast

Gun Travel Speed

S-0634

## 9-5. Gun Movement During Welding

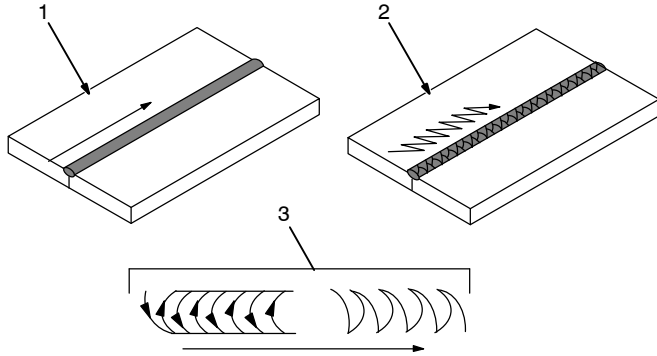

Normally, a single stringer bead is satisfactory for most narrow groove weld joints; however, for wide groove weld joints or bridging across gaps, a weave bead or multiple stringer beads works better.

- 1 Stringer Bead – Steady Movement Along Seam
- 2 Weave Bead – Side To Side Movement Along Seam
- 3 Weave Patterns

Use weave patterns to cover a wide area in one pass of the electrode.

S-0054-A

## 9-6. Poor Weld Bead Characteristics

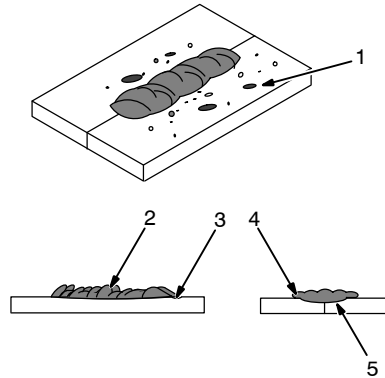

- 1 Large Spatter Deposits
- 2 Rough, Uneven Bead
- 3 Slight Crater During Welding
- 4 Bad Overlap
- 5 Poor Penetration

S-0053-A

## 9-7. Good Weld Bead Characteristics

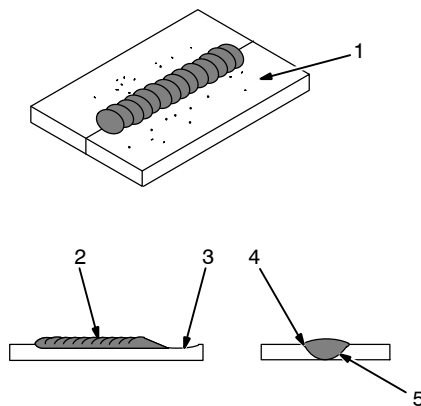

- 1 Fine Spatter
- 2 Uniform Bead
- 3 Moderate Crater During Welding

Weld a new bead or layer for each 1/8 in. (3.2 mm) thickness in metals being welded.

- 4 No Overlap
- 5 Good Penetration into Base Metal

S-0052-B

## 9-8. Troubleshooting – Excessive Spatter

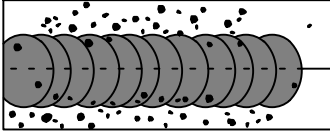

Excessive Spatter – scattering of molten metal particles that cool to solid form near weld bead.

S-0636

Possible Causes	Corrective Actions
Wire feed speed too high.	Select lower wire feed speed.
Voltage too high.	Select lower voltage range.
Electrode extension (stickout) too long.	Use shorter electrode extension (stickout).
Workpiece dirty.	Remove all grease, oil, moisture, rust, paint, undercoating, and dirt from work surface before welding.
Insufficient shielding gas at welding arc.	Increase flow of shielding gas at regulator/flowmeter and/or prevent drafts near welding arc.
Dirty welding wire.	Use clean, dry welding wire. Eliminate pickup of oil or lubricant on welding wire from feeder or liner.
Incorrect polarity.	Check polarity required by welding wire, and change to correct polarity at welding power source.

## 9-9. Troubleshooting – Porosity

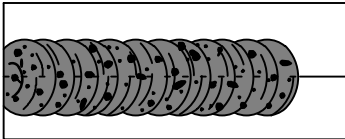

Porosity – small cavities or holes resulting from gas pockets in weld metal.

S-0635

Possible Causes	Corrective Actions
Insufficient shielding gas at welding arc.	Increase flow of shielding gas at regulator/flowmeter and/or prevent drafts near welding arc.
	Remove spatter from gun nozzle.
	Check gas hoses for leaks.
	Place nozzle 1/4 to 1/2 in. (6-13 mm) from workpiece.
	Hold gun near bead at end of weld until molten metal solidifies.
Wrong gas.	Use welding grade shielding gas; change to different gas.
Dirty welding wire.	Use clean, dry welding wire.
	Eliminate pick up of oil or lubricant on welding wire from feeder or liner.
Workpiece dirty.	Remove all grease, oil, moisture, rust, paint, coatings, and dirt from work surface before welding.
	Use a more highly deoxidizing welding wire (contact supplier).
Welding wire extends too far out of nozzle.	Be sure welding wire extends not more than 1/2 in. (13 mm) beyond nozzle.

## 9-10. Troubleshooting – Excessive Penetration

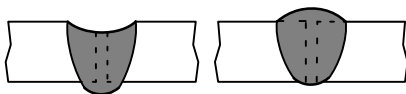

Excessive Penetration Good Penetration

Excessive Penetration – weld metal melting through base metal and hanging underneath weld.

S-0639

Possible Causes	Corrective Actions
Excessive heat input.	Select lower voltage range and reduce wire feed speed.
	Increase travel speed.

## 9-11. Troubleshooting – Lack Of Penetration

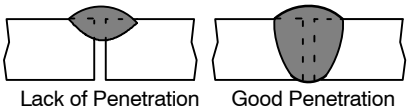
 <p>Lack of Penetration      Good Penetration</p>		Lack Of Penetration – shallow fusion between weld metal and base metal.
S-0638		
Possible Causes	Corrective Actions	
Improper joint preparation.	Material too thick. Joint preparation and design must provide access to bottom of groove while maintaining proper welding wire extension and arc characteristics.	
Improper weld technique.	Maintain normal gun angle of 0 to 15 degrees to achieve maximum penetration.	
	Keep arc on leading edge of weld puddle.	
	Be sure welding wire extends not more than 1/2 in. (13 mm) beyond nozzle.	
Insufficient heat input.	Select higher wire feed speed and/or select higher voltage range.	
	Reduce travel speed.	
Incorrect polarity.	Check polarity required by welding wire, and change to correct polarity at welding power source.	

## 9-12. Troubleshooting – Incomplete Fusion

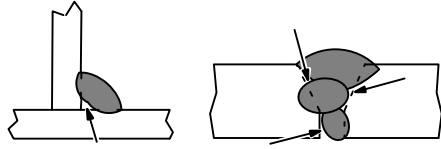
		Incomplete Fusion – failure of weld metal to fuse completely with base metal or a preceding weld bead.
S-0637		
Possible Causes	Corrective Actions	
Workpiece dirty.	Remove all grease, oil, moisture, rust, paint, undercoating, and dirt from work surface before welding.	
Insufficient heat input.	Select higher voltage range and/or adjust wire feed speed.	
Improper welding technique.	Place stringer bead in proper location(s) at joint during welding.	
	Adjust work angle or widen groove to access bottom during welding.	
	Momentarily hold arc on groove side walls when using weaving technique.	
	Keep arc on leading edge of weld puddle.	
	Use correct gun angle of 0 to 15 degrees.	

## 9-13. Troubleshooting – Burn-Through

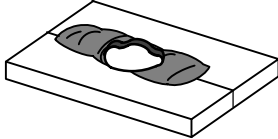
		Burn-Through – weld metal melting completely through base metal resulting in holes where no metal remains.
S-0640		
Possible Causes	Corrective Actions	
Excessive heat input.	Select lower voltage range and reduce wire feed speed.	
	Increase and/or maintain steady travel speed.	



## 9-16. Common GMAW (MIG) Shielding Gases

This is a general chart for common gases and where they are used. Many different combinations (mixtures) of shielding gases have been developed over the years. The most commonly used shielding gases are listed in the following table.

Gas	Application						
	Spray Arc Steel	Short Circuiting Steel	Spray Arc Stainless Steel	Short Circuiting Stainless Steel	Spray Arc Aluminum	Short Circuiting Aluminum	GMAW-P
Argon					All Positions	All Positions	All Positions
Argon + 1% O <sub>2</sub>	Flat & Horizontal Fillet		Flat & Horizontal Fillet				All Positions
Argon + 2% O <sub>2</sub>	Flat & Horizontal Fillet		Flat & Horizontal Fillet				All Positions
Argon + 5% CO <sub>2</sub>	Flat & Horizontal Fillet						All Positions
Argon + 10% CO <sub>2</sub>	Flat & Horizontal Fillet	All Positions					All Positions
Argon + 25% CO <sub>2</sub>		All Positions					
Argon + 50% CO <sub>2</sub>		All Positions					
CO <sub>2</sub>		All Positions					
Helium					All Positions <sup>1</sup>		
Argon + Helium					All Positions <sup>1</sup>		
Tri-Mix <sup>2</sup>				All Positions			

1 Heavy Thicknesses

2 90% HE + 7-1/2% AR + 2-1/2% CO<sub>2</sub>

## 9-17. Troubleshooting Guide For Semiautomatic Welding Equipment

Problem	Probable Cause	Remedy
Wire feed motor operates, but wire does not feed.	Too little pressure on wire feed rolls.	Increase pressure setting on wire feed rolls.
	Incorrect wire feed rolls.	Check size stamped on wire feed rolls, replace to match wire size and type if necessary.
	Wire spool brake pressure too high.	Decrease brake pressure on wire spool.
	Restriction in the gun and/or assembly.	Check and replace cable, gun, and contact tip if damaged. Check size of contact tip and cable liner, replace if necessary.
Wire curling up in front of the wire feed rolls (bird nesting).	Too much pressure on wire feed rolls.	Decrease pressure setting on wire feed rolls.
	Incorrect cable liner or gun contact tip size.	Check size of contact tip and check cable liner length and diameter, replace if necessary.
	Gun end not inserted into drive housing properly.	Loosen gun securing bolt in drive housing and push gun end into housing just enough so it does not touch wire feed rolls.
	Dirty or damaged (kinked) liner.	Replace liner.
Wire feeds, but no gas flows.	Gas cylinder empty.	Replace empty gas cylinder.
	Gas nozzle plugged.	Clean or replace gas nozzle.
	Gas cylinder valve not open or flowmeter not adjusted.	Open gas valve at cylinder and adjust flow rate.
	Restriction in gas line.	Check gas hose between flowmeter and wire feeder, and gas hose in gun and cable assembly.
	Loose or broken wires to gas solenoid.	Have Factory Authorized Service Agent repair wiring.
	Gas solenoid valve not operating.	Have Factory Authorized Service Agent replace gas solenoid valve.
	Incorrect primary voltage connected to welding power source.	Check primary voltage and relink welding power source for correct voltage.
Welding arc not stable.	Wire slipping in drive rolls.	Adjust pressure setting on wire feed rolls. Replace worn drive rolls if necessary.
	Wrong size gun liner or contact tip.	Match liner and contact tip to wire size and type.
	Incorrect voltage setting for selected wire feed speed on welding power source.	Readjust welding parameters.
	Loose connections at the gun weld cable or work cable.	Check and tighten all connections.
	Gun in poor shape or loose connection inside gun.	Repair or replace gun as necessary.

# SECTION 10 – ACCESSORIES/CONSUMABLES

## 10-1. Accessories

Part No.	Description	Remarks
194776	Small Running Gear/Cylinder Rack	For One Small Gas Cylinder, 75 lb (34 kg) max.
195186	Protective Cover	Weatherproof Nylon
245926	H100S4–10 Replacement Gun	10 ft length/.030–.035 wire size
300796	SpoolRunner 100 Spool Gun	For push/pull wire feeding
221037** 770198*	Regulator/Flowmeter	For Argon and Argon mixed shielding gas. Use with replacement hose 269 815.
237702**	Regulator/Flowmeter	For CO <sub>2</sub> shielding gas. Use with replacement gas hose 144108.

\*Available at farm and tool supply retailers.

\*\* Available at Hobart/Miller welding distributors.

## 10-2. Consumables

Item	Hobart Package Part No.*	Miller Package Part No. **
<b>Contact Tips</b>		
.023/.025 in. (0.6 mm)	770174 (5 per package)	087299 (10 per package)
.030 in. (0.8 mm)	770177 (5 per package)	000067 (10 per package)
.035 in. (0.9 mm)	770180 (5 per package)	000068 (10 per package)
.045 in. (1.2 mm)	770183 (5 per package)	000069 (10 per package)
<b>MIG Nozzle (Standard)</b>		
	770404	169715
<b>Gasless Flux Cored Nozzle</b>		
	770487	226190
<b>Tip Adapter</b>		
	770402	169716
<b>Replacement Liners</b>		
.023/.025 in. (0.6 mm)	196139	194010
.030/.035 in. (0.8/0.9 mm)	196139	194011
.035/.045 in. (0.9/1.2 mm)	196140	194012
<b>Replacement Drive Rolls</b>		
<b>For All Feed Head Assemblies</b>		
.023/.025 in. (0.6 mm) and .030/.035 in. (0.8/ 0.9 mm) V and VK Groove	261157	261157
.030/.035 in. (0.8/ 0.9 mm) and .045 in. (1.2 mm) VK Groove	202926	202926

\*Available at farm and tool supply retailers.

\*\* Available at Hobart/Miller welding distributors.

☞ A complete Parts List is available on-line at [www.HobartWelders.com](http://www.HobartWelders.com)

**To maintain the factory original performance of your equipment, use only Manufacturer's Suggested Replacement Parts. Model and serial number required when ordering parts from your local distributor.**





### Warranty Questions?

Call  
1-800-332-3281  
8 AM – 5 PM EST

### Service

You always get the fast, reliable response you need. Most replacement parts can be in your hands in 24 hours.

### Support

Need fast answers to the tough welding questions? Contact your distributor or call 1-800-332-3281. The expertise of the distributor and Hobart is there to help you, every step of the way.

### Assistance

Visit the Hobart website:  
[www.HobartWelders.com](http://www.HobartWelders.com)

Effective January 1, 2018

5/3/1 WARRANTY applies to all Hobart welding equipment, plasma cutters and spot welders with a serial number preface of MJ or newer.

This limited warranty supersedes all previous Hobart warranties and is exclusive with no other guarantees or warranties expressed or implied.

Hobart products are serviced by Hobart or Miller Authorized Service Agencies.

**LIMITED WARRANTY** – Subject to the terms and conditions below, Miller Electric Mfg. LLC, dba Hobart Welding Products, Appleton, Wisconsin, warrants to its original retail purchaser that new Hobart equipment sold after the effective date of this limited warranty is free of defects in material and workmanship at the time it is shipped. THIS WARRANTY IS EXPRESSLY IN LIEU OF ALL OTHER WARRANTIES, EXPRESS OR IMPLIED, INCLUDING THE WARRANTIES OF MERCHANTABILITY AND FITNESS.

Within the warranty periods listed below, Hobart/Miller will repair or replace any warranted parts or components that fail due to such defects in material or workmanship. Hobart/Miller must be notified in writing within thirty (30) days of such defect or failure, at which time Hobart/Miller will provide instructions on the warranty claim procedures to be followed. If notification is submitted as an online warranty claim, the claim must include a detailed description of the fault and the troubleshooting steps taken to identify failed components and the cause of their failure.

Hobart/Miller shall honor warranty claims on warranted equipment listed below in the event of such a failure within the warranty time periods. All warranty time periods start on the delivery date of the equipment to the original retail purchaser, and not to exceed twelve months after the equipment is shipped to a North American distributor or twelve months after the equipment is shipped to an International distributor.

1. 5 Years — Parts and Labor
  - \* Original Main Power Rectifiers only to include SCRs, diodes, and discrete rectifier modules
  - \* Reactors
  - \* Stabilizers
  - \* Transformers
2. 3 Years — Parts and Labor
  - \* Drive Systems
  - \* Idle Module
  - \* PC Boards
  - \* Rotors, Stators and Brushes
  - \* Solenoid Valves
  - \* Spot Welder Transformer
  - \* Switches and Controls
  - \* MIG Flowgauge Regulators (No Labor)
3. 1 Year — Parts and Labor Unless Specified (90 days for industrial use)
  - \* Accessories
  - \* Batteries (Trek 180 Only)
  - \* Contactors
  - \* Field Options  
(NOTE: Field options are covered for the remaining warranty period of the product they are installed in, or for a minimum of one year — whichever is greater.)
  - \* HF Units
  - \* MIG Guns/TIG Torches
  - \* Motor-Driven Guns
  - \* Plasma Cutting Torches
  - \* Relays
  - \* Remote Controls
  - \* Replacement Parts (No labor) – 90 days
  - \* Running Gear/Trailers
  - \* Water Cooling Systems
  - \* Spoolguns

4. 6 Months — Parts
  - \* Batteries
5. Engines and tires are warranted separately by the manufacturer.

Hobart's 5/3/1 Limited Warranty shall not apply to:

1. **Consumable components; such as contact tips, cutting nozzles, contactors, brushes, relays, work station table tops and welding curtains, or parts that fail due to normal wear. (Exception: brushes and relays are covered on all engine-driven products.)**
2. Items furnished by Hobart/Miller, but manufactured by others, such as engines or trade accessories. These items are covered by the manufacturer's warranty, if any.
3. Equipment that has been modified by any party other than Hobart/Miller, or equipment that has been improperly installed, improperly operated or misused based upon industry standards, or equipment which has not had reasonable and necessary maintenance, or equipment which has been used for operation outside of the specifications for the equipment.

HOBART PRODUCTS ARE INTENDED FOR COMMERCIAL AND INDUSTRIAL USERS TRAINED AND EXPERIENCED IN THE USE AND MAINTENANCE OF WELDING EQUIPMENT.

The exclusive remedies for warranty claims are, at Hobart's/Miller's option, either: (1) repair; or (2) replacement; or, if approved in writing by Hobart/Miller, (3) the pre-approved cost of repair or replacement at an authorized Hobart/Miller service station; or (4) payment of or credit for the purchase price (less reasonable depreciation based upon use). Products may not be returned without Hobart's/Miller's written approval. Return shipment shall be at customer's risk and expense.

The above remedies are F.O.B. Appleton, WI, or Hobart's/Miller's authorized service facility. Transportation and freight are the customer's responsibility. TO THE EXTENT PERMITTED BY LAW, THE REMEDIES HEREIN ARE THE SOLE AND EXCLUSIVE REMEDIES REGARDLESS OF THE LEGAL THEORY. IN NO EVENT SHALL HOBART/MILLER BE LIABLE FOR DIRECT, INDIRECT, SPECIAL, INCIDENTAL OR CONSEQUENTIAL DAMAGES (INCLUDING LOSS OF PROFIT) REGARDLESS OF THE LEGAL THEORY. ANY WARRANTY NOT PROVIDED HEREIN AND ANY IMPLIED WARRANTY, GUARANTY, OR REPRESENTATION, INCLUDING ANY IMPLIED WARRANTY OF MERCHANTABILITY OR FITNESS FOR PARTICULAR PURPOSE, ARE EXCLUDED AND DISCLAIMED BY HOBART/MILLER.

Some US states do not allow limiting the duration of an implied warranty or the exclusion of certain damages, so the above limitations may not apply to you. This warranty provides specific legal rights, and other rights may be available depending on your state. In Canada, some provinces provide additional warranties or remedies, and to the extent the law prohibits their waiver, the limitations set out above may not apply. This Limited Warranty provides specific legal rights, and other rights may be available, but may vary by province.





Thank you for purchasing Hobart. Our trained technical support team is dedicated to your satisfaction. For questions regarding performance, operation, or service, contact us!

## Resources Available

Always provide Model Name and Serial/Style Number.

### To locate a Service Center:

Call 1-800-332-3281  
or visit our website at [www.HobartWelders.com/wheretobuy](http://www.HobartWelders.com/wheretobuy)

### For Technical Assistance:

Call 1-800-332-3281  
8 AM to 5 PM EST – Monday through Friday



## Owner's Record

Please complete and retain with your personal records.

_____	
Model Name	Serial/Style Number
_____	
Purchase Date	(Date which equipment was delivered to original customer.)
_____	
Distributor	
_____	
Address	
_____	
City	
_____	
State	Zip
_____	_____
_____	

**Miller Electric Mfg. LLC**  
An Illinois Tool Works Company  
1635 West Spencer Street  
Appleton, WI 54914 USA

**For Assistance:**  
Call 1-800-332-3281

