



OM-228 187B

2010-01

Processes



MIG (GMAW) Welding

Flux Cored (FCAW) Welding

Description



Arc Welding Power Source And Wire Feeder

Handler[®] 187 And H100S2-10 Gun

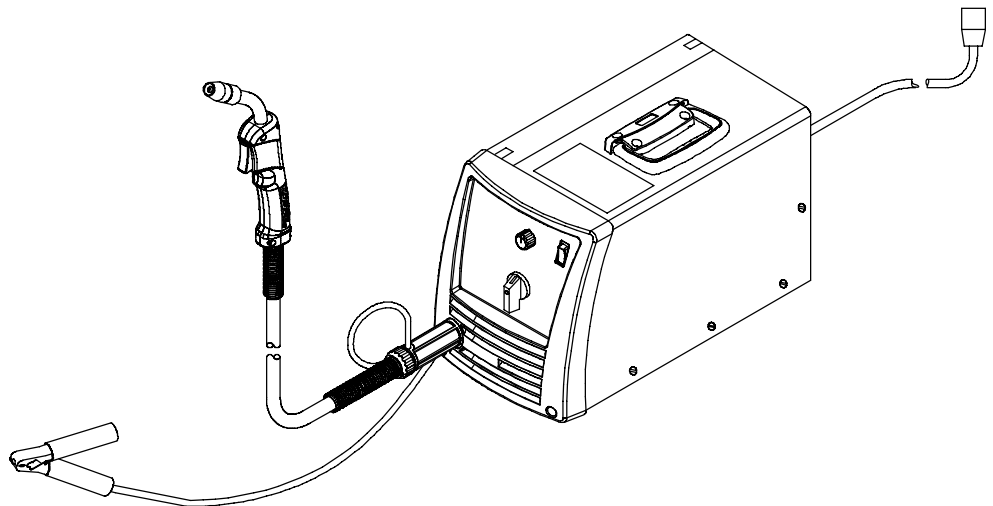

www.HobartWelders.com



OWNER'S MANUAL

From Hobart to You

Thank you and congratulations on choosing Hobart. Now you can get the job done and get it done right. We know you don't have time to do it any other way.

This Owner's Manual is designed to help you get the most out of your Hobart products. Please take time to read the Safety precautions. They will help you protect yourself against potential hazards on the worksite.



Hobart is registered to the ISO 9001 Quality System Standard.

We've made installation and operation quick and easy. With Hobart you can count on years of reliable service with proper maintenance. And if for some reason the unit needs repair, there's a Troubleshooting section that will help you figure out what the problem is. The parts list will then help you to decide the exact part you may need to fix the problem. Warranty and service information for your particular model are also provided.

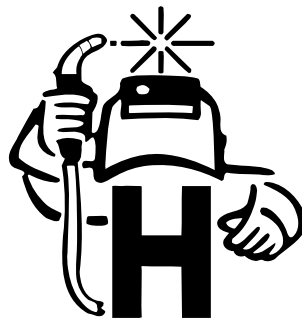

Hobart Welders manufactures a full line of welders and welding related equipment. For information on other quality Hobart products, contact your local Hobart distributor to receive the latest full line catalog or individual specification sheets. **To locate your nearest distributor or service agency call 1-877-Hobart1 or visit our website at www.HobartWelders.com.**

For Technical Help call 1-800-332-3281.

5/3/1 WARRANTY

Working as hard as you do – every power source from Hobart is backed by the best warranty in the business.

Protect Your Investment!



Register your product at:
HobartWelders.com

TABLE OF CONTENTS

SECTION 1 – SAFETY PRECAUTIONS - READ BEFORE USING	1
1-1. Symbol Usage	1
1-2. Arc Welding Hazards	1
1-3. Additional Symbols For Installation, Operation, And Maintenance	3
1-4. California Proposition 65 Warnings	4
1-5. Principal Safety Standards	4
1-6. EMF Information	4
SECTION 2 – CONSIGNES DE SÉCURITÉ – LIRE AVANT UTILISATION	5
2-1. Symboles utilisés	5
2-2. Dangers relatifs au soudage à l'arc	5
2-3. Dangers supplémentaires en relation avec l'installation, le fonctionnement et la maintenance	7
2-4. Proposition californienne 65 Avertissements	8
2-5. Principales normes de sécurité	9
2-6. Informations relatives aux CEM	9
SECTION 3 – DEFINITIONS	11
3-1. Symbols And Definitions	11
SECTION 4 – SPECIFICATIONS	11
4-1. Specifications	11
4-2. Duty Cycle And Overheating	12
4-3. Volt-Ampere Curves	12
SECTION 5 – INSTALLATION	13
5-1. Installing Nozzle, Contact Tip, And Adapter	13
5-2. Installing Welding Gun	13
5-3. Installing Work Clamp	14
5-4. Process/Polarity Table	15
5-5. Changing Polarity	15
5-6. Installing Gas Supply	16
5-7. Selecting A Location And Connecting Input Power	17
5-8. Electrical Service Guide	18
5-9. Installing Wire Spool And Adjusting Hub Tension	18
5-10. Threading Welding Wire	19
SECTION 6 – OPERATION	20
6-1. Controls	20
6-2. Weld Parameter Chart For 230 VAC Model	22
SECTION 7 – MAINTENANCE & TROUBLESHOOTING	24
7-1. Routine Maintenance	24
7-2. Overload Protection	24
7-3. Drive Motor Protection	24
7-4. Changing Drive Roll Or Wire Inlet Guide	25
7-5. Changing Nozzle, Contact Tip, Adapter And Liner, And Cleaning Gun Casing	26
7-6. Replacing Switch And/Or Head Tube	27
7-7. Troubleshooting Table	28
SECTION 8 – ELECTRICAL DIAGRAM	30

TABLE OF CONTENTS

SECTION 9 – MIG WELDING (GMAW) GUIDELINES	32
9-1. Typical MIG Process Connections	32
9-2. Typical MIG Process Control Settings	33
9-3. Holding And Positioning Welding Gun	34
9-4. Conditions That Affect Weld Bead Shape	35
9-5. Gun Movement During Welding	36
9-6. Poor Weld Bead Characteristics	36
9-7. Good Weld Bead Characteristics	36
9-8. Troubleshooting – Excessive Spatter	37
9-9. Troubleshooting – Porosity	37
9-10. Troubleshooting – Excessive Penetration	37
9-11. Troubleshooting – Lack Of Penetration	38
9-12. Troubleshooting – Incomplete Fusion	38
9-13. Troubleshooting – Burn-Through	38
9-14. Troubleshooting – Waviness Of Bead	39
9-15. Troubleshooting – Distortion	39
9-16. Common MIG Shielding Gases	40
9-17. Troubleshooting Guide For Semiautomatic Welding Equipment	40
SECTION 10 – PARTS LIST	42
WARRANTY	

SECTION 1 – SAFETY PRECAUTIONS - READ BEFORE USING

som_2009-08

 Protect yourself and others from injury — read and follow these precautions.

1-1. Symbol Usage

 **DANGER!** – Indicates a hazardous situation which, if not avoided, will result in death or serious injury. The possible hazards are shown in the adjoining symbols or explained in the text.

 Indicates a hazardous situation which, if not avoided, could result in death or serious injury. The possible hazards are shown in the adjoining symbols or explained in the text.

NOTICE – Indicates statements not related to personal injury.

 Indicates special instructions.



This group of symbols means Warning! Watch Out! ELECTRIC SHOCK, MOVING PARTS, and HOT PARTS hazards. Consult symbols and related instructions below for necessary actions to avoid the hazards.

1-2. Arc Welding Hazards

 The symbols shown below are used throughout this manual to call attention to and identify possible hazards. When you see the symbol, watch out, and follow the related instructions to avoid the hazard. The safety information given below is only a summary of the more complete safety information found in the Safety Standards listed in Section 1-5. Read and follow all Safety Standards.

 Only qualified persons should install, operate, maintain, and repair this unit.

 During operation, keep everybody, especially children, away.



ELECTRIC SHOCK can kill.

Touching live electrical parts can cause fatal shocks or severe burns. The electrode and work circuit is electrically live whenever the output is on. The input power circuit and machine internal circuits are also live when power is on. In semiautomatic or automatic wire welding, the wire, wire reel, drive roll housing, and all metal parts touching the welding wire are electrically live. Incorrectly installed or improperly grounded equipment is a hazard.

- Do not touch live electrical parts.
- Wear dry, hole-free insulating gloves and body protection.
- Insulate yourself from work and ground using dry insulating mats or covers big enough to prevent any physical contact with the work or ground.
- Do not use AC output in damp areas, if movement is confined, or if there is a danger of falling.
- Use AC output ONLY if required for the welding process.
- If AC output is required, use remote output control if present on unit.
- Additional safety precautions are required when any of the following electrically hazardous conditions are present: in damp locations or while wearing wet clothing; on metal structures such as floors, gratings, or scaffolds; when in cramped positions such as sitting, kneeling, or lying; or when there is a high risk of unavoidable or accidental contact with the workpiece or ground. For these conditions, use the following equipment in order presented: 1) a semiautomatic DC constant voltage (wire) welder, 2) a DC manual (stick) welder, or 3) an AC welder with reduced open-circuit voltage. In most situations, use of a DC, constant voltage wire welder is recommended. And, do not work alone!
- Disconnect input power or stop engine before installing or servicing this equipment. Lockout/tagout input power according to OSHA 29 CFR 1910.147 (see Safety Standards).

- Properly install and ground this equipment according to its Owner's Manual and national, state, and local codes.
- Always verify the supply ground – check and be sure that input power cord ground wire is properly connected to ground terminal in disconnect box or that cord plug is connected to a properly grounded receptacle outlet.
- When making input connections, attach proper grounding conductor first – double-check connections.
- Keep cords dry, free of oil and grease, and protected from hot metal and sparks.
- Frequently inspect input power cord for damage or bare wiring – replace cord immediately if damaged – bare wiring can kill.
- Turn off all equipment when not in use.
- Do not use worn, damaged, undersized, or poorly spliced cables.
- Do not drape cables over your body.
- If earth grounding of the workpiece is required, ground it directly with a separate cable.
- Do not touch electrode if you are in contact with the work, ground, or another electrode from a different machine.
- Do not touch electrode holders connected to two welding machines at the same time since double open-circuit voltage will be present.
- Use only well-maintained equipment. Repair or replace damaged parts at once. Maintain unit according to manual.
- Wear a safety harness if working above floor level.
- Keep all panels and covers securely in place.
- Clamp work cable with good metal-to-metal contact to workpiece or worktable as near the weld as practical.
- Insulate work clamp when not connected to workpiece to prevent contact with any metal object.
- Do not connect more than one electrode or work cable to any single weld output terminal.

SIGNIFICANT DC VOLTAGE exists in inverter welding power sources AFTER removal of input power.

- Turn Off inverter, disconnect input power, and discharge input capacitors according to instructions in Maintenance Section before touching any parts.



HOT PARTS can burn.

- Do not touch hot parts bare handed.
- Allow cooling period before working on equipment.
- To handle hot parts, use proper tools and/or wear heavy, insulated welding gloves and clothing to prevent burns.



FUMES AND GASES can be hazardous.

Welding produces fumes and gases. Breathing these fumes and gases can be hazardous to your health.

- Keep your head out of the fumes. Do not breathe the fumes.
- If inside, ventilate the area and/or use local forced ventilation at the arc to remove welding fumes and gases.
- If ventilation is poor, wear an approved air-supplied respirator.
- Read and understand the Material Safety Data Sheets (MSDSs) and the manufacturer's instructions for metals, consumables, coatings, cleaners, and degreasers.
- Work in a confined space only if it is well ventilated, or while wearing an air-supplied respirator. Always have a trained watch-person nearby. Welding fumes and gases can displace air and lower the oxygen level causing injury or death. Be sure the breathing air is safe.
- Do not weld in locations near degreasing, cleaning, or spraying operations. The heat and rays of the arc can react with vapors to form highly toxic and irritating gases.
- Do not weld on coated metals, such as galvanized, lead, or cadmium plated steel, unless the coating is removed from the weld area, the area is well ventilated, and while wearing an air-supplied respirator. The coatings and any metals containing these elements can give off toxic fumes if welded.



ARC RAYS can burn eyes and skin.

Arc rays from the welding process produce intense visible and invisible (ultraviolet and infrared) rays that can burn eyes and skin. Sparks fly off from the weld.

- Wear an approved welding helmet fitted with a proper shade of filter lenses to protect your face and eyes from arc rays and sparks when welding or watching (see ANSI Z49.1 and Z87.1 listed in Safety Standards).
- Wear approved safety glasses with side shields under your helmet.
- Use protective screens or barriers to protect others from flash, glare and sparks; warn others not to watch the arc.
- Wear protective clothing made from durable, flame-resistant material (leather, heavy cotton, or wool) and foot protection.



WELDING can cause fire or explosion.

Welding on closed containers, such as tanks, drums, or pipes, can cause them to blow up. Sparks can fly off from the welding arc. The flying sparks, hot workpiece, and hot equipment can cause fires and burns. Accidental contact of electrode to metal objects can cause sparks, explosion, overheating, or fire. Check and be sure the area is safe before doing any welding.

- Remove all flammables within 35 ft (10.7 m) of the welding arc. If this is not possible, tightly cover them with approved covers.
- Do not weld where flying sparks can strike flammable material.
- Protect yourself and others from flying sparks and hot metal.
- Be alert that welding sparks and hot materials from welding can easily go through small cracks and openings to adjacent areas.
- Watch for fire, and keep a fire extinguisher nearby.
- Be aware that welding on a ceiling, floor, bulkhead, or partition can cause fire on the hidden side.
- Do not weld on closed containers such as tanks, drums, or pipes, unless they are properly prepared according to AWS F4.1 (see Safety Standards).
- Do not weld where the atmosphere may contain flammable dust, gas, or liquid vapors (such as gasoline).
- Connect work cable to the work as close to the welding area as practical to prevent welding current from traveling long, possibly unknown paths and causing electric shock, sparks, and fire hazards.
- Do not use welder to thaw frozen pipes.

- Remove stick electrode from holder or cut off welding wire at contact tip when not in use.
- Wear oil-free protective garments such as leather gloves, heavy shirt, cuffless trousers, high shoes, and a cap.
- Remove any combustibles, such as a butane lighter or matches, from your person before doing any welding.
- After completion of work, inspect area to ensure it is free of sparks, glowing embers, and flames.
- Use only correct fuses or circuit breakers. Do not oversize or bypass them.
- Follow requirements in OSHA 1910.252 (a) (2) (iv) and NFPA 51B for hot work and have a fire watcher and extinguisher nearby.

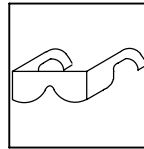

FLYING METAL or DIRT can injure eyes.

- Welding, chipping, wire brushing, and grinding cause sparks and flying metal. As welds cool, they can throw off slag.
- Wear approved safety glasses with side shields even under your welding helmet.



BUILDUP OF GAS can injure or kill.

- Shut off shielding gas supply when not in use.
- Always ventilate confined spaces or use approved air-supplied respirator.

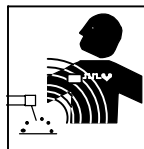

ELECTRIC AND MAGNETIC FIELDS (EMF) can affect Implanted Medical Devices.

- Wearers of Pacemakers and other Implanted Medical Devices should keep away.
- Implanted Medical Device wearers should consult their doctor and the device manufacturer before going near arc welding, spot welding, gouging, plasma arc cutting, or induction heating operations.

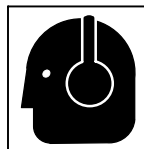

NOISE can damage hearing.

Noise from some processes or equipment can damage hearing.

- Wear approved ear protection if noise level is high.

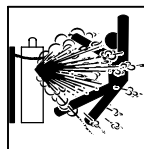

CYLINDERS can explode if damaged.

Shielding gas cylinders contain gas under high pressure. If damaged, a cylinder can explode. Since gas cylinders are normally part of the welding process, be sure to treat them carefully.

- Protect compressed gas cylinders from excessive heat, mechanical shocks, physical damage, slag, open flames, sparks, and arcs.
- Install cylinders in an upright position by securing to a stationary support or cylinder rack to prevent falling or tipping.
- Keep cylinders away from any welding or other electrical circuits.
- Never drape a welding torch over a gas cylinder.
- Never allow a welding electrode to touch any cylinder.
- Never weld on a pressurized cylinder – explosion will result.
- Use only correct shielding gas cylinders, regulators, hoses, and fittings designed for the specific application; maintain them and associated parts in good condition.
- Turn face away from valve outlet when opening cylinder valve.
- Keep protective cap in place over valve except when cylinder is in use or connected for use.
- Use the right equipment, correct procedures, and sufficient number of persons to lift and move cylinders.
- Read and follow instructions on compressed gas cylinders, associated equipment, and Compressed Gas Association (CGA) publication P-1 listed in Safety Standards.

1-3. Additional Symbols For Installation, Operation, And Maintenance



FIRE OR EXPLOSION hazard.

- Do not install or place unit on, over, or near combustible surfaces.
- Do not install unit near flammables.
- Do not overload building wiring – be sure power supply system is properly sized, rated, and protected to handle this unit.



FALLING EQUIPMENT can injure.

- Use lifting eye to lift unit only, NOT running gear, gas cylinders, or any other accessories.
- Use equipment of adequate capacity to lift and support unit.
- If using lift forks to move unit, be sure forks are long enough to extend beyond opposite side of unit.
- Keep equipment (cables and cords) away from moving vehicles when working from an aerial location.
- Follow the guidelines in the Applications Manual for the Revised NIOSH Lifting Equation (Publication No. 94-110) when manually lifting heavy parts or equipment.

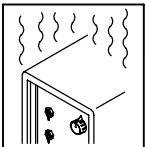

OVERUSE can cause OVERHEATING

- Allow cooling period; follow rated duty cycle.
- Reduce current or reduce duty cycle before starting to weld again.
- Do not block or filter airflow to unit.

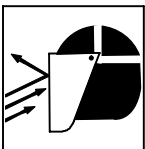

FLYING SPARKS can injure.

- Wear a face shield to protect eyes and face.
- Shape tungsten electrode only on grinder with proper guards in a safe location wearing proper face, hand, and body protection.
- Sparks can cause fires — keep flammables away.

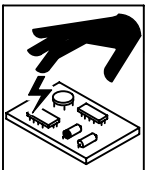

STATIC (ESD) can damage PC boards.

- Put on grounded wrist strap BEFORE handling boards or parts.
- Use proper static-proof bags and boxes to store, move, or ship PC boards.



MOVING PARTS can injure.

- Keep away from moving parts.
- Keep away from pinch points such as drive rolls.



WELDING WIRE can injure.

- Do not press gun trigger until instructed to do so.
- Do not point gun toward any part of the body, other people, or any metal when threading welding wire.



MOVING PARTS can injure.

- Keep away from moving parts such as fans.
- Keep all doors, panels, covers, and guards closed and securely in place.
- Have only qualified persons remove doors, panels, covers, or guards for maintenance and troubleshooting as necessary.
- Reinstall doors, panels, covers, or guards when maintenance is finished and before reconnecting input power.

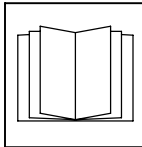

READ INSTRUCTIONS.

- Read and follow all labels and the Owner's Manual carefully before installing, operating, or servicing unit. Read the safety information at the beginning of the manual and in each section.
- Use only genuine replacement parts from the manufacturer.
- Perform maintenance and service according to the Owner's Manuals, industry standards, and national, state, and local codes.

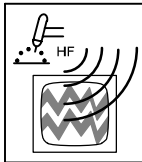

H.F. RADIATION can cause interference.

- High-frequency (H.F.) can interfere with radio navigation, safety services, computers, and communications equipment.
- Have only qualified persons familiar with electronic equipment perform this installation.
- The user is responsible for having a qualified electrician promptly correct any interference problem resulting from the installation.
- If notified by the FCC about interference, stop using the equipment at once.
- Have the installation regularly checked and maintained.
- Keep high-frequency source doors and panels tightly shut, keep spark gaps at correct setting, and use grounding and shielding to minimize the possibility of interference.

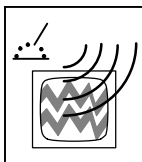

ARC WELDING can cause interference.

- Electromagnetic energy can interfere with sensitive electronic equipment such as computers and computer-driven equipment such as robots.
- Be sure all equipment in the welding area is electromagnetically compatible.
- To reduce possible interference, keep weld cables as short as possible, close together, and down low, such as on the floor.
- Locate welding operation 100 meters from any sensitive electronic equipment.
- Be sure this welding machine is installed and grounded according to this manual.
- If interference still occurs, the user must take extra measures such as moving the welding machine, using shielded cables, using line filters, or shielding the work area.

1-4. California Proposition 65 Warnings

 Welding or cutting equipment produces fumes or gases which contain chemicals known to the State of California to cause birth defects and, in some cases, cancer. (California Health & Safety Code Section 25249.5 et seq.)

 Battery posts, terminals and related accessories contain lead and lead compounds, chemicals known to the State of California to cause cancer and birth defects or other reproductive harm. Wash hands after handling.

For Gasoline Engines:

 Engine exhaust contains chemicals known to the State of California to cause cancer, birth defects, or other reproductive harm.

For Diesel Engines:

 Diesel engine exhaust and some of its constituents are known to the State of California to cause cancer, birth defects, and other reproductive harm.

1-5. Principal Safety Standards

Safety in Welding, Cutting, and Allied Processes, ANSI Standard Z49.1, from Global Engineering Documents (phone: 1-877-413-5184, website: www.global.ihs.com).

Safe Practices for the Preparation of Containers and Piping for Welding and Cutting, American Welding Society Standard AWS F4.1, from Global Engineering Documents (phone: 1-877-413-5184, website: www.global.ihs.com).

National Electrical Code, NFPA Standard 70, from National Fire Protection Association, Quincy, MA 02269 (phone: 1-800-344-3555, website: www.nfpa.org and www.sparky.org).

Safe Handling of Compressed Gases in Cylinders, CGA Pamphlet P-1, from Compressed Gas Association, 4221 Walney Road, 5th Floor, Chantilly, VA 20151 (phone: 703-788-2700, website: www.cganet.com).

Safety in Welding, Cutting, and Allied Processes, CSA Standard W117.2, from Canadian Standards Association, Standards Sales, 5060 Spectrum Way, Suite 100, Ontario, Canada L4W 5NS (phone: 800-463-6727, website: www.csa-international.org).

Safe Practice For Occupational And Educational Eye And Face Protection, ANSI Standard Z87.1, from American National Standards Institute,

25 West 43rd Street, New York, NY 10036 (phone: 212-642-4900, website: www.ansi.org).

Standard for Fire Prevention During Welding, Cutting, and Other Hot Work, NFPA Standard 51B, from National Fire Protection Association, Quincy, MA 02269 (phone: 1-800-344-3555, website: www.nfpa.org).

OSHA, Occupational Safety and Health Standards for General Industry, Title 29, Code of Federal Regulations (CFR), Part 1910, Subpart Q, and Part 1926, Subpart J, from U.S. Government Printing Office, Superintendent of Documents, P.O. Box 371954, Pittsburgh, PA 15250-7954 (phone: 1-866-512-1800) (there are 10 OSHA Regional Offices—phone for Region 5, Chicago, is 312-353-2220, website: www.osha.gov).

U.S. Consumer Product Safety Commission (CPSC), 4330 East West Highway, Bethesda, MD 20814 (phone: 301-504-7923, website: www.cpsc.gov).

Applications Manual for the Revised NIOSH Lifting Equation, The National Institute for Occupational Safety and Health (NIOSH), 1600 Clifton Rd, Atlanta, GA 30333 (phone: 1-800-232-4636, website: www.cdc.gov/NIOSH).

1-6. EMF Information

Electric current flowing through any conductor causes localized electric and magnetic fields (EMF). Welding current creates an EMF field around the welding circuit and welding equipment. EMF fields may interfere with some medical implants, e.g. pacemakers. Protective measures for persons wearing medical implants have to be taken. For example, access restrictions for passers-by or individual risk assessment for welders. All welders should use the following procedures in order to minimize exposure to EMF fields from the welding circuit:

1. Keep cables close together by twisting or taping them, or using a cable cover.
2. Do not place your body between welding cables. Arrange cables to one side and away from the operator.
3. Do not coil or drape cables around your body.

4. Keep head and trunk as far away from the equipment in the welding circuit as possible.
5. Connect work clamp to workpiece as close to the weld as possible.
6. Do not work next to, sit or lean on the welding power source.
7. Do not weld whilst carrying the welding power source or wire feeder.

About Implanted Medical Devices:

Implanted Medical Device wearers should consult their doctor and the device manufacturer before performing or going near arc welding, spot welding, gouging, plasma arc cutting, or induction heating operations. If cleared by your doctor, then following the above procedures is recommended.

SECTION 2 – CONSIGNES DE SÉCURITÉ – LIRE AVANT UTILISATION

fre_som_2009-08

! Se protéger et protéger les autres contre le risque de blessure — lire et respecter ces consignes.

2-1. Symboles utilisés



DANGER! – Indique une situation dangereuse qui si on l'évite pas peut donner la mort ou des blessures graves. Les dangers possibles sont montrés par les symboles joints ou sont expliqués dans le texte.



Indique une situation dangereuse qui si on l'évite pas peut donner la mort ou des blessures graves. Les dangers possibles sont montrés par les symboles joints ou sont expliqués dans le texte.

NOTE – Indique des déclarations pas en relation avec des blessures personnelles.

 Indique des instructions spécifiques.



Ce groupe de symboles veut dire Avertissement! Attention! DANGER DE CHOC ELECTRIQUE, PIECES EN MOUVEMENT, et PIECES CHAUDES. Consulter les symboles et les instructions ci-dessous y afférant pour les actions nécessaires afin d'éviter le danger.

2-2. Dangers relatifs au soudage à l'arc



Les symboles représentés ci-dessous sont utilisés dans ce manuel pour attirer l'attention et identifier les dangers possibles. En présence de l'un de ces symboles, prendre garde et suivre les instructions afférentes pour éviter tout risque. Les instructions en matière de sécurité indiquées ci-dessous ne constituent qu'un sommaire des instructions de sécurité plus complètes fournies dans les normes de sécurité énumérées dans la Section 2-5. Lire et observer toutes les normes de sécurité.



Seul un personnel qualifié est autorisé à installer, faire fonctionner, entretenir et réparer cet appareil.



Pendant le fonctionnement, maintenir à distance toutes les personnes, notamment les enfants de l'appareil.



UNE DÉCHARGE ÉLECTRIQUE peut entraîner la mort.

Le contact d'organes électriques sous tension peut provoquer des accidents mortels ou des brûlures graves. Le circuit de l'électrode et de la pièce est sous tension lorsque le courant est délivré à la sortie. Le circuit d'alimentation et les circuits internes de la machine sont également sous tension lorsque l'alimentation est sur Marche. Dans le mode de soudage avec du fil, le fil, le dérouleur, le bloc de commande du rouleau et toutes les parties métalliques en contact avec le fil sont sous tension électrique. Un équipement installé ou mis à la terre de manière incorrecte ou impropre constitue un danger.

- Ne pas toucher aux pièces électriques sous tension.
 - Porter des gants isolants et des vêtements de protection secs et sans trous.
 - S'isoler de la pièce à couper et du sol en utilisant des housses ou des tapis assez grands afin d'éviter tout contact physique avec la pièce à couper ou le sol.
 - Ne pas se servir de source électrique à courant électrique dans les zones humides, dans les endroits confinés ou là où on risque de tomber.
 - Se servir d'une source électrique à courant électrique UNIQUEMENT si le procédé de soudage le demande.
 - Si l'utilisation d'une source électrique à courant électrique s'avère nécessaire, se servir de la fonction de télécommande si l'appareil en est équipé.
 - D'autres consignes de sécurité sont nécessaires dans les conditions suivantes : risques électriques dans un environnement humide ou si l'on porte des vêtements mouillés ; sur des structures métalliques telles que sols, grilles ou échafaudages ; en position coincée comme assise, à genoux ou couchée ; ou s'il y a un risque élevé de contact inévitable ou accidentel avec la pièce à souder ou le sol. Dans ces conditions, utiliser les équipements suivants,
- dans l'ordre indiqué : 1) un poste à souder DC à tension constante (à fil), 2) un poste à souder DC manuel (électrode) ou 3) un poste à souder AC à tension à vide réduite. Dans la plupart des situations, l'utilisation d'un poste à souder DC à fil à tension constante est recommandée. En outre, ne pas travailler seul !
- Couper l'alimentation ou arrêter le moteur avant de procéder à l'installation, à la réparation ou à l'entretien de l'appareil. Déverrouiller l'alimentation selon la norme OSHA 29 CFR 1910.147 (voir normes de sécurité).
 - Installer le poste correctement et le mettre à la terre convenablement selon les consignes du manuel de l'opérateur et les normes nationales, provinciales et locales.
 - Toujours vérifier la terre du cordon d'alimentation. Vérifier et s'assurer que le fil de terre du cordon d'alimentation est bien raccordé à la borne de terre du sectionneur ou que la fiche du cordon est raccordée à une prise correctement mise à la terre.
 - En effectuant les raccordements d'entrée, fixer d'abord le conducteur de mise à la terre approprié et contre-vérifier les connexions.
 - Les câbles doivent être exempts d'humidité, d'huile et de graisse; protégez-les contre les étincelles et les pièces métalliques chaudes.
 - Vérifier fréquemment le cordon d'alimentation afin de s'assurer qu'il n'est pas altéré ou à nu, le remplacer immédiatement s'il l'est. Un fil à nu peut entraîner la mort.
 - L'équipement doit être hors tension lorsqu'il n'est pas utilisé.
 - Ne pas utiliser des câbles usés, endommagés, de grosseur insuffisante ou mal épissés.
 - Ne pas enrouler les câbles autour du corps.
 - Si la pièce soudée doit être mise à la terre, le faire directement avec un câble distinct.
 - Ne pas toucher l'électrode quand on est en contact avec la pièce, la terre ou une électrode provenant d'une autre machine.
 - Ne pas toucher des porte électrodes connectés à deux machines en même temps à cause de la présence d'une tension à vide doublée.
 - N'utiliser qu'un matériel en bon état. Réparer ou remplacer sur-le-champ les pièces endommagées. Entretenir l'appareil conformément à ce manuel.
 - Porter un harnais de sécurité si l'on doit travailler au-dessus du sol.
 - S'assurer que tous les panneaux et couvercles sont correctement en place.
 - Fixer le câble de retour de façon à obtenir un bon contact métal-métal avec la pièce à souder ou la table de travail, le plus près possible de la soudure.
 - Isoler la pince de masse quand pas mis à la pièce pour éviter le contact avec tout objet métallique.
 - Ne pas raccorder plus d'une électrode ou plus d'un câble de masse à une même borne de sortie de soudage.

Il reste une TENSION DC NON NÉGLIGEABLE dans les sources de soudage onduleur UNE FOIS l'alimentation coupée.

- Arrêter les convertisseurs, débrancher le courant électrique et décharger les condensateurs d'alimentation selon les instructions indiquées dans la partie Entretien avant de toucher les pièces.



LES PIÈCES CHAUDES peuvent provoquer des brûlures.

- Ne pas toucher à mains nues les parties chaudes.
- Prévoir une période de refroidissement avant de travailler à l'équipement.
- Ne pas toucher aux pièces chaudes, utiliser les outils recommandés et porter des gants de soudage et des vêtements épais pour éviter les brûlures.



LES FUMÉES ET LES GAZ peuvent être dangereux.

Le soudage génère des fumées et des gaz. Leur inhalation peut être dangereux pour votre santé.

- Eloigner votre tête des fumées. Ne pas respirer les fumées.
- À l'intérieur, ventiler la zone et/ou utiliser une ventilation forcée au niveau de l'arc pour l'évacuation des fumées et des gaz de soudage.
- Si la ventilation est médiocre, porter un respirateur anti-vapeurs approuvé.
- Lire et comprendre les spécifications de sécurité des matériaux (MSDS) et les instructions du fabricant concernant les métaux, les consommables, les revêtements, les nettoyants et les dégraissants.
- Travailler dans un espace fermé seulement s'il est bien ventilé ou en portant un respirateur à alimentation d'air. Demander toujours à un surveillant dûment formé de se tenir à proximité. Des fumées et des gaz de soudage peuvent déplacer l'air et abaisser le niveau d'oxygène provoquant des blessures ou des accidents mortels. S'assurer que l'air de respiration ne présente aucun danger.
- Ne pas souder dans des endroits situés à proximité d'opérations de dégraissage, de nettoyage ou de pulvérisation. La chaleur et les rayons de l'arc peuvent réagir en présence de vapeurs et former des gaz hautement toxiques et irritants.
- Ne pas souder des métaux munis d'un revêtement, tels que l'acier galvanisé, plaqué en plomb ou au cadmium à moins que le revêtement n'ait été enlevé dans la zone de soudure, que l'endroit soit bien ventilé, et en portant un respirateur à alimentation d'air. Les revêtements et tous les métaux renfermant ces éléments peuvent dégager des fumées toxiques en cas de soudage.



LES RAYONS DE L'ARC peuvent provoquer des brûlures dans les yeux et sur la peau.

Le rayonnement de l'arc du procédé de soudage génère des rayons visibles et invisibles intenses (ultraviolets et infrarouges) susceptibles de provoquer des brûlures dans les yeux et sur la peau. Des étincelles sont projetées pendant le soudage.

- Porter un casque de soudage approuvé muni de verres filtrants appropriés pour protéger visage et yeux pour protéger votre visage et vos yeux pendant le soudage ou pour regarder (voir ANSI Z49.1 et Z87.1 énuméré dans les normes de sécurité).
- Porter des lunettes de sécurité avec écrans latéraux même sous votre casque.
- Avoir recours à des écrans protecteurs ou à des rideaux pour protéger les autres contre les rayonnements les éblouissements et les étincelles ; prévenir toute personne sur les lieux de ne pas regarder l'arc.

- Porter des vêtements confectionnés avec des matières résistantes et ignifuges (cuir, coton lourd ou laine) et des bottes de protection.



LE SOUDAGE peut provoquer un incendie ou une explosion.

Le soudage effectué sur des conteneurs fermés tels que des réservoirs, tambours ou des conduites peut provoquer leur éclatement. Des étincelles peuvent être projetées de l'arc de soudage. La projection d'étincelles, des pièces chaudes et des équipements chauds peut provoquer des incendies et des brûlures. Le contact accidentel de l'électrode avec des objets métalliques peut provoquer des étincelles, une explosion, un surchauffement ou un incendie. Avant de commencer le soudage, vérifier et s'assurer que l'endroit ne présente pas de danger.

- Déplacer toutes les substances inflammables à une distance de 10,7 m de l'arc de soudage. En cas d'impossibilité les recouvrir soigneusement avec des protections homologués.
- Ne pas souder dans un endroit où des étincelles peuvent tomber sur des substances inflammables.
- Se protéger et d'autres personnes de la projection d'étincelles et de métal chaud.
- Des étincelles et des matériaux chauds du soudage peuvent facilement passer dans d'autres zones en traversant de petites fissures et des ouvertures.
- Surveiller tout déclenchement d'incendie et tenir un extincteur à proximité.
- Le soudage effectué sur un plafond, plancher, paroi ou séparation peut déclencher un incendie de l'autre côté.
- Ne pas effectuer le soudage sur des conteneurs fermés tels que des réservoirs, tambours, ou conduites, à moins qu'ils n'aient été préparés correctement conformément à AWS F4.1 (voir les normes de sécurité).
- Ne soudez pas si l'air ambiant est chargé de particules, gaz, ou vapeurs inflammables (vapeur d'essence, par exemple).
- Brancher le câble de masse sur la pièce la plus près possible de la zone de soudage pour éviter le transport du courant sur une longue distance par des chemins inconnus éventuels en provoquant des risques d'électrocution, d'étincelles et d'incendie.
- Ne pas utiliser le poste de soudage pour dégeler des conduites gelées.
- En cas de non utilisation, enlever la baguette d'électrode du porte-électrode ou couper le fil à la pointe de contact.
- Porter des vêtements de protection dépourvus d'huile tels que des gants en cuir, une chemise en matériau lourd, des pantalons sans revers, des chaussures hautes et un couvre chef.
- Avant de souder, retirer toute substance combustible de vos poches telles qu'un allumeur au butane ou des allumettes.
- Une fois le travail achevé, assurez-vous qu'il ne reste aucune trace d'étincelles incandescentes ni de flammes.
- Utiliser exclusivement des fusibles ou coupe-circuits appropriés. Ne pas augmenter leur puissance; ne pas les ponter.
- Une fois le travail achevé, assurez-vous qu'il ne reste aucune trace d'étincelles incandescentes ni de flammes.
- Utiliser exclusivement des fusibles ou coupe-circuits appropriés. Ne pas augmenter leur puissance; ne pas les ponter.
- Suivre les recommandations dans OSHA 1910.252(a)(2)(iv) et NFPA 51B pour les travaux à chaud et avoir de la surveillance et un extincteur à proximité.

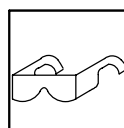

DES PIÈCES DE METAL ou DES SALETES peuvent provoquer des blessures dans les yeux.

- Le soudage, l'écaillage, le passage de la pièce à la brosse en fil de fer, et le meulage génèrent des étincelles et des particules métalliques volantes. Pendant la période de refroidissement des soudures, elles risquent de projeter du laitier.
- Porter des lunettes de sécurité avec écrans latéraux ou un écran facial.



LES ACCUMULATIONS DE GAZ risquent de provoquer des blessures ou même la mort.

- Fermer l'alimentation du gaz protecteur en cas de non-utilisation.
- Veiller toujours à bien aérer les espaces confinés ou se servir d'un respirateur d'adduction d'air homologué.



Les CHAMPS ÉLECTROMAGNÉTIQUES (CEM) peuvent affecter les implants médicaux.

- Les porteurs de stimulateurs cardiaques et autres implants médicaux doivent rester à distance.
- Les porteurs d'implants médicaux doivent consulter leur médecin et le fabricant du dispositif avant de s'approcher de la zone où se déroule du soudage à l'arc, du soudage par points, du gougeage, de la découpe plasma ou une opération de chauffage par induction.

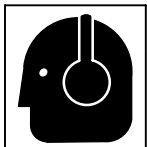

LE BRUIT peut endommager l'ouïe.

Le bruit des processus et des équipements peut affecter l'ouïe.

- Porter des protections approuvées pour les oreilles si le niveau sonore est trop élevé.

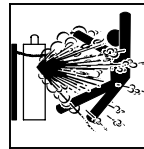

LES BOUTEILLES peuvent exploser si elles sont endommagées.

Des bouteilles de gaz protecteur contiennent du gaz sous haute pression. Si une bouteille est endommagée, elle peut exploser. Du fait que les bouteilles de gaz font normalement partie du procédé de soudage, les manipuler avec précaution.

- Protéger les bouteilles de gaz comprimé d'une chaleur excessive, des chocs mécaniques, des dommages physiques, du laitier, des flammes ouvertes, des étincelles et des arcs.
- Placer les bouteilles debout en les fixant dans un support stationnaire ou dans un porte-bouteilles pour les empêcher de tomber ou de se renverser.
- Tenir les bouteilles éloignées des circuits de soudage ou autres circuits électriques.
- Ne jamais placer une torche de soudage sur une bouteille à gaz.
- Une électrode de soudage ne doit jamais entrer en contact avec une bouteille.
- Ne jamais souder une bouteille pressurisée – risque d'explosion.
- Utiliser seulement des bouteilles de gaz protecteur, régulateurs, tuyaux et raccords convenables pour cette application spécifique ; les maintenir ainsi que les éléments associés en bon état.
- Détourner votre visage du détendeur-régulateur lorsque vous ouvrez la soupape de la bouteille.
- Le couvercle du détendeur doit toujours être en place, sauf lorsque la bouteille est utilisée ou qu'elle est reliée pour usage ultérieur.
- Utiliser les équipements corrects, les bonnes procédures et suffisamment de personnes pour soulever et déplacer les bouteilles.
- Lire et suivre les instructions sur les bouteilles de gaz comprimé, l'équipement connexe et le dépliant P-1 de la CGA (Compressed Gas Association) mentionné dans les principales normes de sécurité.

2-3. Dangers supplémentaires en relation avec l'installation, le fonctionnement et la maintenance



Risque D'INCENDIE OU D'EXPLOSION.

- Ne pas placer l'appareil sur, au-dessus ou à proximité de surfaces inflammables.
- Ne pas installer l'appareil à proximité de produits inflammables.
- Ne pas surcharger l'installation électrique – s'assurer que l'alimentation est correctement dimensionnée et protégée avant de mettre l'appareil en service.

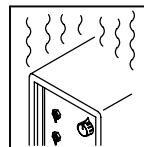

L'EMPLOI EXCESSIF peut SURCHAUFFER L'ÉQUIPEMENT.

- Prévoir une période de refroidissement ; respecter le cycle opératoire nominal.
- Réduire le courant ou le facteur de marche avant de poursuivre le soudage.
- Ne pas obstruer les passages d'air du poste.



LA CHUTE DE L'ÉQUIPEMENT peut provoquer des blessures.

- Utiliser l'anneau de levage uniquement pour soulever l'appareil, NON PAS les chariots, les bouteilles de gaz ou tout autre accessoire.
- Utiliser un équipement de levage de capacité suffisante pour lever l'appareil.
- En utilisant des fourches de levage pour déplacer l'unité, s'assurer que les fourches sont suffisamment longues pour dépasser du côté opposé de l'appareil.
- Tenir l'équipement (câbles et cordons) à distance des véhicules mobiles lors de toute opération en hauteur.
- Suivre les consignes du Manuel des applications pour l'équation de levage NIOSH révisée (Publication N°94-110) lors du levage manuel de pièces ou équipements lourds.

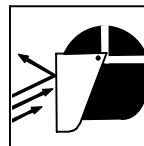

LES ÉTINCELLES PROJETÉES peuvent provoquer des blessures.

- Porter un écran facial pour protéger le visage et les yeux.
- Affûter l'électrode au tungstène uniquement à la meuleuse dotée de protecteurs. Cette manœuvre est à exécuter dans un endroit sûr lorsque l'on porte l'équipement homologué de protection du visage, des mains et du corps.
- Les étincelles risquent de causer un incendie – éloigner toute substance inflammable.

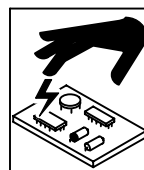

LES CHARGES ÉLECTROSTATIQUES peuvent endommager les circuits imprimés.

- Établir la connexion avec la barrette de terre avant de manipuler des cartes ou des pièces.
- Utiliser des pochettes et des boîtes antistatiques pour stocker, déplacer ou expédier des cartes de circuits imprimés.



Les PIÈCES MOBILES peuvent causer des blessures.

- Ne pas s'approcher des organes mobiles.
- Ne pas s'approcher des points de coincement tels que des rouleaux de commande.



LES FILS DE SOUDAGE peuvent provoquer des blessures.

- Ne pas appuyer sur la gâchette avant d'en avoir reçu l'instruction.
- Ne pas diriger le pistolet vers soi, d'autres personnes ou toute pièce mécanique en engageant le fil de soudage.



Les PIÈCES MOBILES peuvent causer des blessures.

- S'abstenir de toucher des organes mobiles tels que des ventilateurs.
- Maintenir fermés et verrouillés les portes, panneaux, recouvrements et dispositifs de protection.
- Lorsque cela est nécessaire pour des travaux d'entretien et de dépannage, faire retirer les portes, panneaux, recouvrements ou dispositifs de protection uniquement par du personnel qualifié.
- Remettre les portes, panneaux, recouvrements ou dispositifs de protection quand l'entretien est terminé et avant de rebrancher l'alimentation électrique.

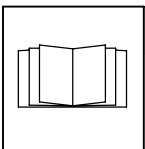

LIRE LES INSTRUCTIONS.

- Lire et appliquer les instructions sur les étiquettes et le Mode d'emploi avant l'installation, l'utilisation ou l'entretien de l'appareil. Lire les informations de sécurité au début du manuel et dans chaque section.
- N'utiliser que les pièces de rechange recommandées par le constructeur.
- Effectuer l'entretien en respectant les manuels d'utilisation, les normes industrielles et les codes nationaux, d'état et locaux.

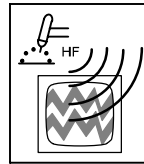

LE RAYONNEMENT HAUTE FRÉQUENCE (H.F.) risque de provoquer des interférences.

- Le rayonnement haute fréquence (H.F.) peut provoquer des interférences avec les équipements de radio-navigation et de communication, les services de sécurité et les ordinateurs.

- Demander seulement à des personnes qualifiées familiarisées avec des équipements électroniques de faire fonctionner l'installation.
- L'utilisateur est tenu de faire corriger rapidement par un électricien qualifié les interférences résultant de l'installation.
- Si le FCC signale des interférences, arrêter immédiatement l'appareil.
- Effectuer régulièrement le contrôle et l'entretien de l'installation.
- Maintenir soigneusement fermés les portes et les panneaux des sources de haute fréquence, maintenir les éclateurs à une distance correcte et utiliser une terre et un blindage pour réduire les interférences éventuelles.

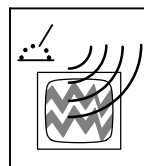

LE SOUDAGE À L'ARC risque de provoquer des interférences.

- L'énergie électromagnétique risque de provoquer des interférences pour l'équipement électronique sensible tel que les ordinateurs et l'équipement commandé par ordinateur tel que les robots.

- Veiller à ce que tout l'équipement de la zone de soudage soit compatible électromagnétiquement.
- Pour réduire la possibilité d'interférence, maintenir les câbles de soudage aussi courts que possible, les grouper, et les poser aussi bas que possible (ex. par terre).
- Veiller à souder à une distance de 100 mètres de tout équipement électronique sensible.
- Veiller à ce que ce poste de soudage soit posé et mis à la terre conformément à ce mode d'emploi.
- En cas d'interférences après avoir pris les mesures précédentes, il incombe à l'utilisateur de prendre des mesures supplémentaires telles que le déplacement du poste, l'utilisation de câbles blindés, l'utilisation de filtres de ligne ou la pose de protecteurs dans la zone de travail.

2-4. Proposition californienne 65 Avertissements

⚠ Les équipements de soudage et de coupage produisent des fumées et des gaz qui contiennent des produits chimiques dont l'État de Californie reconnaît qu'ils provoquent des malformations congénitales et, dans certains cas, des cancers. (Code de santé et de sécurité de Californie, chapitre 25249.5 et suivants)

⚠ Les batteries, les bornes et autres accessoires contiennent du plomb et des composés à base de plomb, produits chimiques dont l'État de Californie reconnaît qu'ils provoquent des cancers et des malformations congénitales ou autres problèmes de procréation. Se laver les mains après manipulation.

Pour les moteurs à essence :

⚠ Les gaz d'échappement des moteurs contiennent des produits chimiques dont l'État de Californie reconnaît qu'ils provoquent des cancers et des malformations congénitales ou autres problèmes de procréation.

Pour les moteurs diesel :

⚠ Les gaz d'échappement des moteurs diesel et certains de leurs composants sont reconnus par l'État de Californie comme provoquant des cancers et des malformations congénitales ou autres problèmes de procréation.

2-5. Principales normes de sécurité

Safety in Welding, Cutting, and Allied Processes, ANSI Standard Z49.1, de Global Engineering Documents (téléphone : 1-877-413-5184, site Internet : www.global.ihc.com).

Safe Practices for the Preparation of Containers and Piping for Welding and Cutting, American Welding Society Standard AWS F4.1, de Global Engineering Documents (téléphone : 1-877-413-5184, site internet : www.global.ihc.com).

National Electrical Code, NFPA Standard 70, de National Fire Protection Association, Quincy, MA 02269 (téléphone : 800-344-3555, site Internet : www.nfpa.org et www.sparky.org).

Safe Handling of Compressed Gases in Cylinders, CGA Pamphlet P-1, de Compressed Gas Association, 4221 Walney Road, 5th Floor, Chantilly, VA 20151 (téléphone : 703-788-2700, site Internet : www.cganet.com).

Safety in Welding, Cutting, and Allied Processes, CSA Standard W117.2, de Canadian Standards Association, Standards Sales, 5060 Spectrum Way, Suite 100, Ontario, Canada L4W 5N5 (téléphone : 800-463-6727, site internet : www.csa-international.org).

Safe Practice For Occupational And Educational Eye And Face Protection, ANSI Standard Z87.1, de American National Standards Institute,

25 West 43rd Street, New York, NY 10036 (téléphone : 212-642-4900, site Internet : www.ansi.org).

Standard for Fire Prevention During Welding, Cutting, and Other Hot Work, NFPA Standard 51B, de National Fire Protection Association, P.O. Box 9101, Quincy, MA 02269-9101 (téléphone : 617-770-3000, site Internet : www.nfpa.org).

OSHA, Occupational Safety and Health Standards for General Industry, Title 29, Code of Federal Regulations (CFR), Part 1910, Subpart Q, and Part 1926, Subpart J, de U.S. Government Printing Office, Superintendent of Documents, P.O. Box 371954, Pittsburgh, PA 15250-7954 (téléphone : 1-866-512-1800) (il y a 10 bureaux régionaux – le téléphone de la région 5, Chicago, est 312-353-2220, site Internet : www.osha.gov).

U.S. Consumer Product Safety Commission (CPSC), 4330 East West Highway, Bethesda, MD 20814 (téléphone : 301-504-7923, site internet : www.cpsc.gov).

Applications Manual for the Revised NIOSH Lifting Equation, The National Institute for Occupational Safety and Health (NIOSH), 1600 Clifton Rd, Atlanta, GA 30333 (téléphone : 1-800-232-4636, site internet : www.cdc.gov/NIOSH).

2-6. Informations relatives aux CEM

Le courant électrique qui traverse tout conducteur génère des champs électromagnétiques (CEM) à certains endroits. Le courant de soudage crée un CEM autour du circuit et du matériel de soudage. Les CEM peuvent créer des interférences avec certains implants médicaux comme des stimulateurs cardiaques. Des mesures de protection pour les porteurs d'implants médicaux doivent être prises: par exemple, des restrictions d'accès pour les passants ou une évaluation individuelle des risques pour les soudeurs. Tous les soudeurs doivent appliquer les procédures suivantes pour minimiser l'exposition aux CEM provenant du circuit de soudage:

- 1 Rassembler les câbles en les torsadant ou en les attachant avec du ruban adhésif ou avec une housse.
- 2 Ne pas se tenir au milieu des câbles de soudage. Disposer les câbles d'un côté et à distance de l'opérateur.
- 3 Ne pas courber et ne pas entourer les câbles autour de votre corps.



- 4 Maintenir la tête et le torse aussi loin que possible du matériel du circuit de soudage.
- 5 Connecter la pince sur la pièce aussi près que possible de la soudure.
- 6 Ne pas travailler à proximité d'une source de soudage, ni s'asseoir ou se pencher dessus.
- 7 Ne pas souder tout en portant la source de soudage ou le dévidoir.

En ce qui concerne les implants médicaux :

Les porteurs d'implants doivent d'abord consulter leur médecin avant de s'approcher des opérations de soudage à l'arc, de soudage par points, de gougeage, du coupage plasma ou de chauffage par induction. Si le médecin approuve, il est recommandé de suivre les procédures précédentes.

SECTION 3 – DEFINITIONS

3-1. Symbols And Definitions

A	Amperage	V	Voltage	Hz	Hertz	—	Negative
+	Positive	≡	Direct Current (DC)	1~	Single Phase	⊙	Input
⊙	Output	⊙V	Voltage Input	○	Off	 	On
⊘	Do Not Switch While Welding		Gas Metal Arc Welding (GMAW)	⊘	Wire Feed		Flux Cored Arc Welding (FCAW)

SECTION 4 – SPECIFICATIONS

4-1. Specifications

Rated Welding Output	Amperage Range	Maximum Open-Circuit Voltage DC	Amperes Input at Rated Load Output 230 V, 50/60 Hz, Single-Phase	KVA	KW	Weight W/ Gun	Overall Dimensions
130 A @ 21.5 Volts DC, 30% Duty Cycle At 60 Hz Input – 20% Duty Cycle At 50 Hz Input	25 – 185	31	20.5	4.7	3.88	68 lb (31 kg)	Length: 19-1/2 in. (495 mm) Width: 10-5/8 in. (270 mm) Height: 12-3/8 in. (314 mm)
Wire Type And Diameter	Solid/ Stainless	Flux Cored	Aluminum	Wire Feed Speed Range			
	.023 – .035 in. (0.6 – 0.9 mm)	.030 – .045 in. (0.8 – 1.2 mm)	.030 – .035 in. (0.8 – 0.9 mm)	50 – 740 IPM (1.3 – 18.8 m/min) At No Load 40 – 700 IPM (1.0 – 17.8 m/min) Feeding Wire			

4-2. Duty Cycle And Overheating

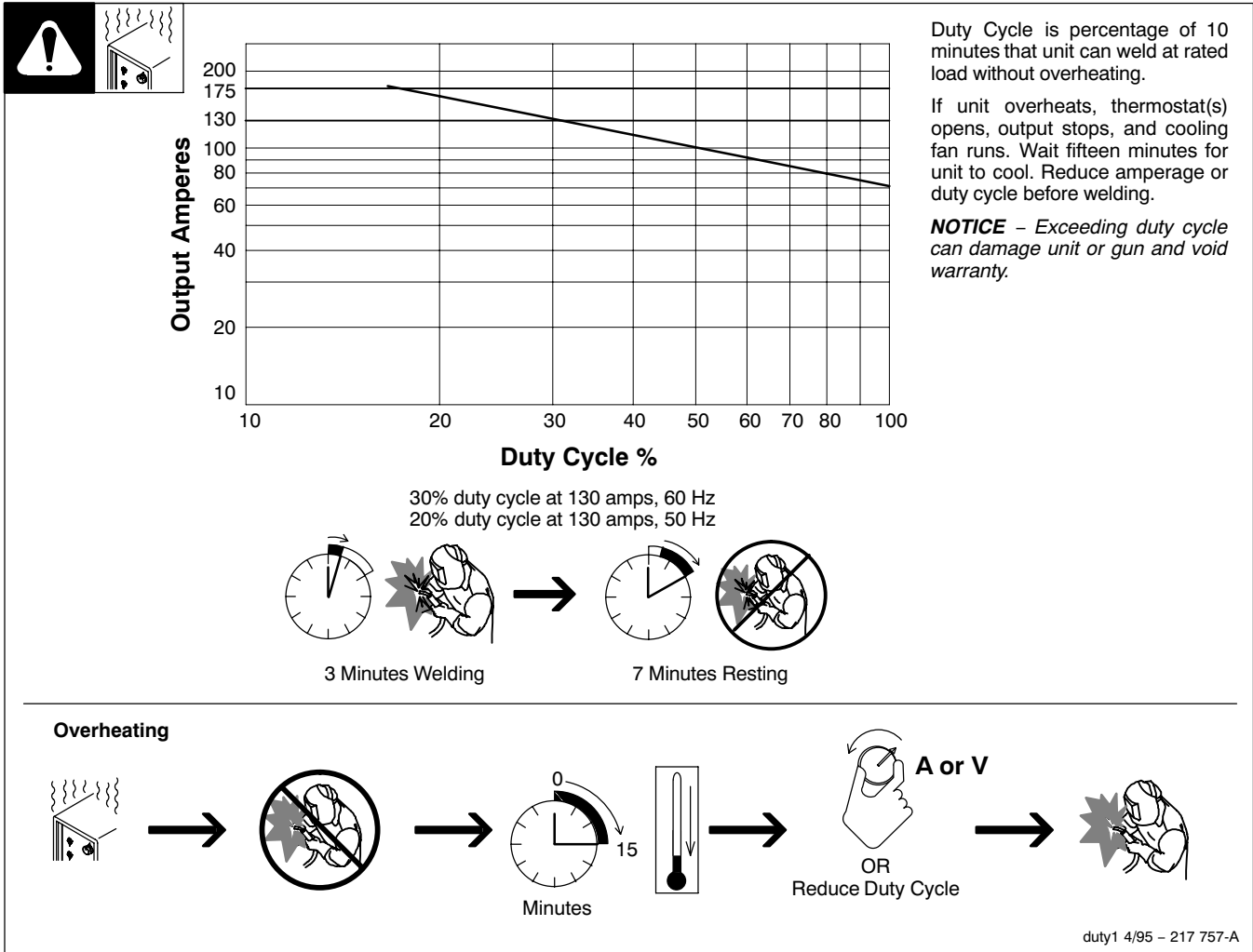

4-3. Volt-Ampere Curves

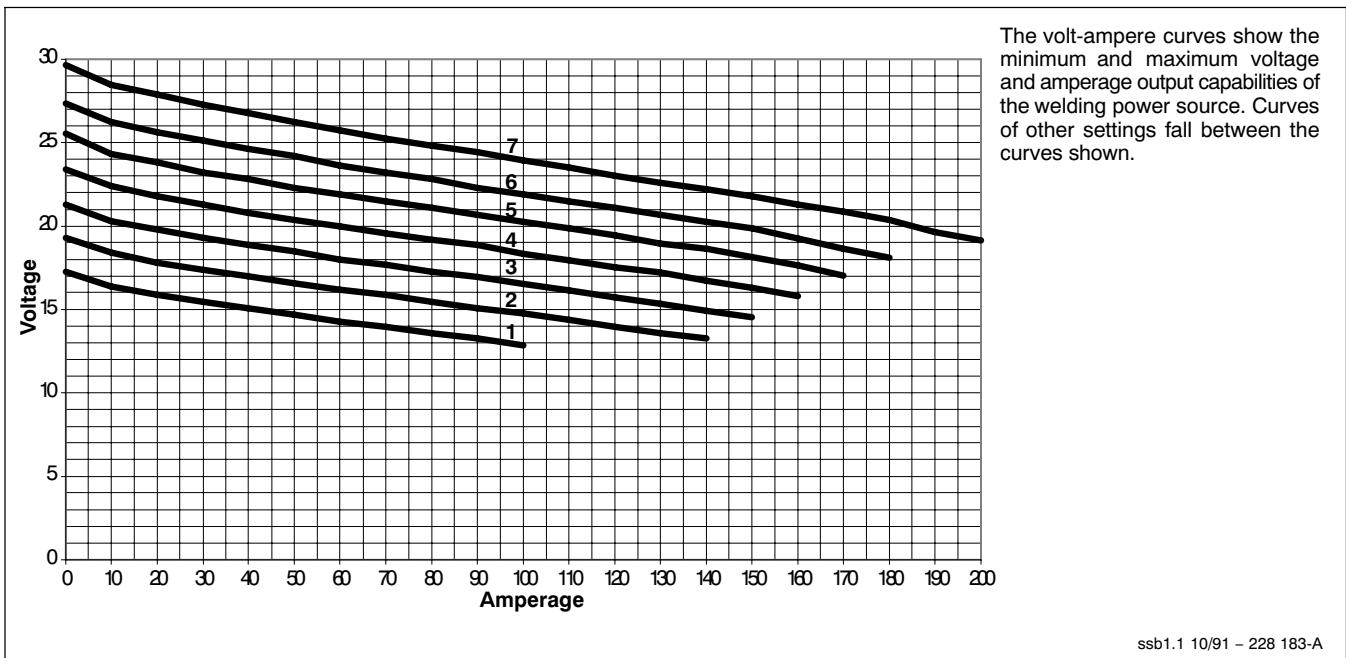

SECTION 5 – INSTALLATION

5-1. Installing Nozzle, Contact Tip, And Adapter



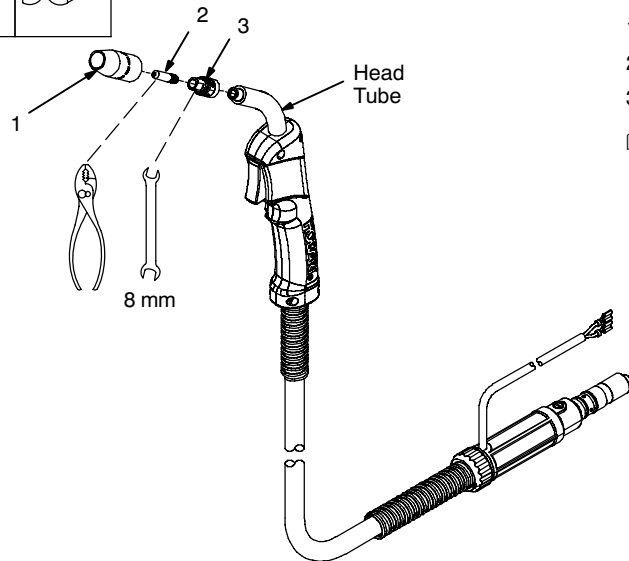



⚠ Turn off welding power source.

- 1 Nozzle
- 2 Contact Tip
- 3 Tip Adapter

☞ Wire size stamped on tip – check and match wire size.

Tools Needed:

246 669-A

5-2. Installing Welding Gun



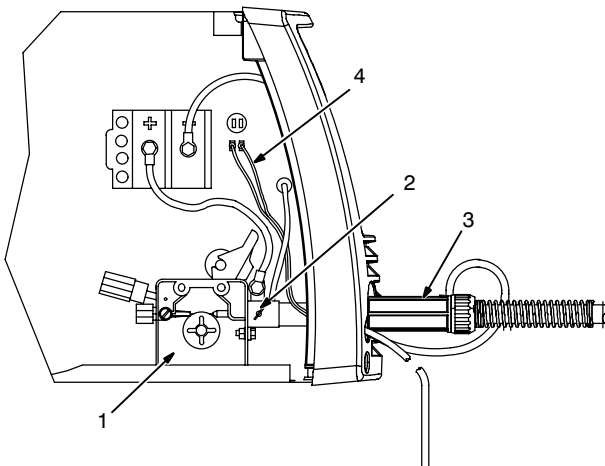

- 1 Drive Assembly
- 2 Gun Securing Thumbscrew
- 3 Gun End

Loosen thumbscrew. Insert end through opening until it bottoms against drive assembly. Tighten thumbscrew.

Welding gun must be inserted completely to prevent leakage of shielding gas.

4 Gun Trigger Leads

Insert leads, one at a time, through gun opening on front panel. Connect female friction terminals to matching male terminals in unit. Polarity is not important.

Close door.

☞ Be sure that gun end is tight against drive assembly.

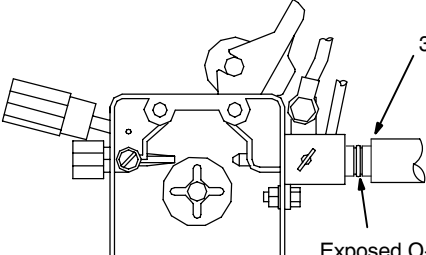

**Incorrect
Gun Not Seated**

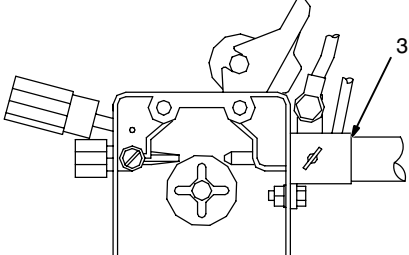

**Correct
Gun Fully Seated**

Exposed O-rings will cause shielding gas leakage.

804 621-A

5-3. Installing Work Clamp



⚠ Connection hardware must be tightened with proper tools. Do not just hand tighten hardware. A loose electrical connection will cause poor weld performance and excessive heating of the work clamp.

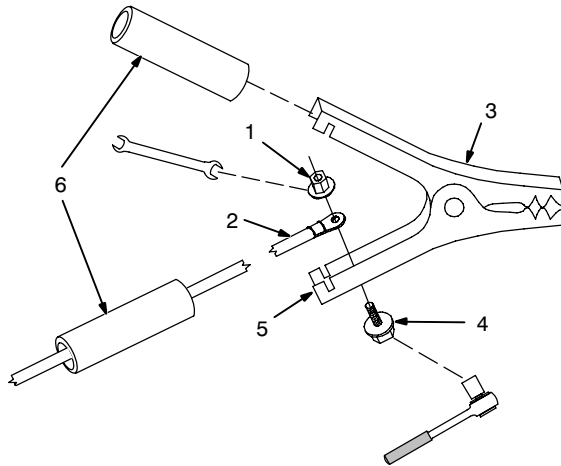

- 1 Nut
- 2 Work Cable From Unit
- 3 Work Clamp
- 4 Screw
- 5 Work Clamp Tabs

Bend tabs around work cable.

- 6 Insulating Sleeves

Slide one insulating sleeve over work cable before connecting to clamp.

Slide insulating sleeves over handles.

Tools Needed:

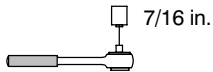

802 456-A

5-4. Process/Polarity Table

Process	Polarity	Cable Connections	
		Cable To Gun	Cable To Work
GMAW – Solid wire with shielding gas	DCEP – Reverse polarity	Connect to positive (+) output terminal	Connect to negative (-) output terminal
FCAW – Self-shielding wire – no shielding gas	DCEN – Straight Polarity	Connect to negative (-) output terminal	Connect to positive (+) output terminal

5-5. Changing Polarity



⚠ Connection hardware must be tightened with proper tools. Do not just hand tighten hardware. A loose electrical connection will cause poor weld performance and excessive heating at the terminal block.

CHANGING POLARITY

DCEN
Electrode negative for flux cored wire

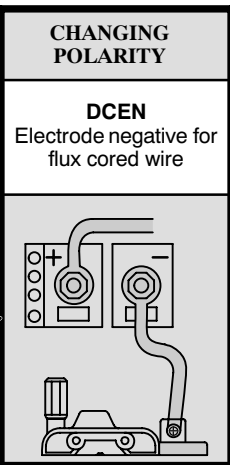

1 →

DCEP
Electrode positive for solid wire

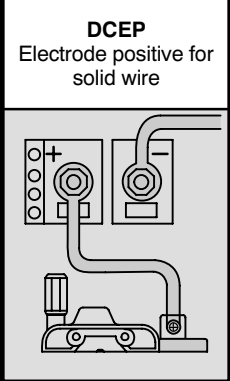

← 2

⚠ Turn off welding power source.

- 1 Lead Connections For Direct Current Electrode Negative (DCEN)
- 2 Lead Connections For Direct Current Electrode Positive (DCEP)

Always read and follow wire manufacturer's recommended polarity, and see Section 5-4.
Close door.

Ref. 209 228 / Ref. 209 229

5-6. Installing Gas Supply



DO NOT use Argon/Mixed gas regulator/flowmeter with CO₂ shielding gas. See Parts List for optional CO₂ gas regulator/flowmeter.

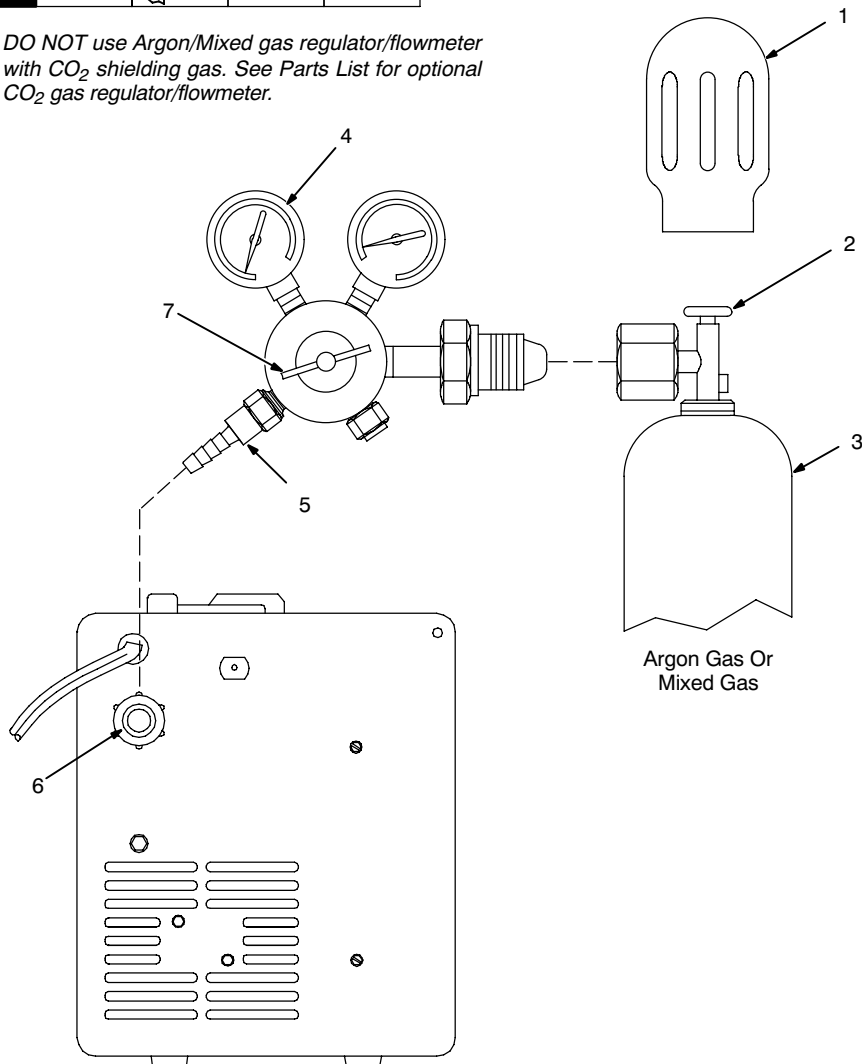

Obtain gas cylinder and chain to running gear, wall, or other stationary support so cylinder cannot fall and break off valve.

- 1 Cap
- 2 Cylinder Valve

Remove cap, stand to side of valve, and open valve slightly. Gas flow blows dust and dirt from valve. Close valve.

- 3 Cylinder
- 4 Regulator/Flowmeter

Install so face is vertical.

- 5 Regulator/Flowmeter Gas Hose Connection
- 6 Welding Power Source Gas Hose Connection

Connect supplied gas hose between regulator/flowmeter gas hose connection, and fitting on rear of welding power source.

- 7 Flow Adjust

Flow rate should be set when gas is flowing through welding power source and welding gun. Open feedhead pressure assembly so that wire will not feed. Press gun trigger to start gas flow.

Typical flow rate is 20 cfh (cubic feet per hour). Check wire manufacturer's recommended flow rate.

After flow is set, close feedhead pressure assembly.

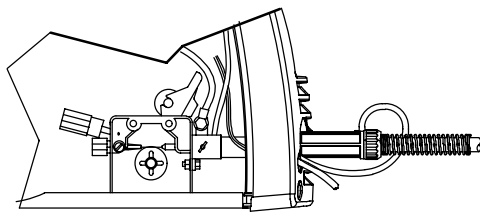

Feedhead Pressure Assembly Open

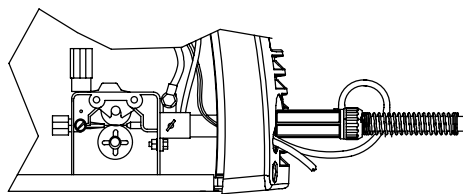

Feedhead Pressure Assembly Closed

Tools Needed:

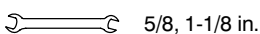

5/8, 1-1/8 in.

5-7. Selecting A Location And Connecting Input Power

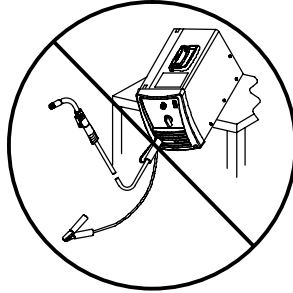
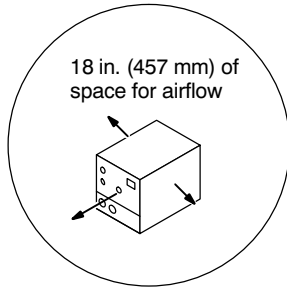
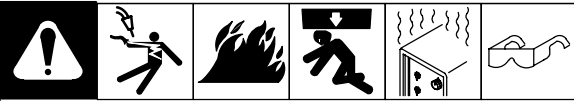

⚠ Do not move or operate unit where it could tip.

⚠ Special installation may be required where gasoline or volatile liquids are present – see NEC Article 511 or CEC Section 20.

⚠ Installation must meet all National and Local Codes – have only qualified persons make this installation.

⚠ Disconnect and lockout/tag-out input power before connecting input conductors from unit.

⚠ Always connect green or green/yellow conductor to supply grounding terminal first, and never to a line terminal.

1 Rating Label

Supply correct input power.

2 Black And White Input Conductor (L1 And L2)

3 Green Or Green/Yellow Grounding Conductor

4 Input Power Cord.

5 Disconnect Device (switch shown in the OFF position)

6 Disconnect Device Grounding Terminal

7 Disconnect Device Line Terminals

Connect green or green/yellow grounding conductor to disconnect device grounding terminal first.

Connect input conductors L1 and L2 to disconnect device line terminals.

8 Receptacle (NEMA 6-50R)

Connect receptacle as shown.

9 Over-Current Protection

Select type and size of over-current protection using Section 5-8 (fused disconnect switch shown).

Close and secure door on disconnect device. Remove lockout/tagout device, and place switch in the On position.

10 Plug (NEMA 6-50P)

Connect plug to receptacle.

= GND/PE Earth Ground

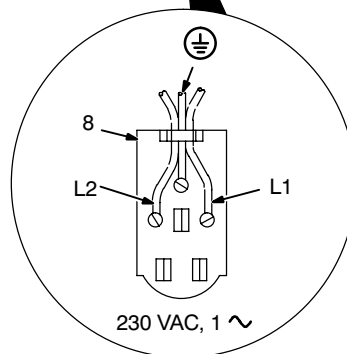
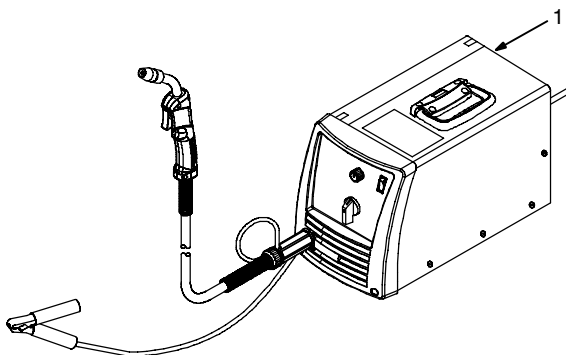
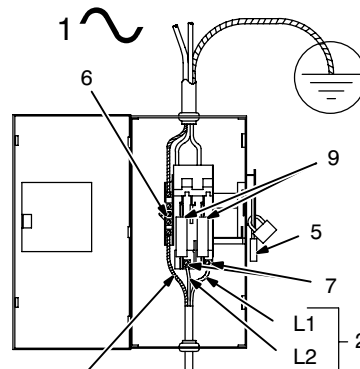

ssb2.2* 1/94 – 804 622-B

5-8. Electrical Service Guide



⚠ Failure to follow these electrical service guide recommendations could create an electric shock or fire hazard. These recommendations are for a dedicated branch circuit sized for the rated output and duty cycle of the welding power source.

Input Voltage (V)	230
Input Amperes (A) At Rated Output	20.5
Max Recommended Standard Fuse Or Circuit Breaker Rating In Amperes	
Circuit Breaker ¹ , Time-Delay Fuses ²	25
Normal Operating Fuses ³	30
Min Input Conductor Size In AWG	14
Max Recommended Input Conductor Length In Feet (Meters)	67 (20)
Min Grounding Conductor Size In AWG	14

Reference: 2008 National Electrical Code (NEC) (including article 630)

- 1 If a circuit breaker is used in place of a fuse, choose a circuit breaker with time-current curves comparable to the recommended fuse.
- 2 "Time-Delay" fuses are UL class "RK5" . See UL 248.
- 3 "Normal Operating" (general purpose - no intentional delay) fuses are UL class "K5" (up to and including 60 amps), and UL class "H" (65 amps and above).
- 4 Conductor data in this section specifies conductor size (excluding flexible cord or cable) between the panelboard and the equipment per NEC Table 310.16. If a flexible cord or cable is used, minimum conductor size may increase. See NEC Table 400.5(A) for flexible cord and cable requirements.

5-9. Installing Wire Spool And Adjusting Hub Tension

Installing 4 in. (102 mm) Wire Spool



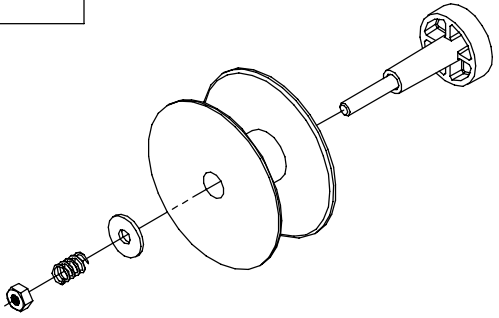

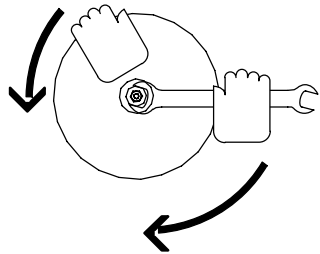
When a slight force is needed to turn spool, tension is set.

Installing 8 in. (203 mm) Wire Spool

Adapter used with 8 in. (203 mm) spool only.

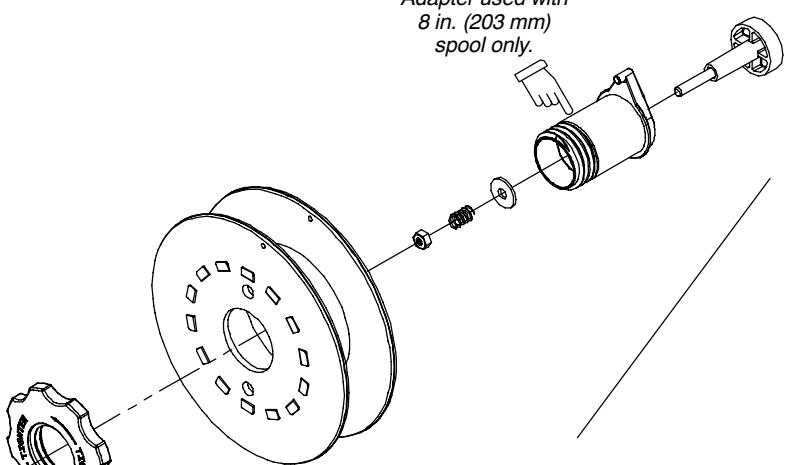

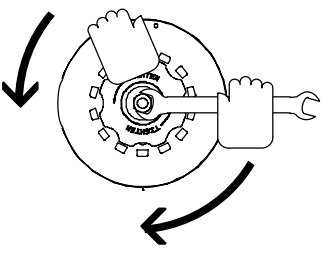

Retaining ring used with 8 in. (203 mm) spool only.



When a slight force is needed to turn spool, tension is set.

Tools Needed:

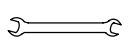

1/2 in.

803 012 / 803 013 -B / Ref. 802 971-C

5-10. Threading Welding Wire



- 1 Wire Spool
 - 2 Welding Wire
 - 3 Inlet Wire Guide
 - 4 Pressure Adjustment Knob
 - 5 Drive Roll
 - 6 Gun Conduit Cable
- Lay gun cable out straight.

Tools Needed:

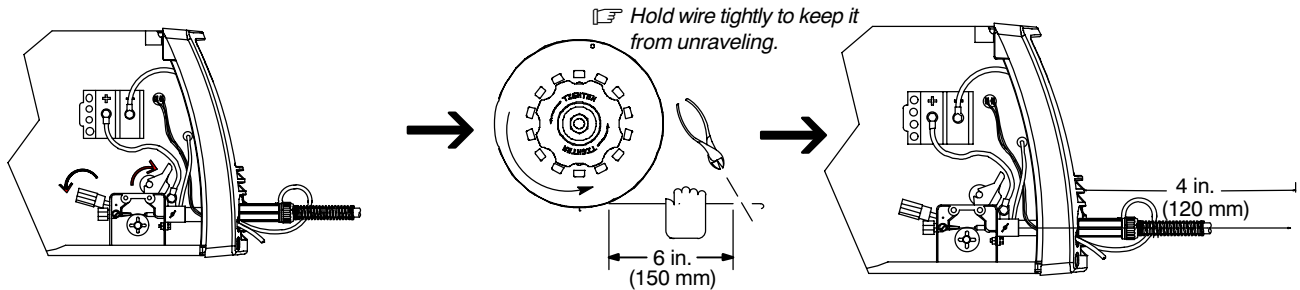
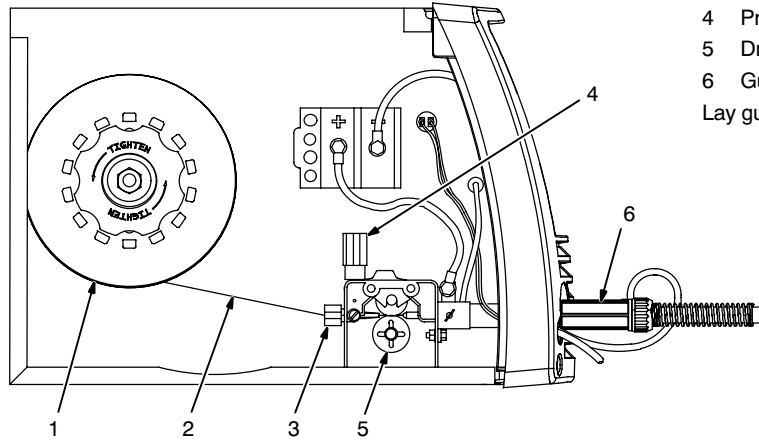
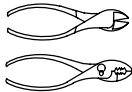

Open pressure assembly. Make sure feed roll is set to correct groove to match wire size (see Section 7-4).

Pull and hold wire; cut off end.

Push wire thru guides into gun; continue to hold wire.

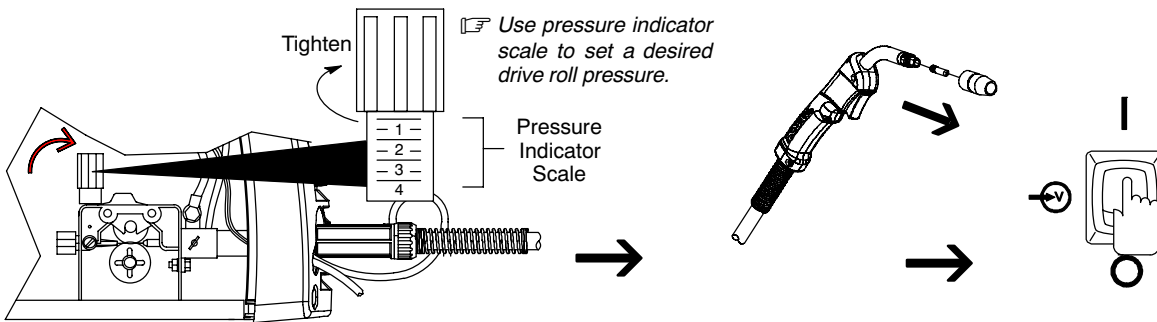

Be sure that wire is positioned in proper drive roll groove and wire is laying in the groove.

Close and tighten pressure assembly, and let go of wire.

Remove gun nozzle and contact tip.

Turn power on. Be sure that Voltage range switch is set to range 1, 2, 3, 4, 5, 6, or 7 to feed wire. Rotate knob until it "clicks" into detent. Wire will not feed if range switch is set between ranges.

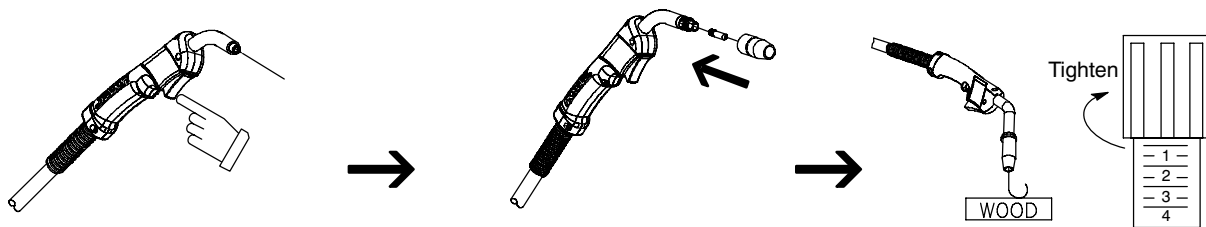

Press gun trigger until wire comes out of gun.

Be sure that tip matches wire diameter. Reinstall contact tip and nozzle.

Feed wire to check drive roll pressure. Tighten knob enough to prevent slipping. Cut off wire. Close door.

SECTION 6 – OPERATION

6-1. Controls

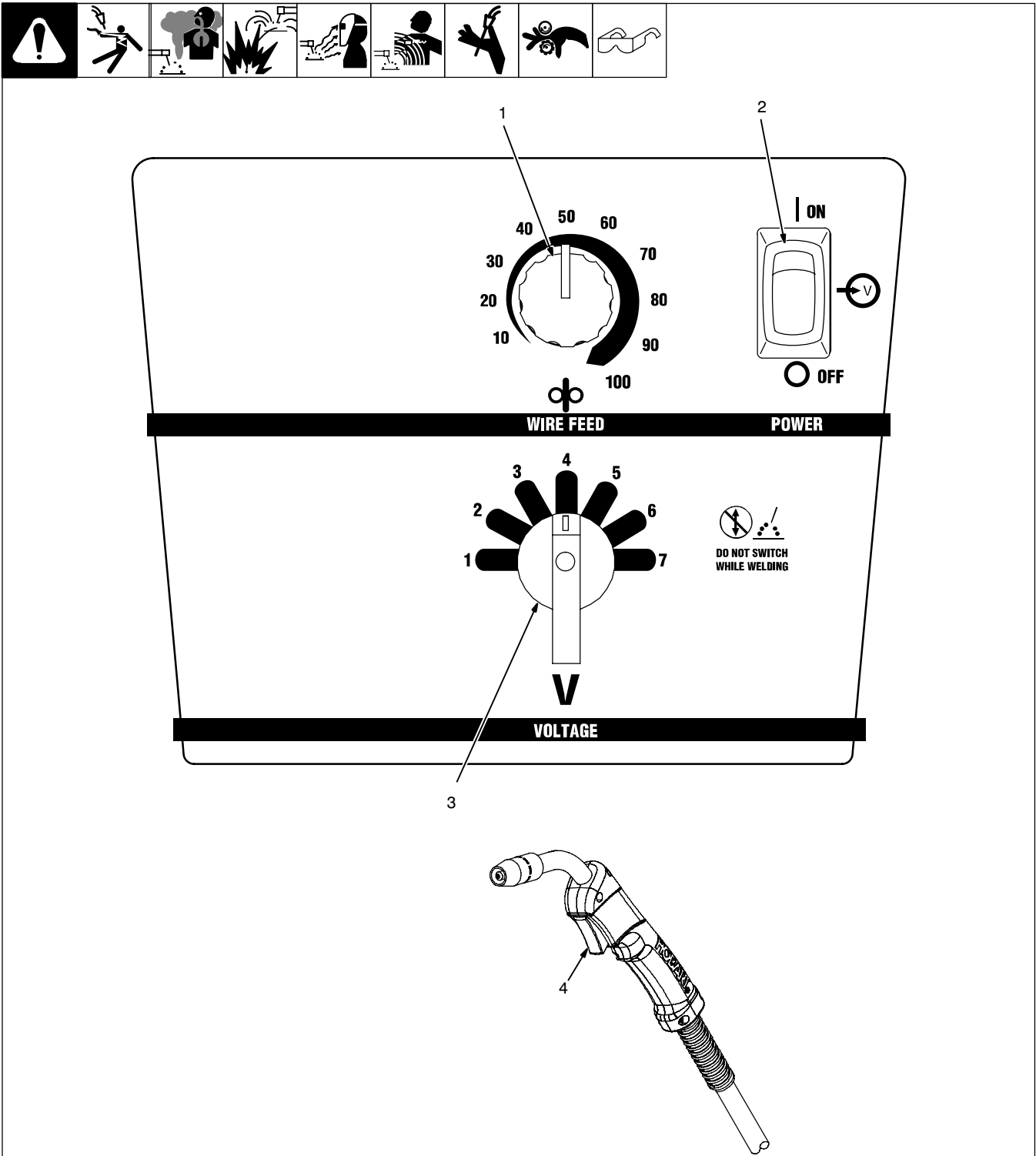

Ref. 228 178-A / Ref. 246 668-A

1 Wire Speed Control

Use control to select a wire feed speed. As Voltage switch setting increases, wire speed range also increases (see weld setting label in welding power source or Section 6-2, as applicable).

2 Power Switch

3 Voltage Switch

The higher the selected number, the thicker the material that can be welded (see weld setting label in welding power source or Section 6-2, as applicable). Do not switch under load.

 Switch must "click" into detent position.

4 Trigger Switch

When pressed, energized wire feeds and shielding gas flows.

6-2. Weld Parameter Chart

Welding Guide for 230 Volt						
Settings are approximate. Adjust as required. Thicker materials can be welded using proper technique, joint preparation and multiple passes.						
Material Being Welded	Wire Type and Polarity Setting	Suggested Shielding Gas 20-30 CFH Flow Rate	Diameter of Wire Being Used	24 ga. .024 in. (0.6 mm)	20 ga. .036 in. (0.8 mm)	
Steel	Flux Cored E71T-11 "Set Polarity for (DCEN)"	No Shielding Gas Required Good for windy or outdoor applications	.030" (0.8 mm)	~	1/35	
			.035" (0.9 mm)	~	1/30	
			.045" (1.2 mm)	~	~	
Steel	Solid Wire ER70S-6 "Set Polarity for (DCEP)"	C ₂₅ Gas Mixture 75% Argon / 25% CO ₂ Produces less spatter. Better appearance	.024" (0.6 mm)	1/30	2/40	
			.030" (0.8 mm)	~	1/40	
			.035" (0.9 mm)	~	3/40	
Steel	Solid Wire ER70S-6 "Set Polarity for (DCEP)"	100% CO ₂	.024" (0.6 mm)	~	~	
			.030" (0.8 mm)	~	~	
			.035" (0.9 mm)	~	~	
Stainless Steel	Stainless Steel "Set Polarity for (DCEP)"	Tri-Mix 90% He/7.5% Ar/2.5% CO ₂	.024" (0.6 mm)	~	3/40	
			.030" (0.8 mm)	~	3/30	
			.035" (0.9 mm)	~	3/15	
Aluminum	Aluminum** "Set Polarity for (DCEP)"	100% Argon**	.030" (0.8 mm)	~	~	
			.035" (0.9 mm)	~	~	
Match feedroll groove to diameter of wire being used. Set Tension Knob Setting to 3 at start. Adjust tension per instructions in the manual.			CAUTION! Do not change Voltage switch position while welding. See owners manual for more information.			
*Multiple passes required.		**Aluminum wire is soft so feedability is not as good.				

Wire Welding Package

Recommended Voltage and Wire Speed Settings for thickness of metal being welded.
Number on left of slash is Voltage Setting / Number on right of slash is Wire Feed Setting.

	18 ga. .048 in. (1.2 mm)	16 ga. .060 in. (1.6 mm)	11 ga. 1/8 inch (3.2 mm)	3/16 inch (4.8 mm)	1/4 inch (6.4 mm)	5/16 inch (8.0 mm)
	1/40	2/40	4/60	5/40	6 / 40*	~
	1/35	2/40	3/50	5/50	6/60	7 / 60*
	~	1/25	3/30	4/35	5/35	6 / 35*
	3/50	4/60	5/80	6/90	~	~
	2/50	3/50	5/60	6/60	6 / 70*	7 / 80*
	4/40	5/40	5/50	6/50	7 / 50*	7 / 60*
	3/35	5/40	5/60	6/80	7 / 90*	~
	4/40	5/40	5/50	6/50	7 / 50*	7 / 50*
	3/25	4/25	5/40	6/40	7 / 40*	7 / 40*
	3/40	4/50	6/60	7/70	~	~
	3/35	4/30	5/35	6/50	7 / 50*	~
	3/35	4/30	5/40	7/40	7 / 50*	~
	~	2/90	6/90	7/90	~	~
	~	2 / 100	6/90	7/90	~	~

Wire Speed listed is a starting value only. Wire Speed setting can be fine-tuned while welding. Wire Speed also depends on other variables such as stick out, travel speed, weld angle, cleanliness of metal, etc.

Make sure that hub tension is not too tight and keep the torch straight as possible. A "push angle" for the torch is recommended.

CHANGING POLARITY

DCEN

Electrode Negative
For Flux Cored Wire

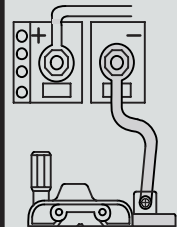

DCEP



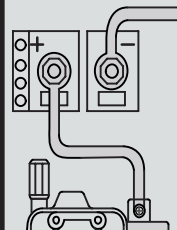







Electrode Positive
For Solid Wire

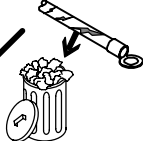

227010

SECTION 7 – MAINTENANCE & TROUBLESHOOTING

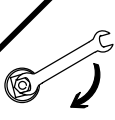
7-1. Routine Maintenance

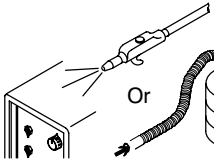
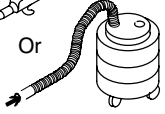
	 Disconnect power before maintaining.
 3 Months	
Replace unreadable labels. 	
Repair or replace cracked weld cable. 	
	Clean and tighten weld terminals. 
	
 6 Months	
Blow out or vacuum inside. During heavy service, clean monthly. 	Or 

7-2. Overload Protection

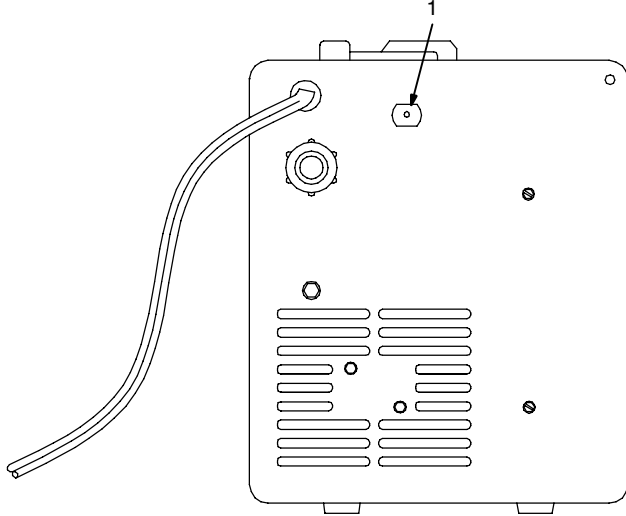
	
	<p>1 Supplementary Protector CB1 CB1 protects unit from overload. If CB1 opens, unit shuts down. Reset supplementary protector.</p>
	802 441

7-3. Drive Motor Protection

Drive motor protection circuit protects drive motor from overload. If drive motor becomes inoperative, release gun trigger and wait until protection circuit resets allowing drive motor to feed wire again.

7-4. Changing Drive Roll Or Wire Inlet Guide

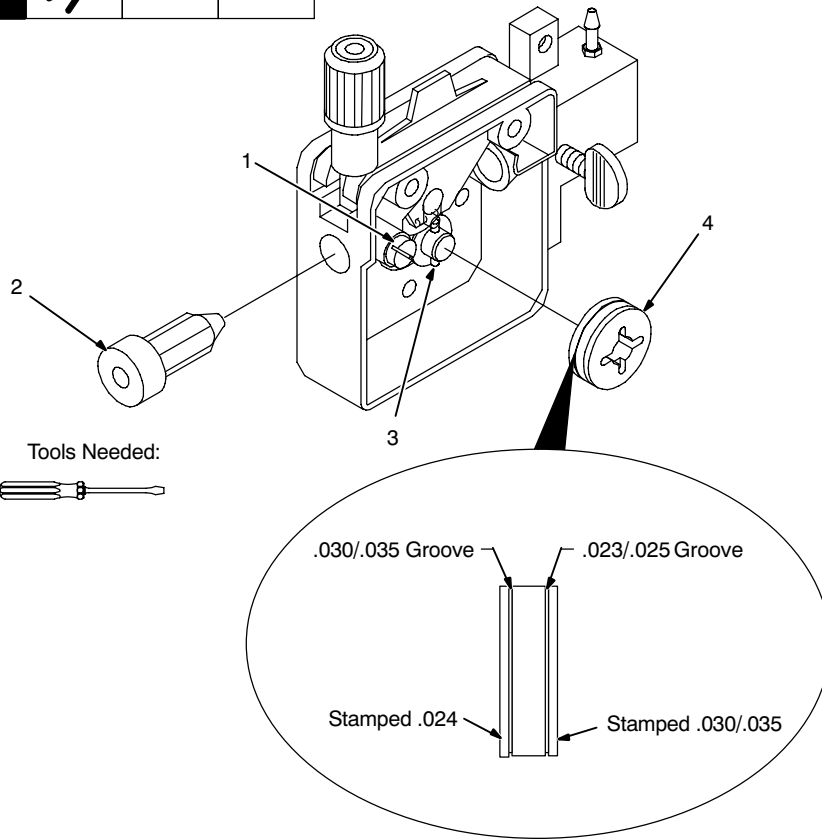

⚠ Turn off welding power source.

1 Inlet Wire Guide Securing Screw

2 Inlet Wire Guide

Loosen screw. Slide tip as close to drive rolls as possible without touching. Tighten screw.

3 Retaining Pin

To remove drive roll, push drive roll in and rotate it (1/4 turn) to the open slot and slide it out over the retaining pin.

To secure drive roll, locate open slot and push drive roll completely over retaining pin, then rotate drive roll (1/4 turn) to closed slot.

4 Drive Roll

The drive roll consists of two different sized grooves. The stamped markings on the end surface of the drive roll refers to the groove on the opposite side of the drive roll. The groove closest to the motor shaft is the proper groove to thread (see Section 5-10).

Ref. 803 714-A

7-5. Changing Nozzle, Contact Tip, Adapter And Liner, And Cleaning Gun Casing

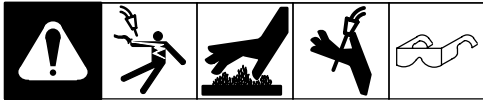

⚠ Turn off welding power source.

- 1 Nozzle
- 2 Contact Tip
- 3 Tip Adapter

🔧 Wire size stamped on tip – check and match wire size.

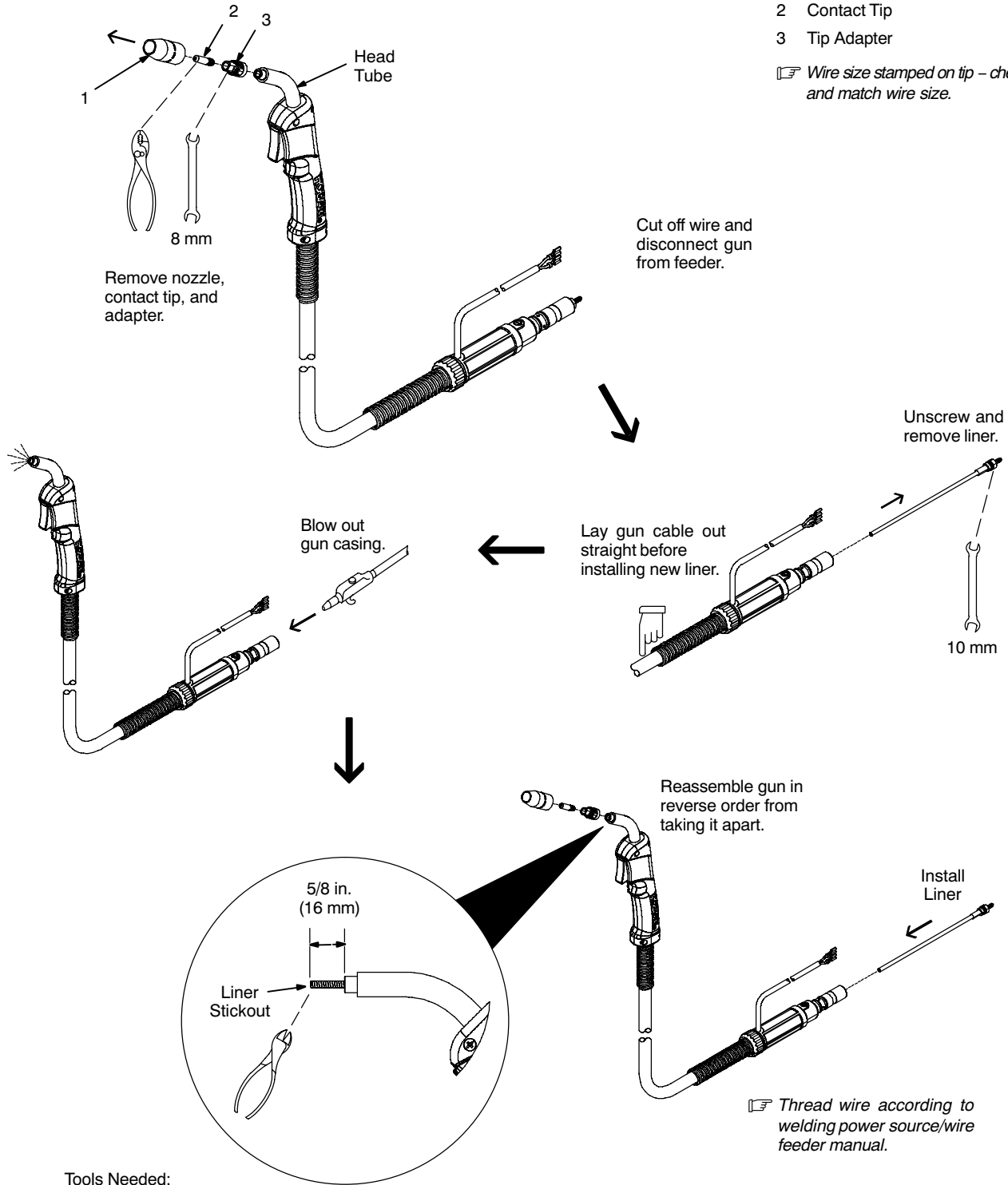

Tools Needed:

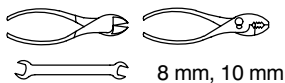

8 mm, 10 mm

246 669-A

7-6. Replacing Switch And/Or Head Tube



Turn Off welding power source /wire feeder and disconnect gun.

1 Remove screws (5) and nuts (4).

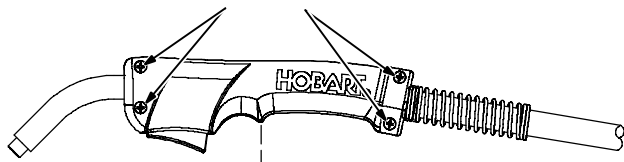

Remove screw on opposite side.

2 Remove handle halves.

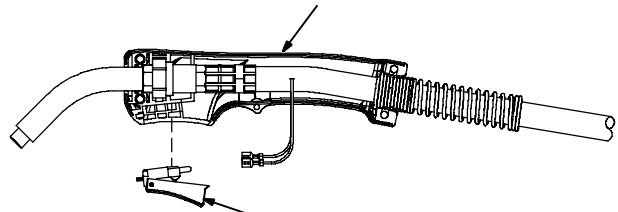

3 Remove switch housing. Install new switch and connect leads (polarity is not important). Reassemble in reverse order. If replacing head tube, continue to end of figure.

4 Secure head tube in vice.

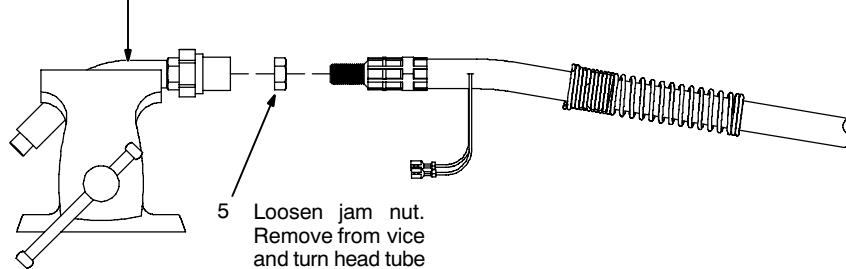

5 Loosen jam nut. Remove from vice and turn head tube out by hand.

6 Hand-tighten head tube into cable connector.

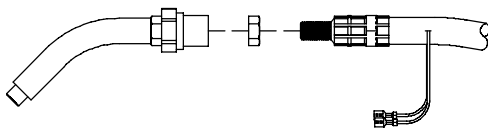

7 Place head tube in vice and tighten until nuts are tight.

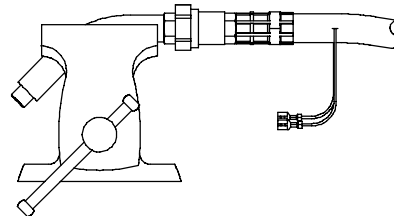

8 Remove from vice. Reposition handle halves, and install switch housing.

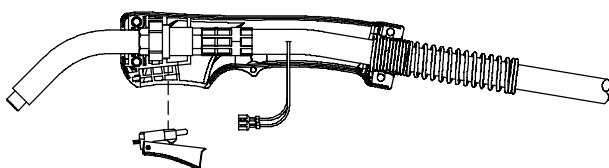

9 Reinstall screws and nuts.

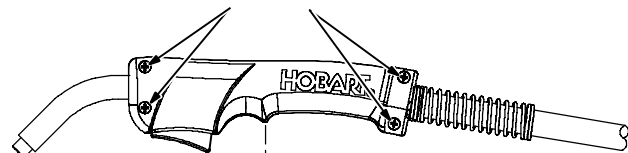

Reinstall screw on opposite side.

Tools Needed:



243 840-A

7-7. Troubleshooting Table



Trouble	Remedy
No weld output; wire does not feed; fan does not run.	Secure power cord plug in receptacle (see Section 5-7).
	Replace building line fuse or reset circuit breaker if open.
	Place Power switch in On position (see Section 6-1).
	Reset welding power source supplementary protector (see Section 7-2).
No weld output; wire does not feed; fan motor continues to run.	Thermostat TP1 open (overheating). Allow fan to run with gun trigger switch off; thermostat closes when unit has cooled (see Section 4-2).
	Check Voltage range switch position. Rotate knob until it “clicks” into detent at desired range setting.
	Secure gun trigger leads (see Section 5-2).
No weld output; wire feeds.	Connect work clamp to get good metal to metal contact.
	Replace contact tip (see Section 7-5).
	Check for proper polarity connections (see Section 5-5).
	Check thumbscrew securing gun end to feed head adapter and tighten if necessary.
Wire does not feed; wire is not energized; wire feeds unevenly.	Check contact tip. Check for kinks in gun cable and liner.
	Check gun trigger plug connection at welding power source/wire feeder.
	Check, and if necessary, replace gun trigger switch (see Section 7-6).
	Check contact tip. Check for kinks in gun cable. Blow out liner and gun casing (see Section 7-5).
Low weld output.	Connect unit to proper input voltage or check for low line voltage.
	Place voltage switch in desired position (see Section 6-1).
Electrode wire feeding stops during welding.	Straighten gun cable and/or replace damaged parts.
	Adjust drive roll pressure (see Section 5-10).
	Change to proper drive roll groove (see Section 7-4).
	Readjust hub tension (see Section 5-9).
	Be sure that wire is positioned in proper drive roll groove and wire is laying in the groove.
	Replace contact tip if blocked (see Section 7-5).
	Clean or replace wire inlet guide or liner if dirty or plugged (see Section 7-4 or Section 7-5).
	Replace drive roll or pressure bearing if worn or slipping (see Section 7-4).
	Secure gun trigger leads or repair leads (see Section 5-2).
	Check and clear any restrictions at drive assembly and liner (see Section 5-10 or Section 7-5).
	Release gun trigger and allow gun and motor protection circuitry to reset (see Section 7-3).
Weld porosity.	Remove weld spatter buildup in nozzle.
	Check O-rings on gun connector and replace if damaged.
	Make sure inner head tube is tight in cable connector.
	Check gun connector to be sure it is fully inserted into drive assembly.
	Check shielding gas flow/supply.

SECTION 8 – ELECTRICAL DIAGRAM

	WARNING
	<ul style="list-style-type: none"> • Do not touch live electrical parts. • Disconnect input power or stop engine before servicing. • Do not operate with covers removed. • Have only qualified persons install, use, or service this unit.
ELECTRIC SHOCK HAZARD	

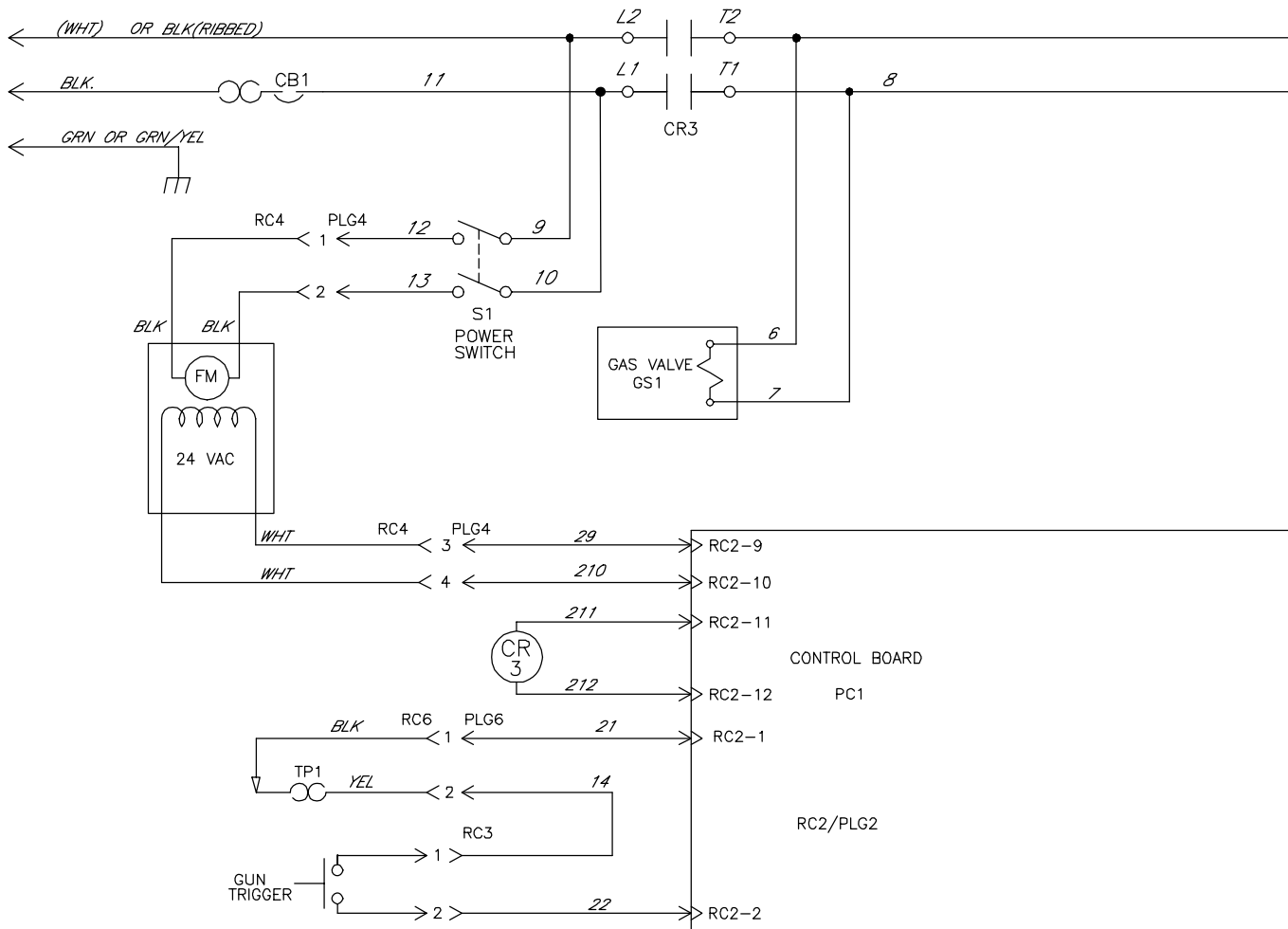

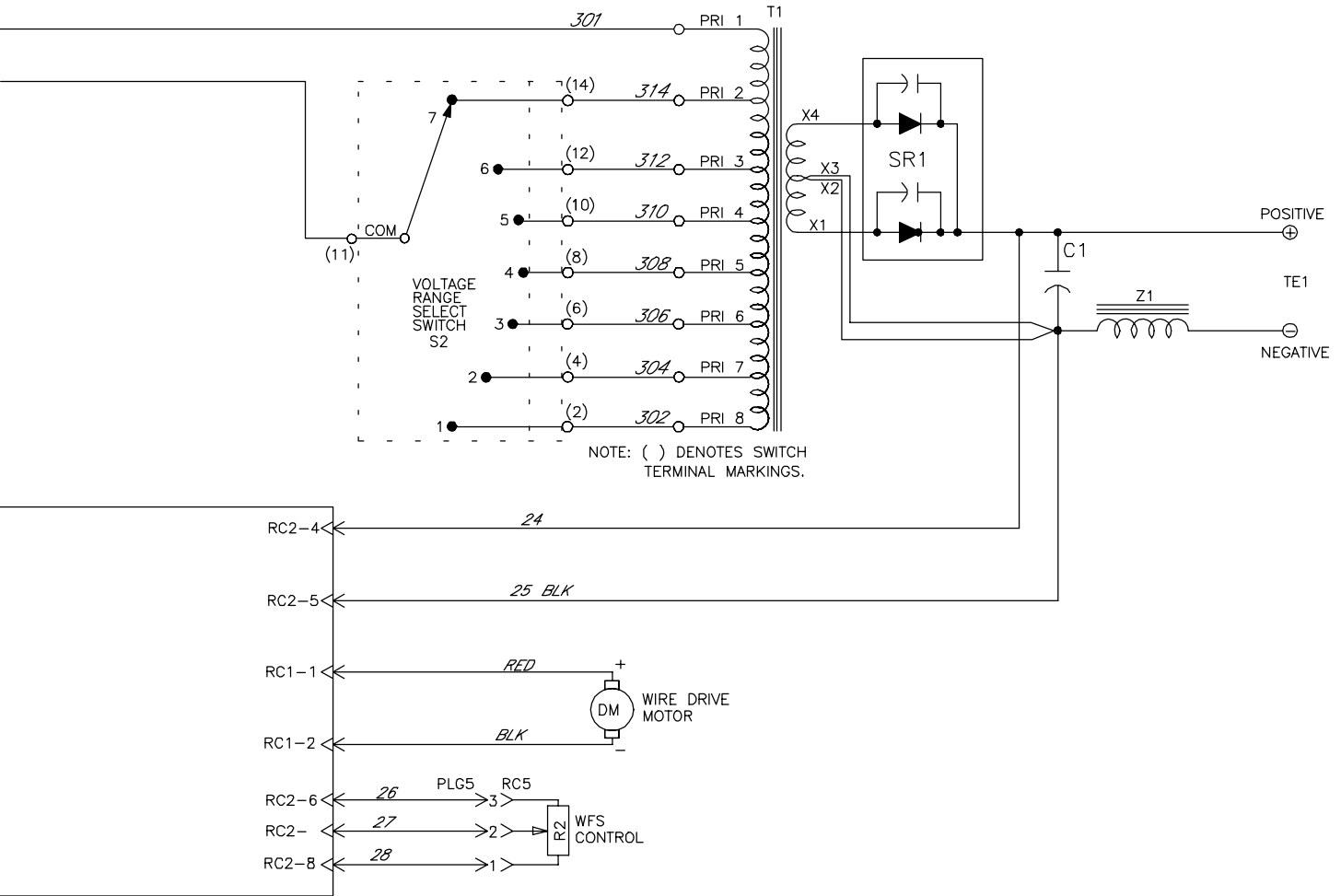
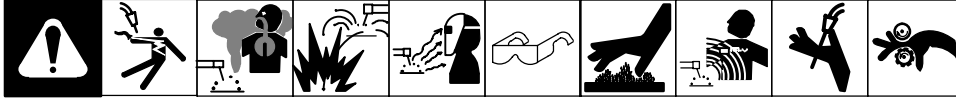

Figure 8-1. Circuit Diagram

	WARNING
	<ul style="list-style-type: none"> • Do not touch live electrical parts. • Disconnect input power or stop engine before servicing. • Do not operate with covers removed. • Have only qualified persons install, use, or service this unit.
ELECTRIC SHOCK HAZARD	



SECTION 9 – MIG WELDING (GMAW) GUIDELINES



mig1_2009-12 / Ref. 801 909-A

9-1. Typical MIG Process Connections

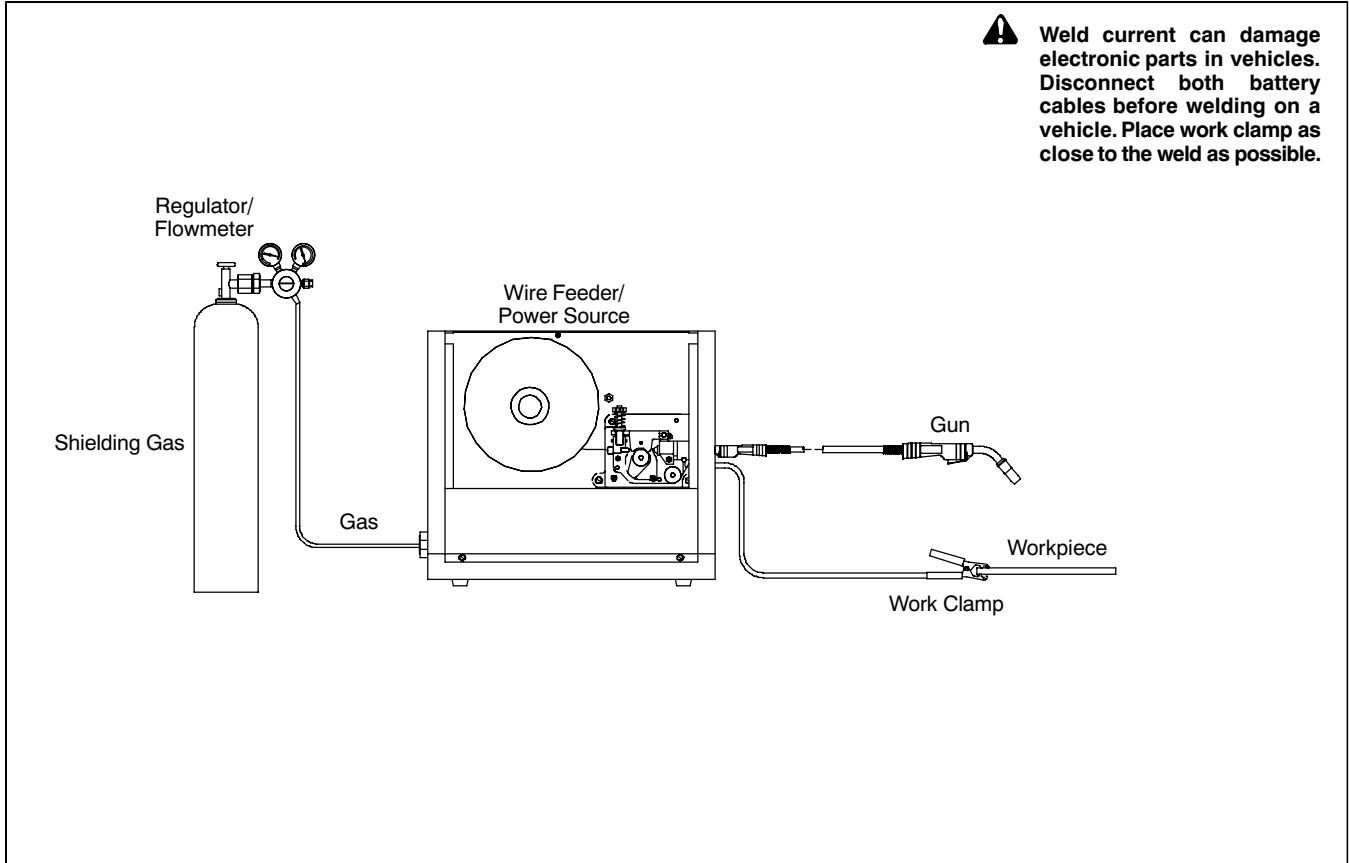

9-2. Typical MIG Process Control Settings

 These settings are guidelines only. Material and wire type, joint design, fitup, position, shielding gas, etc. affect settings. Test welds to be sure they comply to specifications.

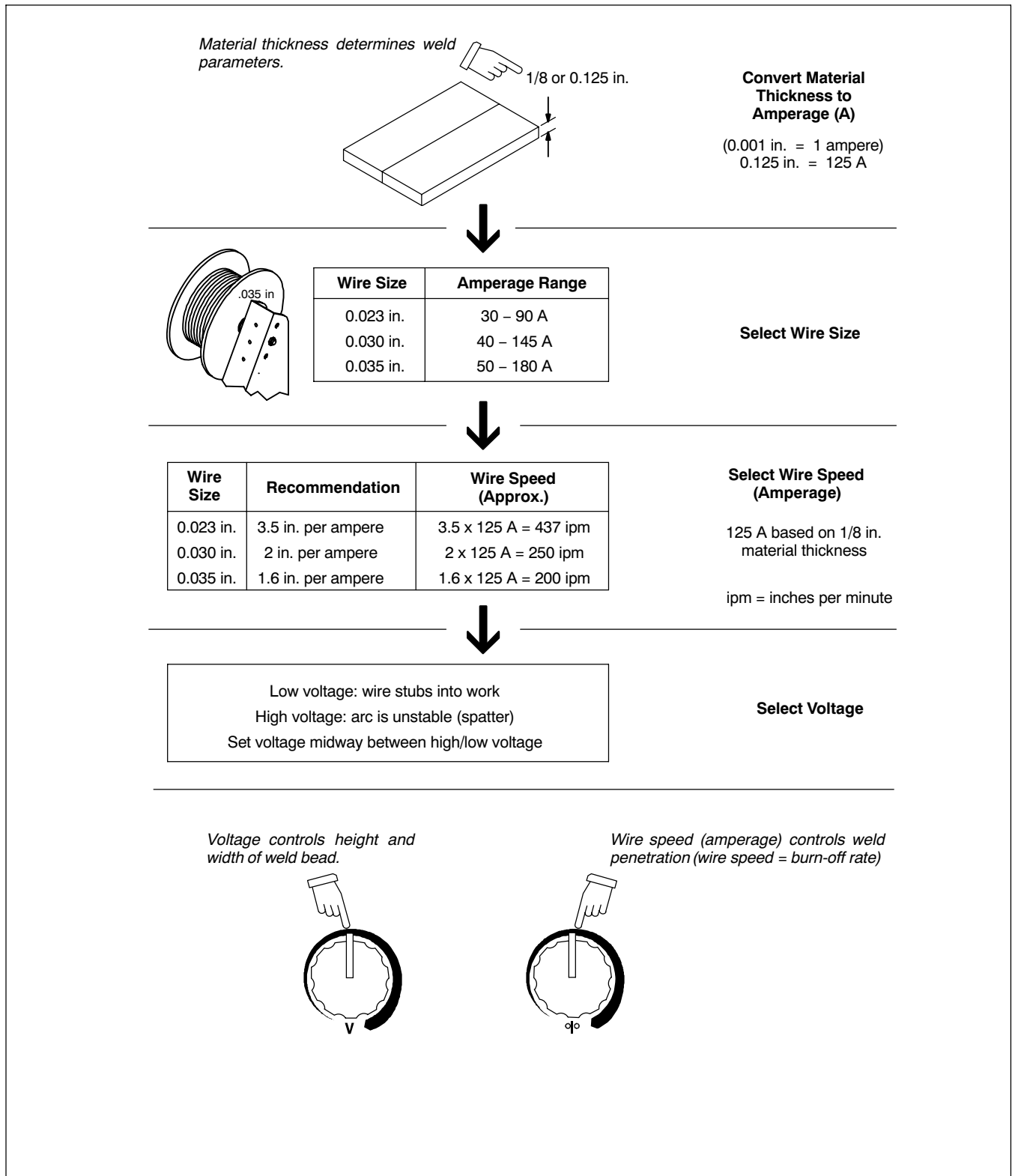

9-3. Holding And Positioning Welding Gun

☞ Welding wire is energized when gun trigger is pressed. Before lowering helmet and pressing trigger, be sure wire is no more than 1/2 in. (13 mm) past end of nozzle, and tip of wire is positioned correctly on seam.

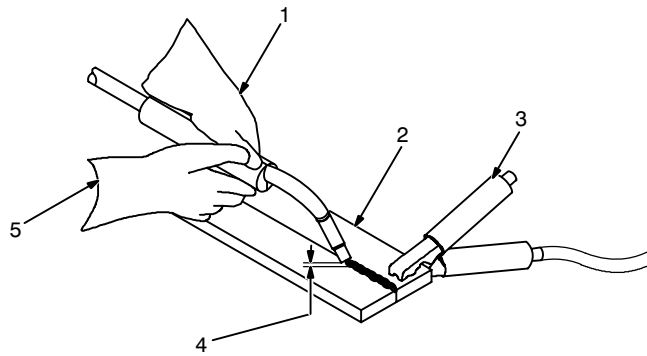

- 1 Hold Gun and Control Gun Trigger
- 2 Workpiece
- 3 Work Clamp
- 4 Electrode Extension (Stickout) 1/4 to 1/2 in. (6 To 13 mm)
- 5 Cradle Gun and Rest Hand on Workpiece

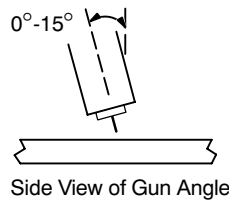
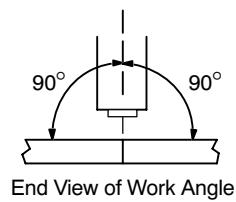

GROOVE WELDS

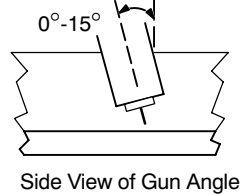
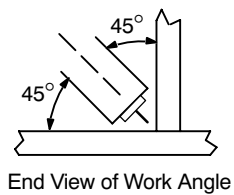

FILLET WELDS

S-0421-A

9-4. Conditions That Affect Weld Bead Shape

☞ Weld bead shape depends on gun angle, direction of travel, electrode extension (stickout), travel speed, thickness of base metal, wire feed speed (weld current), and voltage.

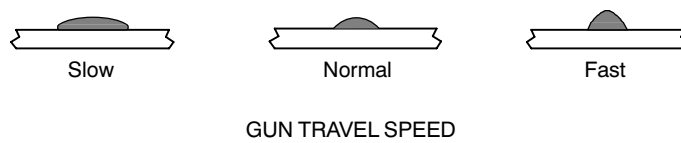
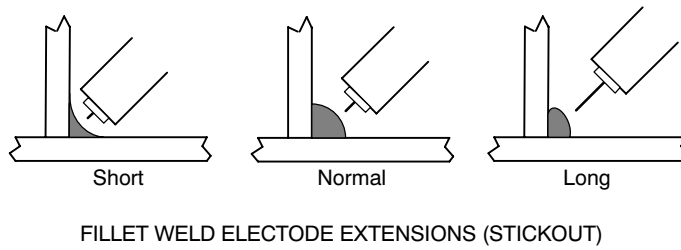
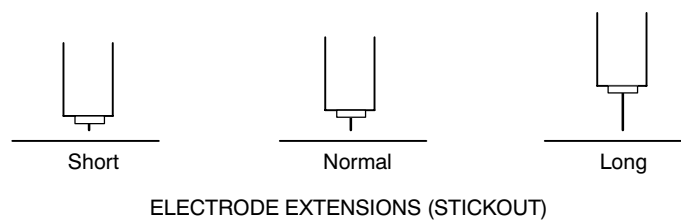
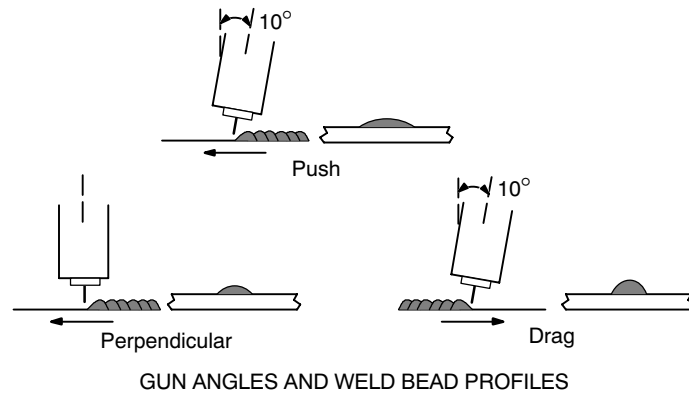

S-0634

9-5. Gun Movement During Welding

☞ Normally, a single stringer bead is satisfactory for most narrow groove weld joints; however, for wide groove weld joints or bridging across gaps, a weave bead or multiple stringer beads works better.

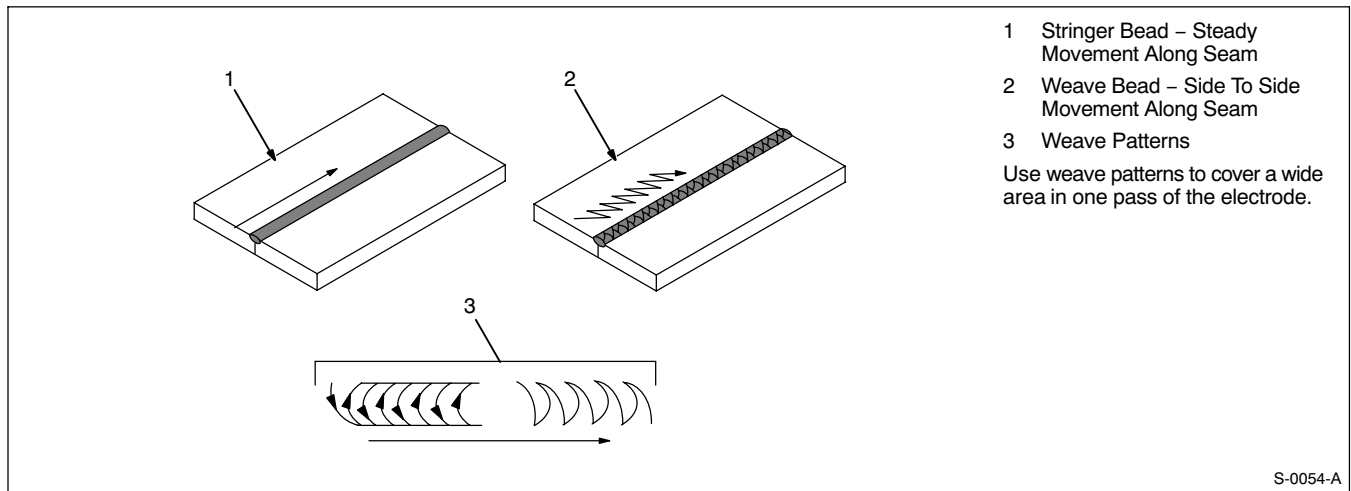

9-6. Poor Weld Bead Characteristics

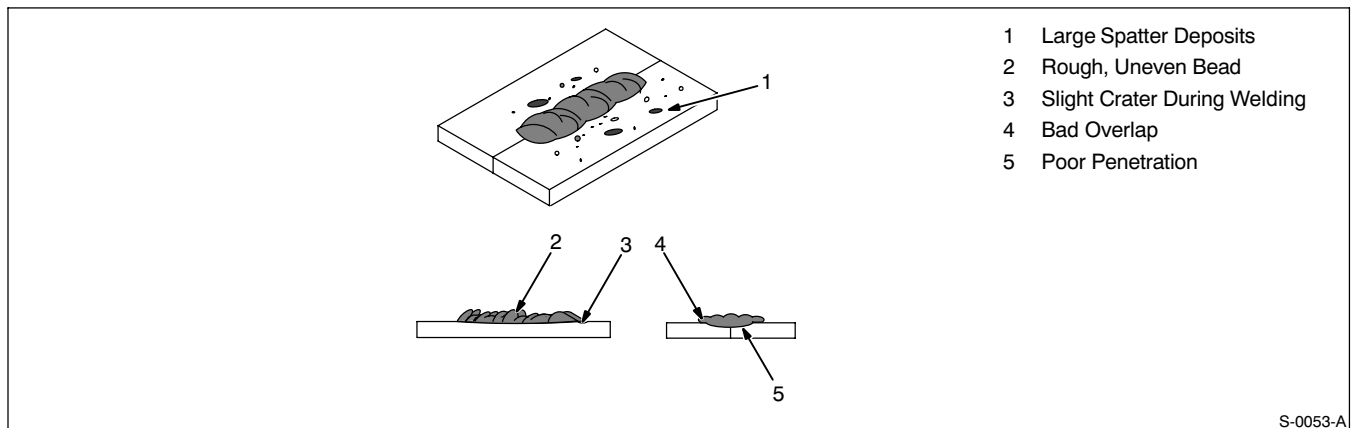

9-7. Good Weld Bead Characteristics

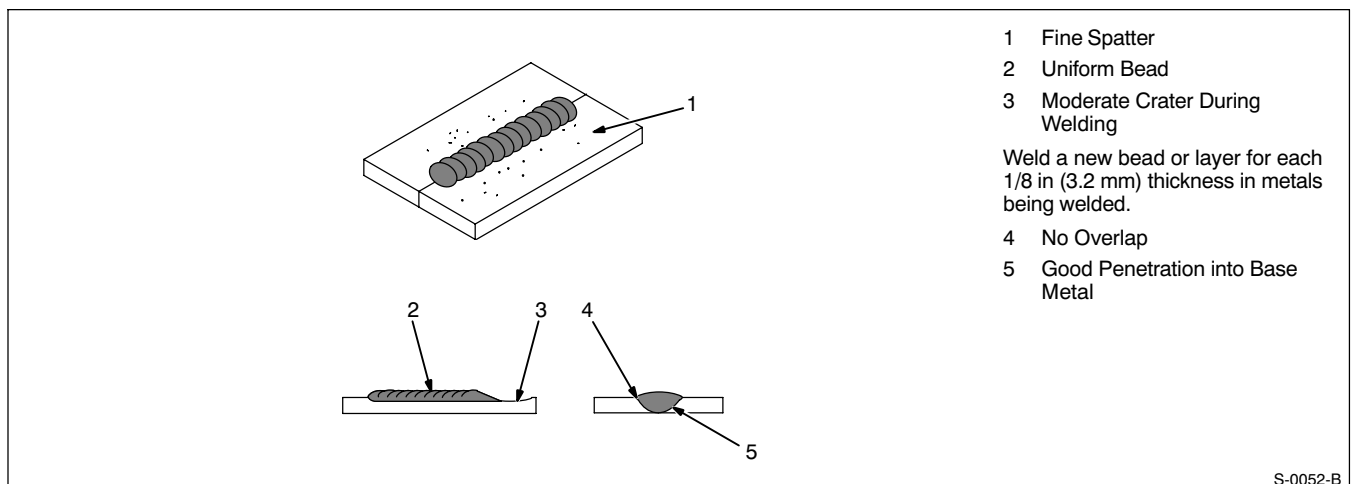

9-8. Troubleshooting – Excessive Spatter

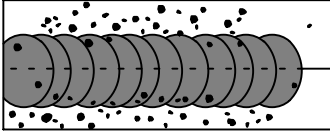

Excessive Spatter – scattering of molten metal particles that cool to solid form near weld bead.

S-0636

Possible Causes	Corrective Actions
Wire feed speed too high.	Select lower wire feed speed.
Voltage too high.	Select lower voltage range.
Electrode extension (stickout) too long.	Use shorter electrode extension (stickout).
Workpiece dirty.	Remove all grease, oil, moisture, rust, paint, undercoating, and dirt from work surface before welding.
Insufficient shielding gas at welding arc.	Increase flow of shielding gas at regulator/flowmeter and/or prevent drafts near welding arc.
Dirty welding wire.	Use clean, dry welding wire.
	Eliminate pickup of oil or lubricant on welding wire from feeder or liner.
Incorrect polarity.	Check polarity required by welding wire, and change to correct polarity at welding power source.

9-9. Troubleshooting – Porosity

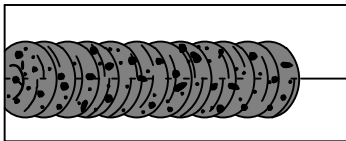

Porosity – small cavities or holes resulting from gas pockets in weld metal.

S-0635

Possible Causes	Corrective Actions
Insufficient shielding gas at welding arc.	Increase flow of shielding gas at regulator/flowmeter and/or prevent drafts near welding arc.
	Remove spatter from gun nozzle.
	Check gas hoses for leaks.
	Place nozzle 1/4 to 1/2 in. (6-13 mm) from workpiece.
	Hold gun near bead at end of weld until molten metal solidifies.
Wrong gas.	Use welding grade shielding gas; change to different gas.
Dirty welding wire.	Use clean, dry welding wire.
	Eliminate pick up of oil or lubricant on welding wire from feeder or liner.
Workpiece dirty.	Remove all grease, oil, moisture, rust, paint, coatings, and dirt from work surface before welding.
	Use a more highly deoxidizing welding wire (contact supplier).
Welding wire extends too far out of nozzle.	Be sure welding wire extends not more than 1/2 in. (13 mm) beyond nozzle.

9-10. Troubleshooting – Excessive Penetration

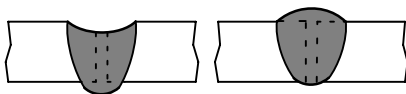

Excessive Penetration Good Penetration

Excessive Penetration – weld metal melting through base metal and hanging underneath weld.

S-0639

Possible Causes	Corrective Actions
Excessive heat input.	Select lower voltage range and reduce wire feed speed.
	Increase travel speed.

9-11. Troubleshooting – Lack Of Penetration

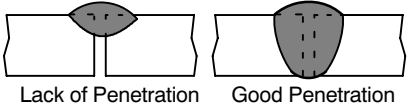
 <p>Lack Of Penetration – shallow fusion between weld metal and base metal.</p>		S-0638
Possible Causes	Corrective Actions	
Improper joint preparation.	Material too thick. Joint preparation and design must provide access to bottom of groove while maintaining proper welding wire extension and arc characteristics.	
Improper weld technique.	Maintain normal gun angle of 0 to 15 degrees to achieve maximum penetration.	
	Keep arc on leading edge of weld puddle.	
	Be sure welding wire extends not more than 1/2 in. (13 mm) beyond nozzle.	
Insufficient heat input.	Select higher wire feed speed and/or select higher voltage range.	
	Reduce travel speed.	
Incorrect polarity.	Check polarity required by welding wire, and change to correct polarity at welding power source.	

9-12. Troubleshooting – Incomplete Fusion

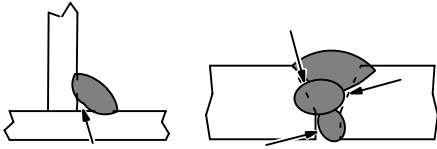
 <p>Incomplete Fusion – failure of weld metal to fuse completely with base metal or a preceding weld bead.</p>		S-0637
Possible Causes	Corrective Actions	
Workpiece dirty.	Remove all grease, oil, moisture, rust, paint, undercoating, and dirt from work surface before welding.	
Insufficient heat input.	Select higher voltage range and/or adjust wire feed speed.	
Improper welding technique.	Place stringer bead in proper location(s) at joint during welding.	
	Adjust work angle or widen groove to access bottom during welding.	
	Momentarily hold arc on groove side walls when using weaving technique.	
	Keep arc on leading edge of weld puddle.	
	Use correct gun angle of 0 to 15 degrees.	

9-13. Troubleshooting – Burn-Through

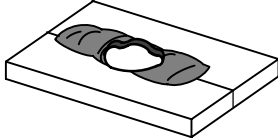
 <p>Burn-Through – weld metal melting completely through base metal resulting in holes where no metal remains.</p>		S-0640
Possible Causes	Corrective Actions	
Excessive heat input.	Select lower voltage range and reduce wire feed speed.	
	Increase and/or maintain steady travel speed.	

9-14. Troubleshooting – Waviness Of Bead

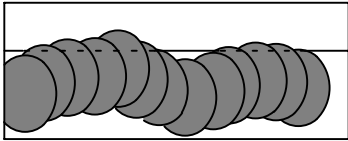

Waviness Of Bead – weld metal that is not parallel and does not cover joint formed by base metal.

S-0641

Possible Causes	Corrective Actions
Welding wire extends too far out of nozzle.	Be sure welding wire extends not more than 1/2 in (13 mm) beyond nozzle.
Unsteady hand.	Support hand on solid surface or use two hands.

9-15. Troubleshooting – Distortion

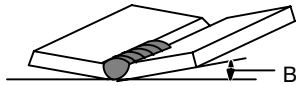

Base metal moves in the direction of the weld bead.

Distortion – contraction of weld metal during welding that forces base metal to move.

S-0642

Possible Causes	Corrective Actions
Excessive heat input.	Use restraint (clamp) to hold base metal in position.
	Make tack welds along joint before starting welding operation.
	Select lower voltage range and/or reduce wire feed speed.
	Increase travel speed.
	Weld in small segments and allow cooling between welds.

9-16. Common MIG Shielding Gases

This is a general chart for common gases and where they are used. Many different combinations (mixtures) of shielding gases have been developed over the years. The most commonly used shielding gases are listed in the following table.

Gas	Application			
	Spray Arc Steel	Short Circuiting Steel	Short Circuiting Stainless Steel	Aluminum
Argon				X
Argon + 25% CO ₂		X		
80% or greater Argon + balance CO ₂ or Oxygen	X	X ¹		
100% CO ₂		X		
Tri-Mix ²			X	

1 Limited short circuiting use

2 90% HE + 7-1/2% AR + 2-1/2% CO₂

9-17. Troubleshooting Guide For Semiautomatic Welding Equipment

Problem	Probable Cause	Remedy
Wire feed motor operates, but wire does not feed.	Too little pressure on wire feed rolls.	Increase pressure setting on wire feed rolls.
	Incorrect wire feed rolls.	Check size stamped on wire feed rolls, replace to match wire size and type if necessary.
	Wire spool brake pressure too high.	Decrease brake pressure on wire spool.
	Restriction in the gun and/or assembly.	Check and replace cable, gun, and contact tip if damaged. Check size of contact tip and cable liner, replace if necessary.
Wire curling up in front of the wire feed rolls (bird nesting).	Too much pressure on wire feed rolls.	Decrease pressure setting on wire feed rolls.
	Incorrect cable liner or gun contact tip size.	Check size of contact tip and check cable liner length and diameter, replace if necessary.
	Gun end not inserted into drive housing properly.	Loosen gun securing bolt in drive housing and push gun end into housing just enough so it does not touch wire feed rolls.
	Dirty or damaged (kinked) liner.	Replace liner.
Wire feeds, but no gas flows.	Gas cylinder empty.	Replace empty gas cylinder.
	Gas nozzle plugged.	Clean or replace gas nozzle.
	Gas cylinder valve not open or flowmeter not adjusted.	Open gas valve at cylinder and adjust flow rate.
	Restriction in gas line.	Check gas hose between flowmeter and wire feeder, and gas hose in gun and cable assembly.
	Loose or broken wires to gas solenoid.	Have Factory Authorized Service Agent repair wiring.
	Gas solenoid valve not operating.	Have Factory Authorized Service Agent replace gas solenoid valve.
	Incorrect primary voltage connected to welding power source.	Check primary voltage and relink welding power source for correct voltage.

Problem	Probable Cause	Remedy
Welding arc not stable.	Wire slipping in drive rolls.	Adjust pressure setting on wire feed rolls. Replace worn drive rolls if necessary.
	Wrong size gun liner or contact tip.	Match liner and contact tip to wire size and type.
	Incorrect voltage setting for selected wire feed speed on welding power source.	Readjust welding parameters.
	Loose connections at the gun weld cable or work cable.	Check and tighten all connections.
	Gun in poor shape or loose connection inside gun.	Repair or replace gun as necessary.

SECTION 10 – PARTS LIST

 Hardware is common and not available unless listed.

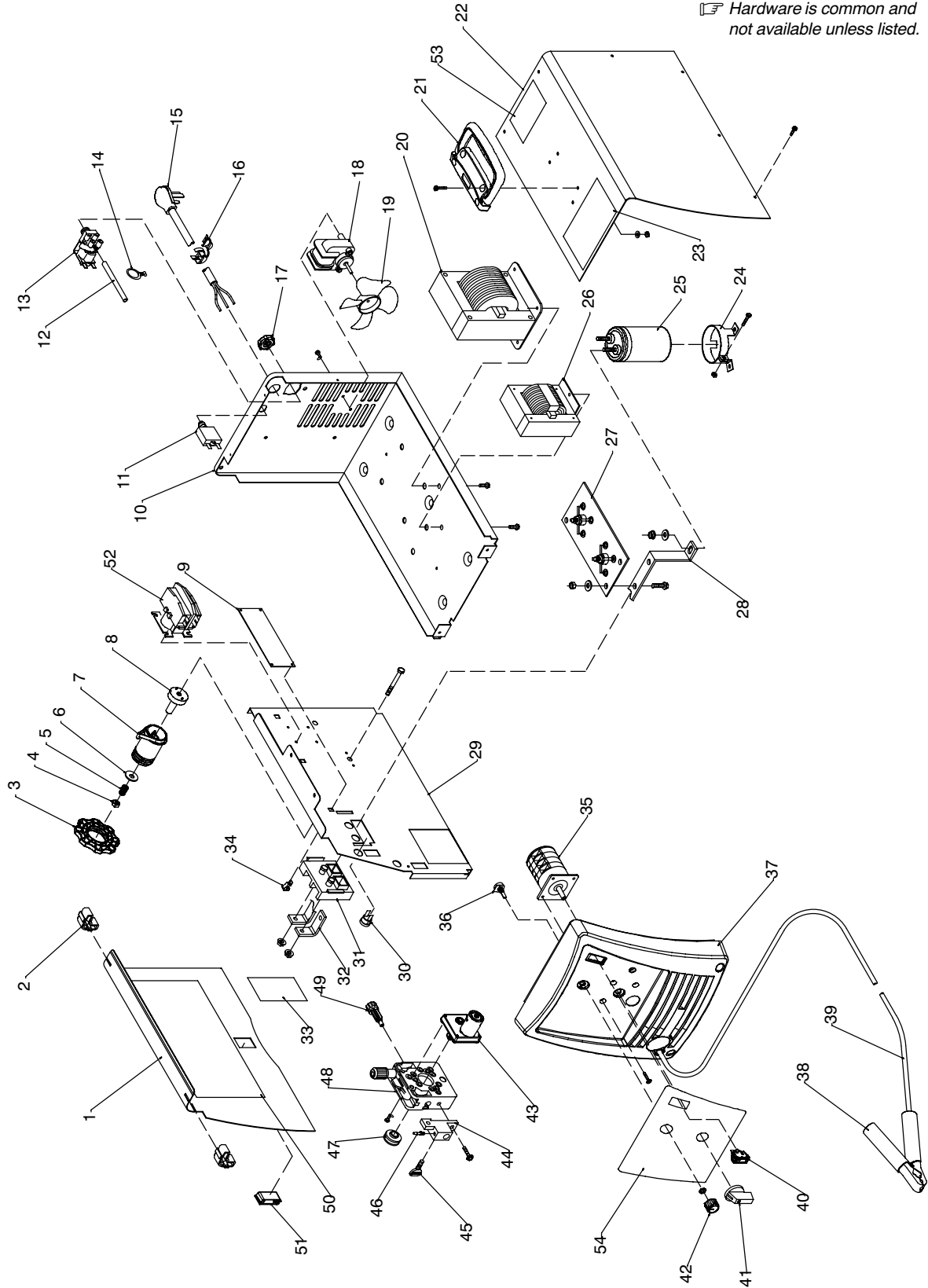

Figure 10-1. Main Assembly

804 624-A

Item No.	Dia. Mkgs.	Part No.	Description	Quantity
----------	------------	----------	-------------	----------

Figure 10-1. Main Assembly

... 1		199 566	.. DOOR, access	1
... 2		196 006	.. HINGE, door	2
... 3		211 887	.. HUB, nut	1
... 4		204 608	.. NUT	1
... 5		202 998	.. SPRING, cprsn	1
... 6		203 072	.. WASHER, flat	1
... 7		211 339	.. HUB, spool	1
... 8		202 726	.. ADAPTER, spool hub	1
... 9		217 078	.. CIRCUIT CARD ASSY, control	1
... 10		195 999	.. BASE, lower	1
... 11		210 109	.. SUPPLEMENTARY PROTECTOR, 25 amp	1
... 12		196 467	.. TUBING, PVC .187 ID x .312 OD x 23.00	1
... 13		216 398	.. VALVE, gas	1
... 14		197 198	.. CABLE TIE, .700-.799 bundle dia	2
... 15		152 118	.. CORD SET, 250V 6-50P 12GA 3/C 7ft SPT-3 jkt	1
... 16		111 443	.. BUSHING, strain relief	1
... 17		137 761	.. NUT, gas valve	1
... 18		196 064	.. MOTOR, fan	1
... 19	409	953-001	.. BLADE, fan cooling	1
... 20		226 069	.. TRANSFORMER, power assy	1
... 21		208 015	.. HANDLE, carrying	1
... 22		+196 005	.. WRAPPER	1
... 23		204 036	.. LABEL, warning	1
... 24		203 491	.. CLAMP, capacitor	1
... 25		193 040	.. CAPACITOR, electrft 100000uf	1
... 26		225 891	.. REACTOR ASSY	1
... 27		193 316	.. RECTIFIER ASSY	1
... 28		193 193	.. BUS BAR (positive)	1
... 29		217 831	.. BAFFLE, center	1
... 30	405	576-001	.. BUSHING, terminal	1
... 31		193 144	.. INSULATOR, output stud	1
... 32		193 194	.. BUS BAR (negative)	1
... 33		216 830	.. LABEL, warning	1
... 34		134 201	.. STAND-OFF	1
... 35		226 813	.. SWITCH, rotary 32A 7 position	1
... 36		209 873	.. POTENTIOMETER,	1
... 37		229 738	.. PANEL, front	1
... 38		208 820	.. CLAMP, work	1
... 39		196 619	.. CABLE, work	1

Item No.	Dia. Mkgs.	Part No.	Description	Quantity
Figure 10-1. Main Assembly (Continued)				
... 40	...	196 574	.. SWITCH, rocker DPST	1
... 41	...	228 400	.. KNOB, pointer (voltage)	1
... 42	...	211 338	.. KNOB, pointer (WFS)	1
... 43	...	217 778	.. MOTOR, gear	1
... 44	...	193 189	.. CONNECTOR, gun	1
... 45	...	196 654	.. SCREW, thumb	1
... 46	...	230 012	.. FITTING, gas barbed	1
... 47	...	237 338	.. ROLL, drive v groove .024,.030-.035 wire	1
... 48	...	194 508	.. HEAD, feed assy	1
... 49	...	203 025	.. GUIDE, wire inlet	1
... 50	...	227 010	.. LABEL, weld chart	1
... 51	...	204 711	.. LATCH	1
... 52	...	217 585	.. CONTACTOR	1
... 53	...	203 572	.. LABEL, warn gen precaution (EN/FR models only)	1
... 54 LABEL, nameplate (order by model and serial number)	1
...	...	221 037	.. REGULATOR/FLOWMETER, 10-50 CFH argon/mix	1
...	...	183 581	.. HOSE, assembly gas	1

+When ordering a component originally displaying a precautionary label, the label should also be ordered.

To maintain the factory original performance of your equipment, use only Manufacturer's Suggested Replacement Parts. Model and serial number required when ordering parts from your local distributor.

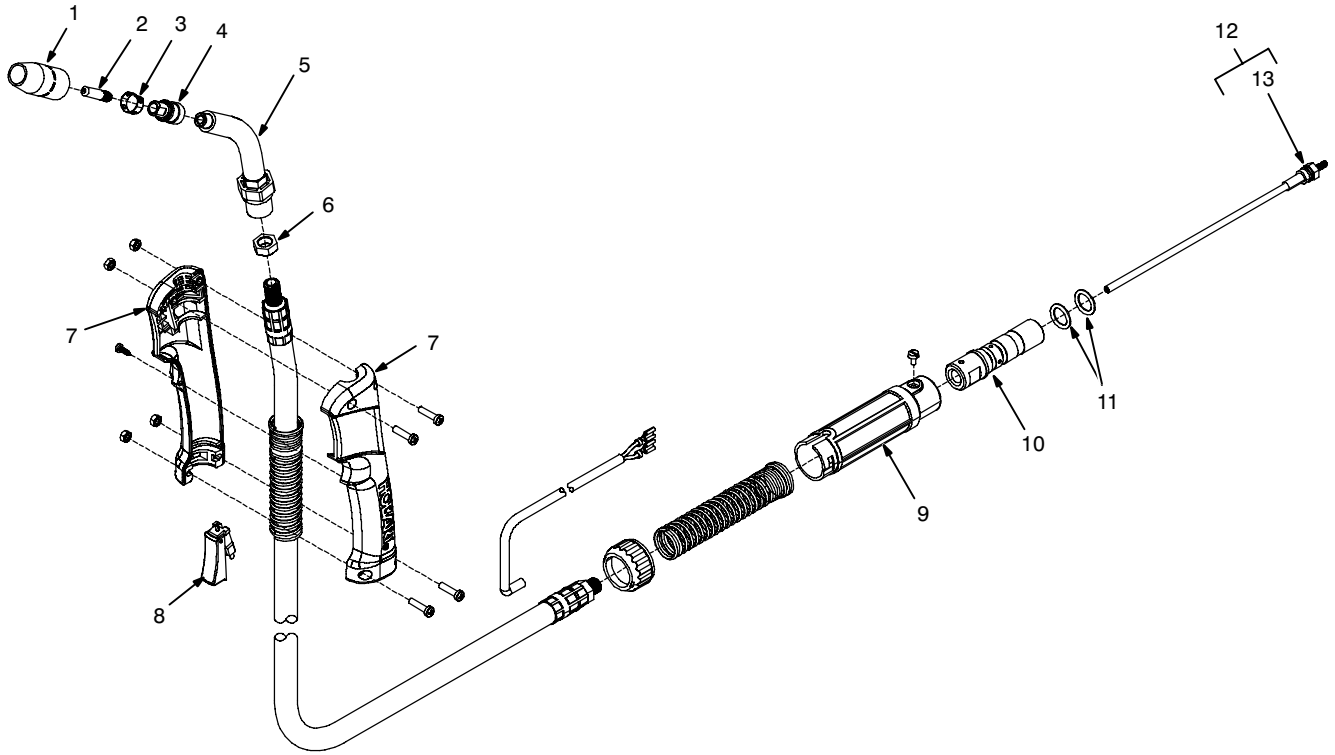

246 670-A

Figure 10-2. H100S2-10 Gun

Item No.	Dia. Mkgs.	Part No.	Description	Quantity
245 924 Figure 10-2. H100S2-10 Gun				
... 1	169 715	.. NOZZLE, slip type .500 orf flush	1
... 1	+226 190	.. NOZZLE, flux cored slip type	1
... 2	+087 299	.. TIP, contact scr .023 wire x 1.125	1
... 2	+000 067	.. TIP, contact scr .030 wire x 1.125	1
... 2	+000 068	.. TIP, contact scr .035 wire x 1.125	1
... 2	+000 069	.. TIP, contact scr .045 wire x 1.125	1
... 3	170 470	.. RING, retaining	1
... 4	169 716	.. ADAPTER, contact tip	1
... 5	246 373	.. TUBE, head	1
... 6	243 865	.. NUT, jam	1
... 7	242 832	.. HANDLE	1
... 8	225 410	.. SWITCH, trigger	1
... 9	246 380	.. HOUSING, power pin	1
... 10	245 927	.. CONNECTOR, feeder	1
... 11	197 123	.. O-RING, .312 ID X .062 70 duro buna-n	2
... 12	+194 010	.. LINER, monocoil .023/.025 wire x 15ft (consisting of)	1
... 12	+194 011	.. LINER, monocoil .030/.035 wire x 15ft (consisting of)	1
... 12	+194 012	.. LINER, monocoil .035/.045 wire x 15ft (consisting of)	1
... 13	079 975	... O-RING, .187 ID x .103CS rbr	1

+OPTIONAL

To maintain the factory original performance of your equipment, use only Manufacturer's Suggested Replacement Parts. Model is required when ordering parts from your local distributor.

10-3. Optional Drive Rolls

For All Feed Head Assemblies	
PART NO.	WIRE DIAMETER INCHES (mm)
237 338	.023/.025 (.6) and .030/.035 (.8 and .9)
202 926	.030/.035 (.8 and .9) and .045 (1.2 VK Groove)

10-4. Options

PART NO.	DESCRIPTION	REMARKS
770 187	Running Gear/Cylinder Rack	For One Small Gas Cylinder, 100 lb (45 kg) max.
194 776	Small Running Gear/Cylinder Rack	For One Small Gas Cylinder, 75 lb (34 kg) max.
246 800	H100S2-10 Replacement Gun	10 ft length/.030-.035 wire size
195 186	Protective Cover	Weatherproof nylon
212 492	Regulator/Flowmeter	For use with CO ₂ shielding gas, 10-50 CFH
144 108	Gas Hose 5 ft	For use with regulator/flowmeter 212 492

NOTE: If individual parts are required, see Parts List chapter of this manual for part number to order.

HOBART 5/3/1 WARRANTY

Effective January 1, 2009

Warranty Questions?

Call

1-800-332-3281

7 AM – 6 PM EST

Service

You always get the fast, reliable response you need. Most replacement parts can be in your hands in 24 hours.

Support

Need fast answers to the tough welding questions? Contact your distributor or call 1-800-332-3281. The expertise of the distributor and Hobart is there to help you, every step of the way.

Assistance

Visit the Hobart website:
www.HobartWelders.com

5/3/1 WARRANTY applies to all Hobart welding equipment, plasma cutters and spot welders with a serial number preface of LK or newer.

This limited warranty supersedes all previous Hobart warranties and is exclusive with no other guarantees or warranties expressed or implied.

Hobart products are serviced by Hobart or Miller Authorized Service Agencies.

LIMITED WARRANTY – Subject to the terms and conditions below, Hobart/Miller Electric Mfg. Co., Appleton, Wisconsin, warrants to its original retail purchaser that new Hobart equipment sold after the effective date of this limited warranty is free of defects in material and workmanship at the time it is shipped by Hobart. THIS WARRANTY IS EXPRESSLY IN LIEU OF ALL OTHER WARRANTIES, EXPRESS OR IMPLIED, INCLUDING THE WARRANTIES OF MERCHANTABILITY AND FITNESS.

Within the warranty periods listed below, Hobart/Miller will repair or replace any warranted parts or components that fail due to such defects in material or workmanship. Hobart/Miller must be notified in writing within thirty (30) days of such defect or failure, at which time Hobart/Miller will provide instructions on the warranty claim procedures to be followed.

Hobart/Miller shall honor warranty claims on warranted equipment listed below in the event of such a failure within the warranty time periods. All warranty time periods start on the delivery date of the equipment to the original retail purchaser, and not to exceed one year after the equipment is shipped to a North American distributor or eighteen months after the equipment is shipped to an International distributor.

1. 5 Years — Parts and Labor
 - * Original Main Power Rectifiers only to include SCRs, diodes, and discrete rectifier modules
 - * Transformers
 - * Stabilizers
 - * Reactors
2. 3 Years — Parts and Labor
 - * Drive Systems
 - * PC Boards
 - * Rotors, Stators and Brushes
 - * Idle Module
 - * Solenoid Valves
 - * Switches and Controls
 - * Spot Welder Transformer
3. 1 Year — Parts and Labor Unless Specified (90 days for industrial use)
 - * Motor-Driven Guns
 - * MIG Guns/TIG Torches
 - * Relays
 - * Contactors
 - * Regulators
 - * Water Coolant Systems
 - * Flowgauge and Flowmeter Regulators (No Labor)
 - * HF Units
 - * Running Gear/Trailers
 - * Plasma Cutting Torches
 - * Remote Controls
 - * Replacement Parts (No labor) – 90 days
 - * Accessories
 - * Field Options
(NOTE: Field options are covered for the remaining warranty period of the product they are installed in, or for a minimum of one year — whichever is greater.)
4. Engines, batteries and tires are warranted separately by the manufacturer.

Hobart's 5/3/1 Limited Warranty shall not apply to:

1. **Consumable components such as contact tips, cutting nozzles, slip rings, drive rolls, gas diffusers, plasma torch tips and electrodes, weld cables, and tongs and tips, or parts that fail due to normal wear.** (Exception: brushes, slip rings, and relays are covered on Hobart Engine-Driven models.)
2. Items furnished by Hobart/Miller, but manufactured by others, such as engines or trade accessories. These items are covered by the manufacturer's warranty, if any.
3. Equipment that has been modified by any party other than Hobart/Miller, or equipment that has been improperly installed, improperly operated or misused based upon industry standards, or equipment which has not had reasonable and necessary maintenance, or equipment which has been used for operation outside of the specifications for the equipment.

HOBART PRODUCTS ARE INTENDED FOR PURCHASE AND USE BY COMMERCIAL/INDUSTRIAL USERS AND PERSONS TRAINED AND EXPERIENCED IN THE USE AND MAINTENANCE OF WELDING EQUIPMENT.

In the event of a warranty claim covered by this warranty, the exclusive remedies shall be, at Hobart's/Miller's option: (1) repair; or (2) replacement; or, where authorized in writing by Hobart/Miller in appropriate cases, (3) the reasonable cost of repair or replacement at an authorized Hobart/Miller service station; or (4) payment of or credit for the purchase price (less reasonable depreciation based upon actual use) upon return of the goods at customer's risk and expense. Hobart's/Miller's option of repair or replacement will be F.O.B., Factory at Appleton, Wisconsin, or F.O.B. at a Hobart/Miller authorized service facility as determined by Hobart/Miller. Therefore no compensation or reimbursement for transportation costs of any kind will be allowed.

TO THE EXTENT PERMITTED BY LAW, THE REMEDIES PROVIDED HEREIN ARE THE SOLE AND EXCLUSIVE REMEDIES. IN NO EVENT SHALL HOBART/MILLER BE LIABLE FOR DIRECT, INDIRECT, SPECIAL, INCIDENTAL OR CONSEQUENTIAL DAMAGES (INCLUDING LOSS OF PROFIT), WHETHER BASED ON CONTRACT, TORT OR ANY OTHER LEGAL THEORY.

ANY EXPRESS WARRANTY NOT PROVIDED HEREIN AND ANY IMPLIED WARRANTY, GUARANTY OR REPRESENTATION AS TO PERFORMANCE, AND ANY REMEDY FOR BREACH OF CONTRACT TORT OR ANY OTHER LEGAL THEORY WHICH, BUT FOR THIS PROVISION, MIGHT ARISE BY IMPLICATION, OPERATION OF LAW, CUSTOM OF TRADE OR COURSE OF DEALING, INCLUDING ANY IMPLIED WARRANTY OF MERCHANTABILITY OR FITNESS FOR PARTICULAR PURPOSE, WITH RESPECT TO ANY AND ALL EQUIPMENT FURNISHED BY HOBART/MILLER IS EXCLUDED AND DISCLAIMED BY Hobart/Miller.

Some states in the U.S.A. do not allow limitations of how long an implied warranty lasts, or the exclusion of incidental, indirect, special or consequential damages, so the above limitation or exclusion may not apply to you. This warranty provides specific legal rights, and other rights may be available, but may vary from state to state.

In Canada, legislation in some provinces provides for certain additional warranties or remedies other than as stated herein, and to the extent that they may not be waived, the limitations and exclusions set out above may not apply. This Limited Warranty provides specific legal rights, and other rights may be available, but may vary from province to province.

hobart_warr 2009-01





Owner's Record

Please complete and retain with your personal records.

Model Name _____ Serial/Style Number _____

Purchase Date _____ (Date which equipment was delivered to original customer.)

Distributor _____

Address _____

City _____

State _____ Zip _____



Resources Available

Always provide Model Name and Serial/Style Number.

To locate a Distributor, retail or service location:

Call 1-877-Hobart1 or visit our website at www.HobartWelders.com

For technical assistance:

Call 1-800-332-3281

Contact your Distributor for:

- Welding Supplies and Consumables
- Options and Accessories
- Personal Safety Equipment
- Service and Repair
- Replacement Parts
- Training (Schools, Videos, Books)
- Technical Manuals (Servicing Information and Parts)
- Circuit Diagrams
- Welding Process Handbooks

Contact the Delivering Carrier to:

File a claim for loss or damage during shipment.

For assistance in filing or settling claims, contact your distributor and/or equipment manufacturer's Transportation Department.

Protect Your Investment!



Register your product at:
HobartWelders.com

Hobart Welding Products

An Illinois Tool Works Company
600 West Main Street
Troy, OH 45373 USA

For Technical Assistance:

Call 1-800-332-3281
For Literature Or Nearest Dealer:
Call 1-877-Hobart1

