

JET[®]

Operating Instructions and Parts Manual Benchtop Oscillating Spindle Sander Model JBOS-5



For models with serial no. 11095097 and higher

WALTER MEIER (Manufacturing) Inc.

427 New Sanford Road
LaVergne, Tennessee 37086
Ph.: 800-274-6848
www.waltermeier.com

Part No. M-708404

Revision C1 06/2013

Copyright © 2013 Walter Meier (Manufacturing) Inc.

Warranty and Service

Walter Meier (Manufacturing) Inc., warrants every product it sells. If one of our tools needs service or repair, one of our Authorized Service Centers located throughout the United States can give you quick service. In most cases, any of these Walter Meier Authorized Service Centers can authorize warranty repair, assist you in obtaining parts, or perform routine maintenance and major repair on your JET® tools. For the name of an Authorized Service Center in your area call 1-800-274-6848.

MORE INFORMATION

Walter Meier is consistently adding new products to the line. For complete, up-to-date product information, check with your local Walter Meier distributor, or visit waltermeier.com.

WARRANTY

JET products carry a limited warranty which varies in duration based upon the product (MW = Metalworking, WW = Woodworking).

90 DAY WARRANTY	1 YEAR WARRANTY	Body Repair Kits Bottle Jacks Cable Pullers Cold Saws Hoists-Air Hoists-Electric Metal forming Mill/Drills Milling Machines MW Bandsaws MW Drill Presses MW Finishing Equipment MW Lathes MW Precision Vises	2 YEAR WARRANTY	Palet Trucks Rigging Equip. Service Jacks Stackers Surface Grinders Tapping Trolleys-Air Trolleys-Electric Web Slings Winches-Electric	3 YEAR WARRANTY	WW Benchtop Tools	5 YEAR WARRANTY	Beam Clamps Chain Hoist- Manual Lever Hoists Pullers-JCH Models Scissor Lift Tables Screw Jacks Trolleys-Geared Trolleys-Plain Winches-Manual WW Air Filtration WW Bandsaws WW Buffers	WW Drill Presses WW Dust Collectors WW Dust Filters WW Dust Fittings WW Jointers WW Lathes WW Planers WW Sanders WW Shapers WW Tablesaws	LIFE LIFETIME WARRANTY	Fastening Tools Mechanics Hand Tools Striking Tools Vises (no -precision) Clamps
Warranty reverts to 1 Year Warranty if woodworking (WW) products listed above are used for industrial or educational purposes.											

WHAT IS COVERED?

This warranty covers any defects in workmanship or materials subject to the exceptions stated below. Cutting tools, abrasives and other consumables are excluded from warranty coverage.

WHO IS COVERED?

This warranty covers only the initial purchaser of the product.

WHAT IS THE PERIOD OF COVERAGE?

The general JET warranty lasts for the time period specified in the product literature of each product.

WHAT IS NOT COVERED?

Five Year Warranties do not cover woodworking (WW) products used for commercial, industrial or educational purposes. Woodworking products with Five Year Warranties that are used for commercial, industrial or education purposes revert to a One Year Warranty. This warranty does not cover defects due directly or indirectly to misuse, abuse, negligence or accidents, normal wear-and-tear, improper repair or alterations, or lack of maintenance.

HOW TO GET SERVICE

The product or part must be returned for examination, postage prepaid, to a location designated by us. For the name of the location nearest you, please call 1-800-274-6848.

You must provide proof of initial purchase date and an explanation of the complaint must accompany the merchandise. If our inspection discloses a defect, we will repair or replace the product, or refund the purchase price, at our option. We will return the repaired product or replacement at our expense unless it is determined by us that there is no defect, or that the defect resulted from causes not within the scope of our warranty in which case we will, at your direction, dispose of or return the product. In the event you choose to have the product returned, you will be responsible for the shipping and handling costs of the return.

HOW STATE LAW APPLIES

This warranty gives you specific legal rights; you may also have other rights which vary from state to state.

LIMITATIONS ON THIS WARRANTY

WALTER MEIER (MANUFACTURING) INC., LIMITS ALL IMPLIED WARRANTIES TO THE PERIOD OF THE LIMITED WARRANTY FOR EACH PRODUCT. EXCEPT AS STATED HEREIN, ANY IMPLIED WARRANTIES OR MERCHANTABILITY AND FITNESS ARE EXCLUDED. SOME STATES DO NOT ALLOW LIMITATIONS ON HOW LONG THE IMPLIED WARRANTY LASTS, SO THE ABOVE LIMITATION MAY NOT APPLY TO YOU.

WALTER MEIER SHALL IN NO EVENT BE LIABLE FOR DEATH, INJURIES TO PERSONS OR PROPERTY, OR FOR INCIDENTAL, CONTINGENT, SPECIAL, OR CONSEQUENTIAL DAMAGES ARISING FROM THE USE OF OUR PRODUCTS. SOME STATES DO NOT ALLOW THE EXCLUSION OR LIMITATION OF INCIDENTAL OR CONSEQUENTIAL DAMAGES, SO THE ABOVE LIMITATION OR EXCLUSION MAY NOT APPLY TO YOU.

Walter Meier sells through distributors only. The specifications in Walter Meier catalogs are given as general information and are not binding. Members of Walter Meier reserve the right to effect at any time, without prior notice, those alterations to parts, fittings, and accessory equipment which they may deem necessary for any reason whatsoever. JET®-branded products are not sold in Canada by Walter Meier.

Table of Contents

- Warranty and Service 2
- Table of Contents 3
- Warning 4
- Introduction 5
- Specifications 5
- Unpacking and Setup 6
 - Contents of the Shipping Container 6
 - Spindle and Insert Storage Plates 6
 - Installing Spindles 6
 - Insert Plates 7
 - Setup for 90° 7
 - Setup for Bevel Sanding 7
 - Dust Collection 7
 - Turning the Sander On & Off 8
 - Removing Spindles 8
 - Changing Sanding Sleeves 8
- Insert Plate Diameters 9
- Optional Accessories (purchased separately) 10
- Replacement Parts 10
 - Table Assembly for the JBOS-5 11
 - Base and Motor Assembly for the JBOS-5 12
 - Parts List for the JBOS-5 13



Warnings

1. Read and understand the entire contents of this manual before attempting assembly or operation. Do not use this tool until proper training and knowledge have been obtained.
2. Keep guards in place and in working order.
3. Keep fingers and hands away from the spindle while in operation. Avoid getting fingers too close to the drum.
4. Remove adjusting keys and wrenches. Form habit of checking to see that keys and adjusting wrenches are removed before operating.
5. Keep work area clean. Cluttered areas and benches invite accidents.
6. Don't use in dangerous environment. Don't use power tools in damp or wet locations, or expose them to rain.
7. Keep children and visitors away. All children and visitors should be kept a safe distance from work area.
8. Don't force tool. It will do the job better and be safer at the rate for which it was designed.
9. Use right tool. Don't force a tool or attachment to do a job for which it was not designed.
10. Wear proper apparel. No loose clothing, gloves, neckties, rings, bracelets, or other jewelry to get caught in moving parts. Non-slip footwear is recommended. Wear protective hair covering to contain long hair.
11. Wear safety glasses (must comply with ANSI Z87.1). Everyday eyeglasses only have impact resistant lenses; they are not safety glasses. Also use face or dust mask if cutting operation is dusty.
12. Don't overreach. Keep proper footing and balance at all times.
13. Turn the machine off and unplug from the power source before changing spindles.
14. Be sure the spindle drum is in good condition with no tears or holes before operating the sander.
15. Disconnect tools before servicing and when changing accessories such as blades, bits, cutters, etc.
16. Avoid accidental starting. Make sure switch is in "OFF" position before plugging in power cord.
17. Never stand on tool. Serious injury could occur if the tool is tipped or if the cutting tool is accidentally contacted.
18. Check damaged parts. Before further use of the tool, a guard or other part that is damaged should be carefully checked to ensure that it will operate properly and perform its intended function – check for alignment of moving parts, binding of moving parts, breakage of parts, mounting, and any other conditions that may affect its operation. A guard or other part that is damaged should be properly repaired or replaced.
19. Do not operate tool while under the influence of drugs, alcohol or any medication.
20. Shut off power before servicing or adjusting.
21. Never leave the tool running while unattended. Turn power off. Don't leave until the tool comes to a complete stop.
22. Some dust created by power sanding, sawing, grinding, drilling and other construction activities contains chemicals known to cause cancer, birth defects or other reproductive harm. Some examples of these chemicals are:
 - Lead from lead based paint.
 - Crystalline silica from bricks, cement and other masonry products.
 - Arsenic and chromium from chemically treated lumber.Your risk of exposure varies, depending on how often you do this type of work. To reduce your exposure to these chemicals, work in a well-ventilated area and work with approved safety equipment, such as face or dust masks that are specifically designed to filter out microscopic particles.
23. Do not operate this machine while tired or under the influence of drugs, alcohol or any medication.

Introduction

This manual is provided by Walter Meier (Manufacturing) Inc., covering the safe operation and maintenance procedures for a JET Model JBOS-5 Oscillating Spindle Sander. This manual contains instructions on installation, safety precautions, general operating procedures, maintenance instructions and parts breakdown. This machine has been designed and constructed to provide years of trouble free operation if used in accordance with instructions set forth in this manual. If there are any questions or comments, please contact either your local supplier or Walter Meier. Walter Meier can also be reached at our web site: www.waltermeier.com.

Specifications

Model Number.....	JBOS-5
Stock Number	708404
Table Size (in.)	14-1/2 x 14-1/2
Table Tilt (deg.)	0 to 45 down
Height, without spindle (in.)	18-3/4
Base Footprint (in.).....	11-3/4 x 11-3/4
Spindle Speed (RPM)	1,725
Oscillations per Minute	30
Maximum Length of Oscillation (in.)	1
Oscillation Gear Environment	sealed oil bath
Dust Port outside diameter (in.)	2
Power Cord length (ft.)	5-1/2
Motor (TEFC)	TEFC Induction, 1/2 HP, 1PH, 110V, 60Hz, 7.5A
Switch.....	manual, with removable safety key
Net Weight (lb)	77
Shipping Weight (lb)	82

The above specifications were current at the time this manual was published, but because of our policy of continuous improvement, Walter Meier reserves the right to change specifications at any time and without prior notice, without incurring obligations.

Unpacking and Setup

Contents of the Shipping Container

(see Figure 1)

- 1 Spindle Sander
- 1 Spindle Storage Plate (pre-installed)
- 1 Insert Storage Plate (pre-installed)
- 2 Round Opening Inserts (3/4" and 2")
- 2 Oblong Opening Inserts (3/4" and 2")
- 5 Sanding Spindles & Sleeves:
1/4"x6"; 1/2"x6"; 5/8"x6";
1-1/2"x5-1/2"; 2"x5-1/2"
- 1 Open End Wrench (10-12mm)
- 2 Open End Wrenches (14-17mm)
- 1 Operator's Manual
- 1 Warranty Card

Finish removing all contents from the shipping container, and compare items with the list above. Contact your distributor or Walter Meier (Manufacturing) Inc., if any parts are missing. Do not discard any shipping material until the sander is set up and running properly.

Report damage, if any, to your local distributor and/or shipping company.

Exposed metal surfaces, including spindles, have been coated with a protectant. Clean these surfaces with a mild solvent or kerosene. Clean the spindles. Do **not** use lacquer thinner, paint thinner, or gasoline, as these will damage painted surfaces.

Periodically apply paste wax or other protectant to the table top to prevent rusting.

Spindle and Insert Storage Plates

See Figure 2.

Clean the insert plates and push the unused inserts into Storage Plate B. Place spindles in the opposite Storage Plate A.

Installing Spindles

1. Before inserting the threaded spindle into the spindle housing, make sure the surfaces are clean.
2. Thread the spindle counterclockwise into the spindle housing.
3. Using the provided wrenches, tighten the spindle nut (A, Figure 3) counterclockwise while holding the spindle housing flat (B, Figure 3) with the other wrench.
4. Do not over-tighten the spindle as it may be difficult to remove after the sanding operation.



Figure 1
Contents of Shipping Container

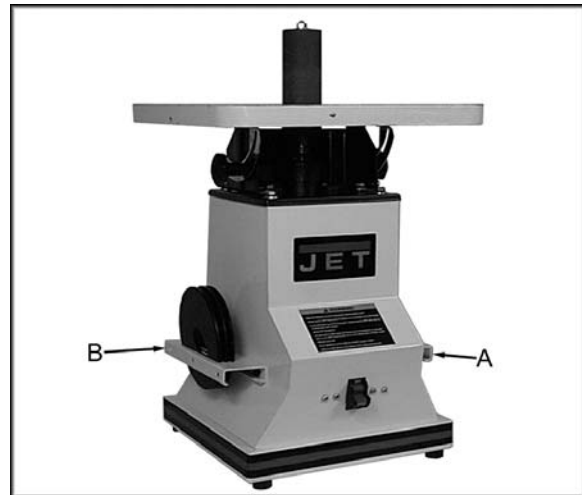

Figure 2

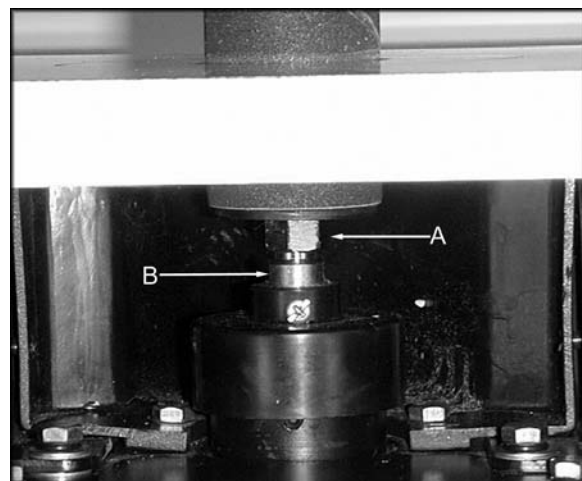

Figure 3

Insert Plates

1. Always use an insert plate.
2. There are 2 oblong, and 2 round insert plates included with the machine. The oblong insert plates are used when the table is tilted for bevel sanding. Each plate has a notch on the outer edge to ensure that it is inserted properly. (See page 9 to determine which insert plate to use with a particular spindle.)

Setup for 90°

1. Loosen both knobs, (A, Figure 4) and place the table in the 0° position.
2. Place a square (B, Figure 4) on the table. Rest the long section of the square against the sanding drum. The square should be flat against the table and the sanding drum.
3. If the table needs adjustment loosen both knobs and tilt the table so that the square is flat against the table and sanding drum.
4. Make sure the pointer (C, Figure 4) reads 0°. If the pointer needs adjusting loosen the screw (D, Figure 4), and adjust to the correct position.
5. Loosen lock nut (F, Figure 4), adjust the 90° stop bolt (E, Figure 4) with a 13mm open wrench so that it rests against the bottom side of the table, and re-tighten the lock nut (F, Figure 4) with a 12mm open wrench.

Setup for Bevel Sanding

1. Loosen both knobs (A, Figure 5) and adjust the table to the desired angle.
2. Tighten both knobs.

Dust Collection

The dust port (B, Figure 5) can be hooked directly to a 2" hose for dust collection.

See your local JET distributor for the complete line of dust collectors, as well as Hoses and Accessories. Customize your installation and obtain maximum performance with JET dust hoods, hoses, clamps, fittings, and blast gates.

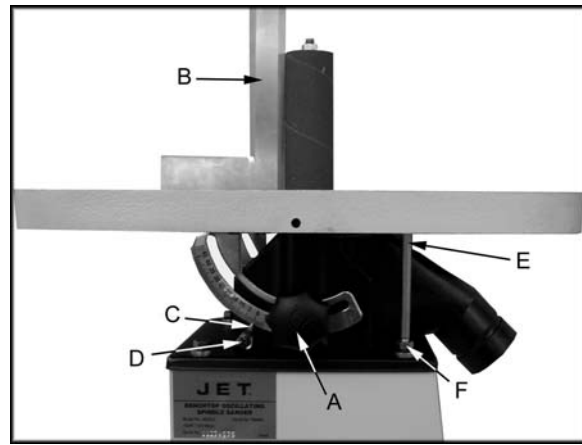

Figure 4

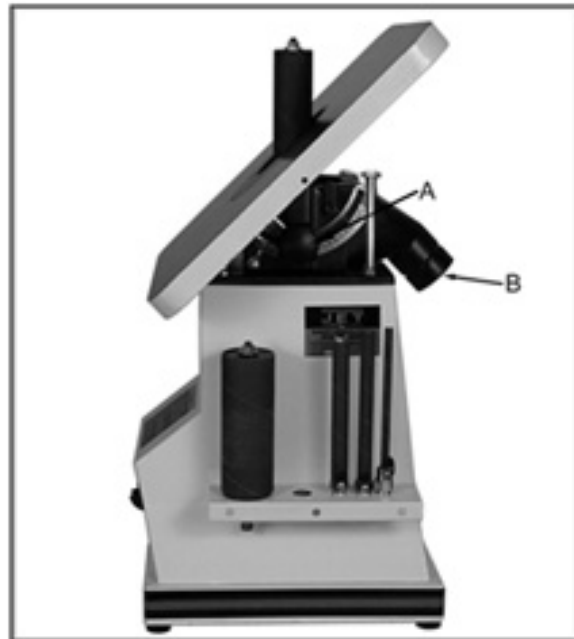

Figure 5

Turning the Sander On & Off

Note: Before hooking the sander to the power source, make sure the switch is in off position.

The sander can be turned on by flipping the switch to the on position.

There is a removable key in the tip of the switch that can be removed in the off position. When the key has been removed the dust collector cannot be used.

Removing Spindles

Using the provided wrenches, loosen the spindle nut (A, Figure 6) clockwise while holding the spindle housing flat (B, Figure 6) with the other wrench.

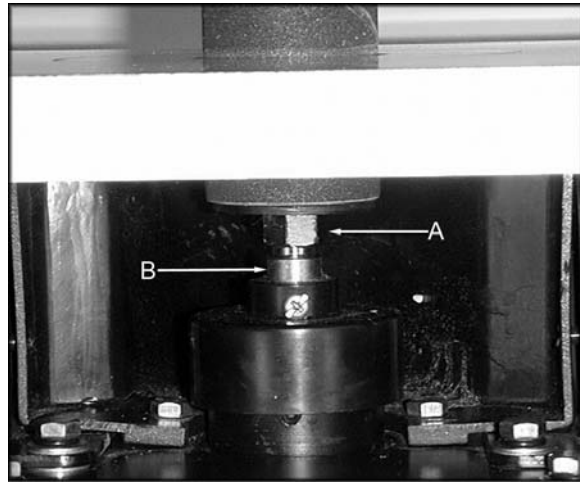

Figure 6

Changing Sanding Sleeves

1/4", 1/2" and 5/8"

1. Loosen the clamp (A, Figure 7) with a cross point screwdriver.
2. Remove the sanding sleeve from the spindle shaft.
3. Install the new sleeve, making sure to re-tighten the clamp.

1-1/2" and 2" (optional 3")

1. Loosen the nut (B, Figure 7) with the provided wrench.
2. Remove the sanding sleeve from the spindle shaft.
3. Reverse these steps to install the new sanding sleeve.

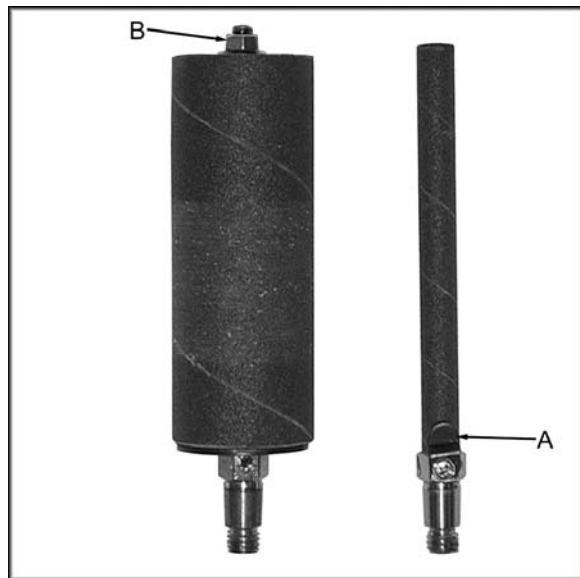
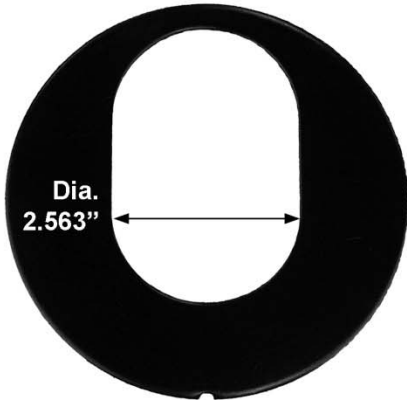

Figure 7

Insert Plate Diameters

This will assist you in determining which spindle diameters will work in each insert plate.



6286979 (fits 1-1/2" and 2" spindles)



6286980 (fits 1-1/2" and 2" spindles)



6286981 (fits 1/4" to 1" spindles)



6286982 (fits 1/4" to 1" spindles)



Accessory
item
(separate purchase)

6286984 (fits 3" spindles)

Optional Accessories (purchased separately)

709534 3" Dia. Spindle Assembly

6286984 Table Insert for 3" Spindle

Sanding Sleeves (4 per pack):

<i>Stock No.</i>	<i>Diameter (in.)</i>	<i>Length (in.)</i>	<i>Grit</i>
575891	1/4	6	60
575893	1/4	6	100
575894	1/4	6	150
575901	1/2	6	60
575903	1/2	6	100
575904	1/2	6	150
575906	5/8	6	60
575908	5/8	6	100
575909	5/8	6	150
575921	1-1/2	5-1/2	60
575923	1-1/2	5-1/2	100
575924	1-1/2	5-1/2	150
575931	2	5-1/2	60
575933	2	5-1/2	100
575934	2	5-1/2	150
575941	3	5-1/2	60
575943	3	5-1/2	100
575944	3	5-1/2	150

Replacement Parts

Replacement parts are listed on the following pages. To order parts or reach our service department, call 1-800-274-6848, Monday through Friday (see our website for business hours, www.waltermeier.com). Having the Model Number and Serial Number of your machine available when you call will allow us to serve you quickly and accurately.

Table Assembly for the JBOS-5

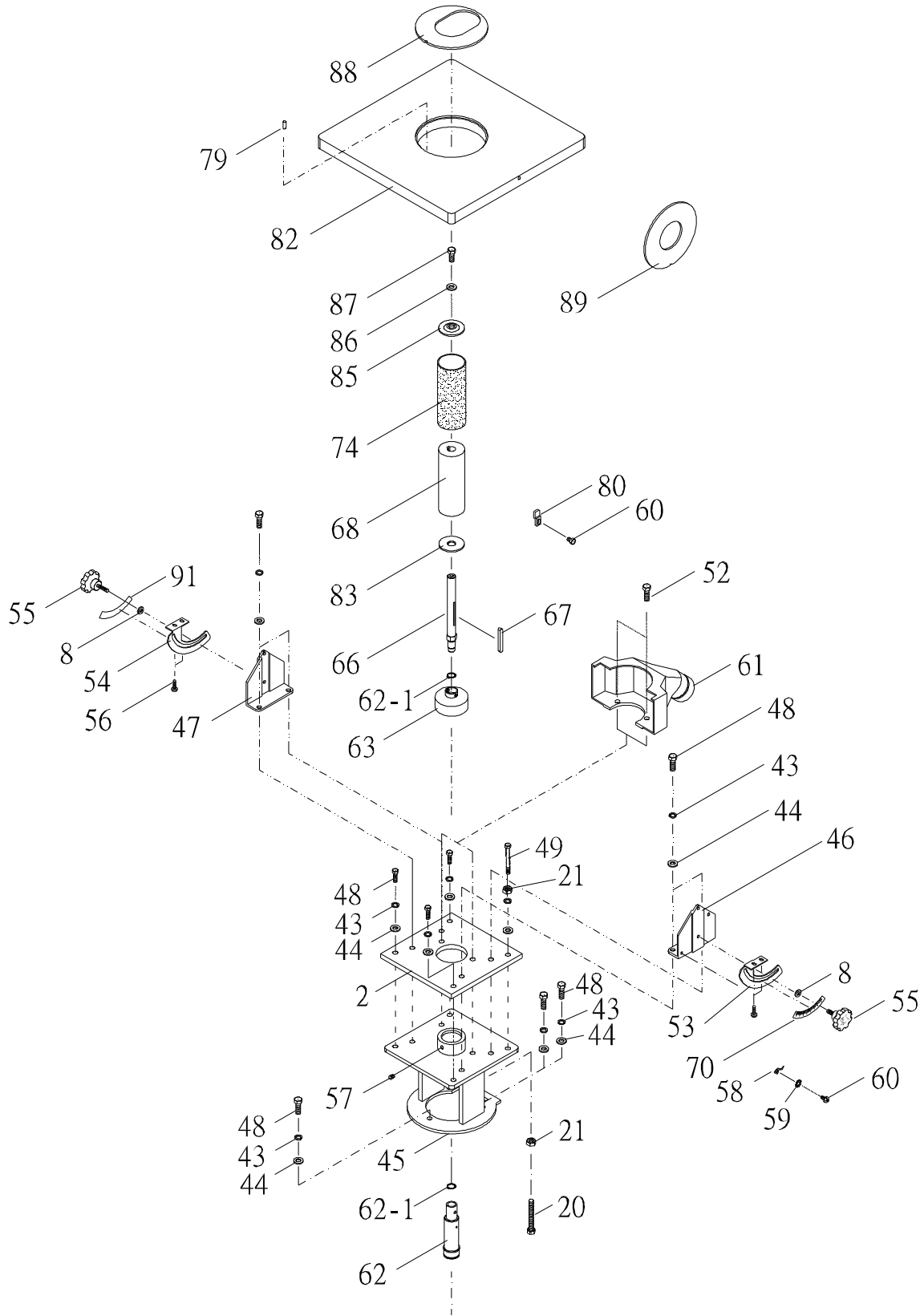

Base and Motor Assembly for the JBOS-5

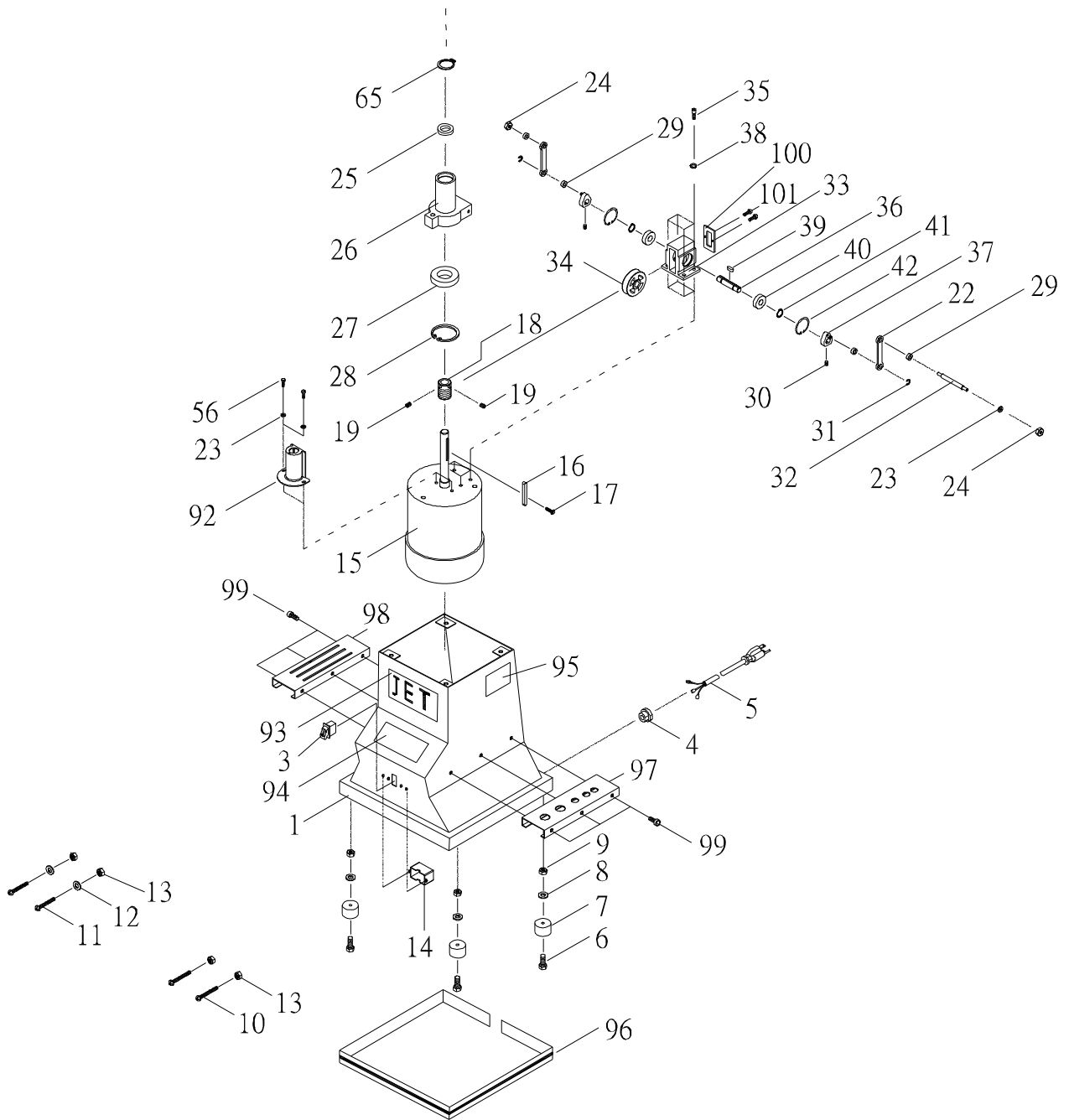

Parts List for the JBOS-5

Index No.	Part No.	Description	Size	Qty
1	6286914W	Base		1
2	6286891	Top Plate		1
3	JBOS5-03	On/Off Switch		1
4	6286915	Strain Relief Bushing		1
5	6286916	Power Cord		1
6	6286485	Phillips Pan Head Screw	M6x22mm	4
7	6286918	Rubber Feet		4
8	6286919	Washer	1/4"	6
9	6286486	Hex Nut	M6	4
10	6286921	Phillips Pan Head Screw	3/16"-24x1-3/4"	2
11	6286922	Phillips Pan Head Screw	3/16"-24x3/4"	2
12	6286923	Gear Washer	3/16"	4
13	6286924	Hex Nut	3/16"-24	4
14	JBOS5-14	Switch Box		1
15	6286912	Motor	1/2 HP	1
16	6286926	Key	6x6x50 mm	1
17	6286927	Flat Head Screw	M4x10	2
18	6286928	Worm Shaft		1
19	6012098	Set Screw	M5x0.8Px5	2
20	6286930	Transmission Rod		1
21	6286931	Hex Nut	M8	2
22	6286932	Connecting Rod		2
23	6286933	Washer	1/4"	4
24	6286488	Nylon Nut	M5	2
25	BB-6804	Ball Bearing	6804-2RS	1
26	6286470	Transmission		1
27	BB-6006ZZ	Ball Bearing	6006ZZ	1
28	6286938	C-Snap Ring	R60	1
29	6286939	Bushing		4
30	6286481	Set Screw	M5X6	2
31	6286482	E-Ring	ETW-4	2
32	6286471	Connecting Shaft		1
33	6286472	Bracket		1
34	6286473	Worm		1
35	6286490	Hex Socket Cap Screw	M6x15	4
36	6286476	Shaft		1
37	6286480	Crank Shaft		2
38	6286474	Spring Washer	1/4"	4
39	6286475	Key	4x4x15 mm	1
40	BB-6001ZZ	Ball Bearing	6001ZZ	2
41	6286478	C-Snap Ring	S12	2
42	6286479	C-Snap Ring	R28	2
43	6286483	Spring Washer	5/16"	11
44	6286484	Flat Washer	5/16"	11
45	6286948	Housing		1
46	6286949	L-Type Bracket-Right		1
47	6286950	L-Type Bracket-Left		1
48	6286951	Screw	M8x25	11
49	JBOS5-49	Hex Cap Screw	M8x110	1
52	6286951	Screw	M8x16	2
53	JBOS5-53	Support Trunnion-Right		1
54	JBOS5-54	Support Trunnion-Left		1
55	JBOS5-55	JET Lock Knob	M6x15	2
56	JBOS5-56	Hex Socket Cap Screw	M5x15	6
57	6286492	Set Screw	M6x5	1
58	6286961	Pointer		1
59	6286493	Gear Washer	1/4"	1
60	6286963	Round Cross Head Screw	M5x10	4
61	6286964	Dust Cover		1

Index No.	Part No.	Description	Size	Qty
62	6286894	Main Spindle serial #2014090 & lower		1
	6286894N	Main Spindle serial #2024091 & higher		1
62-1	S0520020	C-Ring		1
63	6286967	Cover		1
65	JBOS5-65	C-Snap Ring	S28	1
66	JBOS5-66	5/8" Sanding Spindle	1/2"-12UNC, LH	3
	JBOS5-71	1/2" Sanding Spindle (not shown)	1/2"-12UNC, LH	1
	JBOS5-72	1/4" Sanding Spindle (not shown)	1/2"-12UNC, LH	1
67	JBOS5-67	Key	6x6x50 mm	2
68	6286904	2" P.V.C Bushing		1
	6286903	1-1/2" P.V.C Bushing (not shown)		1
70	JBOS5-70	Scale Label		1
74		Sanding Sleeve (see page 10)		1
79	6286495	Spring Pin	3x12 mm	1
80	6286796	5/8" Clamp		1
	6286795	1/2" Clamp (not shown)		1
	6286794	1/4" Clamp (not shown)		1
82	6286973W	Table		1
83	6286798	2" Lower Follower Plate		2
	6286974	1-1/2" Lower Follower Plate (not shown)		1
85	6286799	2" Upper Follower Plate		1
	6286976	1-1/2" Upper Follower Plate (not shown)		1
86	6286977	Washer	5/16"	3
87	6286978	Hex Nut	5/16"	3
88	6286979	Oblong Table Insert (for 1-1/2" and 2" spindles)		1
89	6286980	Round Table Insert (for 1-1/2" and 2" spindles)		1
	6286981	Oblong Table Insert (for 1/4" to 1" spindles), not shown		1
	6286982	Round Table Insert (for 1/4" to 1" spindles), not shown		1
92	JBOS5-92	Oil Cap		1
93	JBOS5-93	JET Label		1
94	JBOS5-94	Warning Label		1
95	JBOS5-95	I.D Label		1
96	JBOS5-96	Stripe		1
97	JBOS5-97	Storage Plate for Drums		1
98	JBOS5-98	Storage Plate for Table Inserts		1
99	TS-1514011	Hex Socket Cap Screw	M6x12	6
100	JBOS5-100	Oil Cover		1
101	JBOS5-101	Pan Head Screw	3/16"x1/4"	2
	JBOS5-105	Open End Wrench (not shown)	14-17mm	2
	JBOS5-106	Open End Wrench (not shown)	10-12mm	1
	709530	Hardware Kit (not shown)		1
	30203000A	1/4" Spindle Assembly (includes #60,66,80)		1
	30203000B	1/2" Spindle Assembly (includes #60,66,80)		1
	30203000I	5/8" Spindle Assembly (includes #60,66,80)		1
	30203000D	1-1/2" Spindle Assembly (includes #66-68 and 85-87)		1
	30203000E	2" Spindle Assembly (includes #66-68 and 85-87)		1



WALTER MEIER (Manufacturing) Inc.

427 New Sanford Road
LaVergne, Tennessee 37086
Phone: 800-274-6848
www.jettools.com
www.waltermeier.com