



POST HOLE DIGGER BE-PHDXG



OPERATIONS & PARTS MANUAL

FOR MODELS:

- BE-PHD6G
- BE-PHD9G

PURCHASE DATE	MODEL NO.	SERIAL NUMBER
DEALER		

TABLE OF CONTENTS

3	IMPORTANT SAFETY INFORMATION
4	SAFETY DECALS
6	ASSEMBLY PARTS LIST
7	OPERATING INSTRUCTIONS
9	MAINTENANCE
10	PARTS LIST

IMPORTANT SAFETY INFORMATION

Before You Begin...

Safety is a primary concern in the design and manufacturer of our products. However, the final responsibility for safety rests with the operator of this machine. This is a powerful piece of machinery. If used improperly, serious injury or death may result. It is essential that everyone involved in the operation, transport, maintenance and storage of this equipment be aware, prudent and properly trained in order to prevent accidents!



Throughout this manual you will see this symbol to alert you of the safety warnings. Read all safety information on this page and throughout this manual before you operate the digger.

- Always wear appropriate and belted clothing to avoid entanglement in moving parts.
- Wear sturdy, rough-soled work shoes. Never operate tractor or digger in bare feet, sandals or sneakers.
- Always wear approved protective equipment to protect eyes and hands during operation or servicing.
- Never allow children or untrained personnel to operate this equipment.
- Never permit any person other than the operator to ride aboard the tractor at any time. ALLOW NO RIDERS.
- Never use alcoholic beverages or drugs which can hinder alertness or coordination while operating this equipment. Consult your doctor about operating this machine while taking prescription medications.
- Keep clear of rotating driveline and auger to avoid high probability of death or irreparable injury.
- Turn off the tractor and remove the key before working on the digger.
- Keep shields and guards in place and in good condition.
- Replace any labels immediately if damaged. Clean label area with soap and water. Remove any dirt, grease or remnants of old safety signs and place pressure-sensitive safety signs in same locations as original safety signs.
- Always operate power take off (PTO) at or below recommended speed of 540 RPM.
- Do not operate PTO during transport.
- Always comply with all state and local lighting requirements when transporting on highways. Be sure that the safety triangle, slow moving vehicle (SMV) is not blocked by the digger when transporting.
- Do not reach or place yourself under equipment until it is blocked securely

CAUTION:

Please read all safety information on the preceding page and all safety notices throughout this manual before assembling, operating, transporting or removing the digger from your tractor.

DANGER:

This warns of an extreme hazard which would result in the high probability of death or irreparable injury if proper precautions are not taken.

WARNING:

This warns of a hazard which would result in the high probability of death or irreparable injury if proper precautions are not taken.

CAUTION:

This directs attention to unsafe practices which could result in personal injury or damage to machinery if proper precautions are not taken.

⚠ SAFETY DECALS:

This is a powerful piece of machinery. If used improperly, serious injury or death may result. Study the safety signs which appear below. They are located on the appropriate parts of the Digger. If the safety signs on this page do not appear on your new or used digger, or if they become mutilated, please order new safety signs.



Caution label:
Located on boom.
Warns of dangers of operating PTO at speeds higher than 540 RPM.



Danger label:
Located on boom.
Warns of dangers of operating digger improperly.



Danger label:
Located on boom mounting plate.
Warns of dangers of attaching implement improperly.



Danger label:
Located on boom.
Warns of dangers of coming in contact with driveline and auger.



Danger label:
Located on auger assembly.
Warns of dangers of operating digger without safety shields.



Danger label:
Located on driveline under shield.
Warns of dangers of operating digger without safety shields



Danger label:
Located on driveline.
Warns of dangers of rotating drivelines.

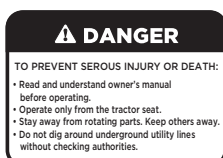

Danger label:
Located on boom.
Warns of dangers of operating digger improperly.

⚠ WARNING

- Do not reach or place yourself under equipment until it is blocked securely.
- Be sure the safety shield over the PTO stub shaft on the gear box and auger is not removed from the digger.

⚠ CAUTION

For safety, turn off before attaching the auger assembly to the gear box. Remove the key to prevent the possibility of someone else starting the tractor.

⚠ DANGER

Never use any bolt longer than 3-1/2" to mount the auger assembly to the gear box.

⚠ WARNING

When attaching PTO yoke to tractor's PTO shaft, be sure that the yoke is secured to the PTO shaft.

Before you begin...

- Check over all pins, bolts and connections to be sure all are securely in place.
 - Nuts and bolts should be snugged with wrenches; cotter pins should be in place and bent over or flared out with pliers.
 - The twist collar at the splined PTO union should be secure.
 - The PTO shaft should be bolted and pinned with the roll pin at the gear box.
 - Replace any safety shields that may have been removed during installation.
1. Lay out all of the parts for assembly. Attach the gear box to the boom assembly with clevis pin and insert cotter pin into the clevis pin. Attach tractor end of boom assembly to the third point of tractor. Make sure that the stabilizer arms on tractor are in place. Now attach the U-frame assembly to the lift arms on the tractor. With the pin in place, raise the boom assembly and attach the U-frame assembly to the boom assembly by inserting bolt (3/4" x 2-3/4" through the ears of the U-frame assembly and the mounting plate on the boom assembly. Secure the bolt with locknut.
 2. Check the clearance and reposition if necessary.
 3. Use the tractor hydraulics to raise the Digger assembly to a height where the auger assembly can be attached. Use bolt and nut to attach assembly to the Digger.
 4. Raise the digger so that the auger is not touching the ground. Now insert PTO shaft onto tractor end. You should now connect the other end of the PTO shaft to the gear box shaft and insert the shear bolt into the 5/16" hole. Secure shear bolt with locknut. Insert roll pin into PTO shaft yoke at the gear box input shaft. 5) The Digger is now ready for use. The final equipment can be made depending on field conditions

DIGGER ASSEMBLY PARTS LIST

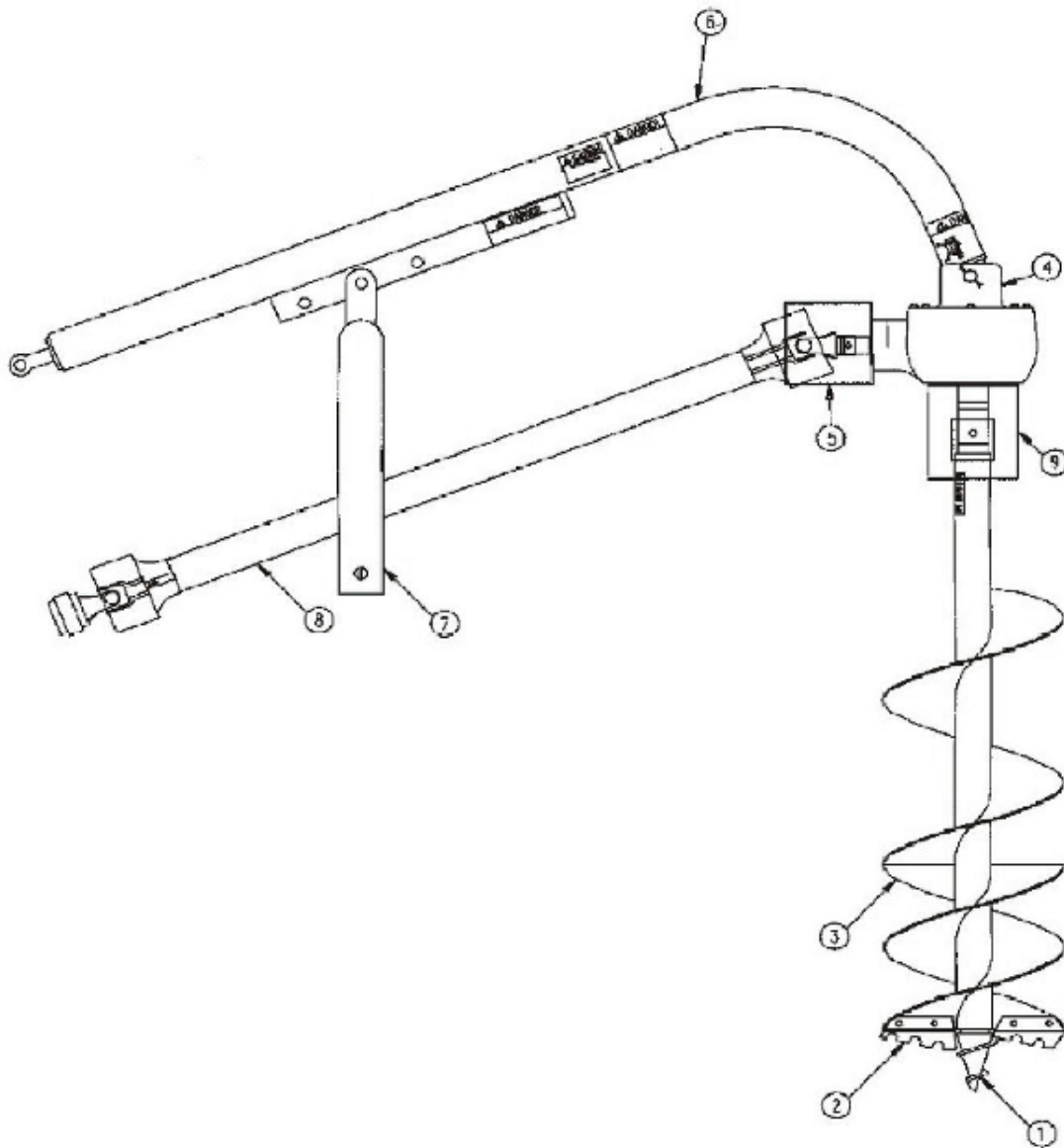

REF	PART NUMBER	DESCRIPTION
1	PHD1G	Spiral Auger Point
2	PD-24567-E 6"	Serrated Edge Kit
	PD-24577-E / PD-24578-E 9"	
	PD-24587-E / PD-24588-E 12"	
3	PHA6G	Auger Assembly (Auger Sold Separately)
	PHA9G	
	PHA12G	
4	PHDG4	Gear Box Assembly
5	PHD2G	Safety Shield Input
6	PHD6G	Boom Assembly
7	PHD14G	U-Frame Assembly
8	69.777.053	PTO Drive Shaft
9	PHD3G	Safety Shield Output

OPERATING INSTRUCTIONS

⚠ SAFETY NOTES

Before operating the Digger, read all safety precautions on the previous pages of this manual and the following specific safety precautions.

⚠ DANGER:

- Stay on the tractor seat while operating Digger. Serious personal injury may result if any attempt is made to assist Digger operation by hand.
- Keep your clothing, yourself and others clear of rotating driveline and auger. Entanglement will cause personal injury or death.
- Allow Digger to stop completely and disengage PTO from tractor before contacting the auger.
- Keep shields and guards in place and in good condition.
- Do not climb into Digger or exert downward force manually.
- Be sure driveline are securely attached at both ends and that driveline shields turn freely on driveline.
- Do not operate PTO when the angle created between the earth and the drive shaft exceeds 45 degrees. If the PTO shaft breaks or the universal joint fails, causing the PTO to rotate without support at both ends, injury may result.

⚠ WARNING:

- Turn off tractor and remove key before working on Digger.
- Allow no children or unqualified persons to operate this equipment.
- Never permit any person other than operator to ride or board the tractor at any time. **ALLOW NO RIDERS.**
- Never use alcoholic beverages or drugs which can hinder alertness or coordination while operating this equipment.

⚠ CAUTION:

- Be sure auger is completely removed from hole before moving tractor.
- Before you operate the Digger, check over all pins, bolts and connections to be sure all are securely in place.
- Always operate PTO at or below recommended speed of 540 RPM. Higher speeds can cause equipment failure and personal injury.

DIGGER OPERATION

1. Move and Position:
The auger will hang in an approximate vertical position when raised clear off the ground. With the Digger clear of the ground, drive the tractor into position above the spot where you wish to dig.
2. Engage Drive:
With the tractor engine idling at low RPM, engage the PTO.
3. Lower Digger:
With the 3PT hitch, lower the Digger and allow it to dig to a depth of about one foot.
4. Clear Auger:
With the power still engaged and the auger turning, slowly raise the boom to lift the auger out of the hole. This will clear the auger, depositing the earth around the hole.
5. Lower Digger:
Lower the Digger again and allow it to dig another foot deeper. Then repeat the steps of boring and clearing until you have reached the desired depth.

SPECIAL OPERATING CONDITIONS

LOOSE OR SANDY SOIL

In loose or sandy soil, you may get a cleaner hole if you stop the auger before lifting it from the hole and start it again as soon as it clears the hole. This will throw the soil out away from the hole.

WET CLAY / OBSTACLES

In wet clay, be careful not to let the auger dig too deep or it may get stuck. If you do get the auger stuck in wet clay or if it stalls against roots or stones, turn off the tractor.

⚠ DANGER:

Keep clear of the driveline until it stops completely. Entanglement will cause personal injury or death.

Remove the PTO drive shaft from the gear box. Turn the auger post counter-clockwise with a large pipe wrench. One complete reverse turn will usually free the Digger.

Restart the tractor and lift slowly with the tractor hydraulics to free the auger from the ground.

If the auger is still stuck, turn off the tractor and use a shovel to dig down and free the auger.

Once the auger is free from the ground, reconnect the PTO drive shaft and you are ready to start digging holes again.

If the shear bolt has sheared, it will need to be replaced.

⚠ WARNING:

Do not install a mounting bolt longer than 3-1/2". A longer mounting bolt will protrude on the turning auger possibly hitting the shield and causing a safety hazard. (See cautions and instructions for shear protection in the maintenance section of this manual).

REMOVING DIGGER

⚠ WARNING:

Read all safety warnings and precautions on the previous pages of this manual, as well as the specific safety precautions below:

- Turn off the tractor and remove the key before removing the Digger
- Do not operate PTO when the angle created between the earth and the drive shaft exceeds 45 degrees. If the PTO shaft breaks or the universal joint fails, the PTO may rotate without support at both ends, resulting in personal injury and damage to the equipment.

⚠ CAUTION:

- Be sure auger is completely removed from hole before moving tractor.

1. To remove the Digger from the tractor, disconnect the PTO shaft from the tractor by turning the twist collar. Remove PTO shaft from gear box by removing the shear bolt and roll pin.
2. Remove the auger assembly by removing the nut and bolt holding it on the shaft.
3. Using the tractor hydraulics, lower the boom as low as it will go.
4. Remove the nut and bolt that hold the U-frame to the boom assembly mounting plate.
5. Hold up the boom with one hand and carefully swing the U-frame down to the ground with your other hand.
6. Lower the boom to the ground (with gear box attached).
7. Remove the boom assembly and U-frame assembly from the 3PT hitch on the tractor by removing the spring clips and pins.
8. Replace the protective guard back over the tractor's PTO shaft for safety and to keep out dirt and water.
9. Clean all mud and dirt from the auger before long term storage to prevent rust and corrosion. Store PTO shaft and gear box attached to the boom assembly if desired. Be sure all small parts and fasteners are kept together for convenient reassembly later.

MAINTENANCE

⚠ SAFETY NOTES

Before operating the Digger, read all safety precautions on the previous pages of this manual and the following specific safety precautions.

⚠ DANGER:

- Always use approved personal protective devices (such as eye, hand and hearing protectors), while performing service or during operation.
- Turn off the tractor and remove the key before working on the Digger.
- Be sure that no bolt longer than 2-1/2" is used for PTO connections. Be sure that no bolt longer than 3-1/2" is used at the auger/gearbox connection. Longer bolts will protrude, hitting the safety shield and causing a safety hazard.

⚠ CAUTION:

Be sure that all hardware is tight and in place.

GENERAL MAINTENANCE

- Nuts and bolts should be snugged with wrenches; cotter pins should be in place and bent over or flared out with pliers.
- The Twist collar at the splined PTO union should be secure.
- The PTO shaft should be bolted with grade 2 bolt and roll pin inserted through the gear box yoke.
- Replace any safety shields that may have been removed during installation.
- Periodically lubricate the PTO shaft universal joints at the grease fittings.

GEAR BOX SERVICE

The gear box uses gear oil. The oil should be checked before the Digger is used.

The capacity is 4.4 pints (70oz.) of EP-140 weight gear oil. Any good quality, multiple grade gear oil such as Shell Spirax 85w-140 HD oil may also be used.

SHEAR PROTECTION

⚠ CAUTION:

The 5/16" x 2-1/2" bolt connecting the PTO shaft to the gear box is a shear bolt. If the auger encounters hard objects, such as large rocks or otherwise, locks up and cannot rotate properly, this bolt is designed to shear to prevent damage to other parts of the machinery.

DO NOT UNDER ANY CIRCUMSTANCES INSTALL A BOLT HARDER THAN GRADE 2. All warranties will be invalid if a bolt harder than Grade 2 is installed.

The roll pin fits across a groove machined around the shaft on the gear box. If the 5/16" shear bolt shears, the mechanism is designed so that the roll pin holds the PTO on the gear box shaft to prevent injuries or damage to the machine. The PTO shaft spins freely on the gear box shaft.

If the bolt shears, the cause of the shear should be determined, the Digger moved from that location and the shear bolt replaced before starting to dig again.

PARTS LIST

GEAR BOX & MOUNTING PIN

REF	PART NO.	DESCRIPTION	SIZE	QTY
1	PHDG4	Gear Box Assembly	-	1
2	PHD2G	Safety Shield Input	-	1
3	PHD3G	Safety Shield Output	-	1
4	PHDBUSH	Bushing	7/8" OD x 3/4" ID x 1-3/8"	2
5	PHDPIN	Stepped Pin	7/8" x 3/4" x 7"	1

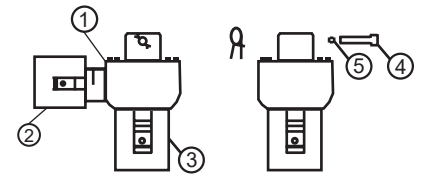

POWER TAKE OFF

REF	DESCRIPTION	SIZE	QTY
6	Yoke (Tractor End)	-	1
7	PTO Shaft Assembly	-	1
8	Cross Journal Assembly	-	2
9	Yoke (Gear Box End)	-	1
10	Shear Bolt (Grade 2)	-	1

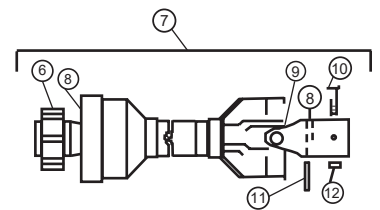

BOOM ASSEMBLY

REF	PART NO.	DESCRIPTION	SIZE	QTY
13	PHD6G	Boom Assembly	2-7/8" Pipe	1

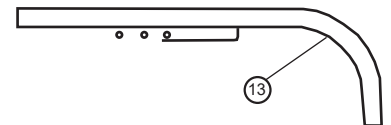

U-FRAME ASSEMBLY

REF	PART NO.	DESCRIPTION	SIZE	QTY
14	PHD14G	U-Frame Assembly	2-7/8" Pipe	1

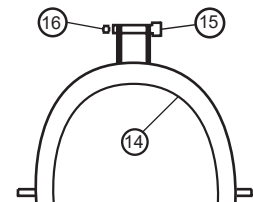

AUGER ASSEMBLY

REF	PART NO.	DESCRIPTION	SIZE	QTY
17	BE-PHA6G	Auger Assembly	6"	1
	BE-PHA9G		9"	1
	BE-PHA12G		12"	1
	-		14"	1
20	PHD1G	Spiral Point Tip	6", 9", 12", 14"	1
21	PD-24567-E 6"	Cutting Edges (Weld-On)	6"	1
	PD-24577-E 9"	Cutting Edge Kit	9"	1
	PD-24578-E 9"			
	PD-24587-E 12"	Cutting Edge Kit	12"	1
	PD-24588-E 12"			
-	Cutting Edge Kit	14"	1	

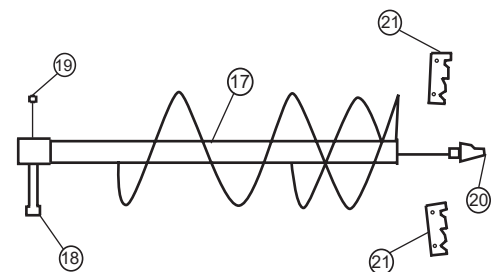

IMPORTANT SAFETY MESSAGE

TO OWNER/ OPERATORS OF POST HOLE DIGGER

Safety is a primary concern in the design, manufacture, sale and use of Post Hole Diggers. As manufacturers of Post Hole Diggers, we want to confirm to you, our customers, our concern for safety. We also want to remind you about the simple, basic and common-sense rules of safety when using a Post Hole Digger. Failure to follow these rules can result in severe injury or death to operators or bystanders.

It is essential that everyone involved in the assembly, operation, transport, maintenance and storage of this equipment be aware, concerned and properly trained in safety. The majority accidents involve entanglement on the driveline or auger. This entanglement risk becomes greater when you replace our shear bolts with bolts longer than those specified by the manufacturer. This improper replacement occurs most often on machines that are loaned or rented to someone who has not read the owner's manual and is not familiar with a Post Hole Digger.

Our current production machines include, as standard equipment, guards or shields for auger adapters, drivelines, input shafts and safety signs. Older machines can be retrofitted to add these new guards or shields and safety signs. If you have an older machine which does not have current standard safety equipment, please contact your dealer about bringing your machine up to the current level safety.



Below are some of the most important safety rules to be understood and followed by anyone who works with Post Hole Diggers:

- Before operating a Post Hole Digger, an operator must read and understand all the information in the owner's manual and in the safety signs attached to the product. A person who has not read or understood the owner's manual or current production safety signs, contact your local dealer immediately.
- Post Hole Diggers are designed for one-man operation. You must always dig holes while sitting in the tractor seat. Never operate the Digger with anyone near or in contact with any part of the implement, PTO driveline or auger. Accidents have occurred when more than one person is in the immediate area of the operating equipment. Be sure no one else, including bystanders, is near you when you operate this product.
- Do not operate the Digger unless all shields and guards are in place.
- Never replace the shear bolt or auger retaining bolt with one longer than those supplied and specified by the manufacturer. See your owner's manual.
- Do not use Digger unless auger point and cutting edges are intact and in good working order.

Following these simple, basic safety rules as well as others identified in the owner's manual and in product safety signs will help minimize the possibility of accidents and increase your productivity in using this product.

Be careful and make sure that everyone who operates the Digger knows and understands that it is a very powerful piece of machinery, and if used improperly, serious injury or death may result. The final responsibility for safety rests with the operator of this machine.



BRABEREQ.COM
WGSALLES@BRABEREQ.COM

PHONE: 604-850-7770
FAX: 604-850-7774
TOLL FREE PHONE: 1-877-588-3311
TOLL FREE FAX: 1-800-665-7334