



Electric Backpack Sprayer

OWNER'S MANUAL



⚠ CAUTION: Read and follow all instructions

Do Not Return This Sprayer To The Store
For Help, Information or Parts, Call : 1-800-311-9903

Item# 113767

▲ SAFETY PRECAUTIONS

- User must read and understand entire instruction manual before operating this Sprayer.
- Never use flammable or combustible liquids, caustics, acids, or hot water in this Sprayer.
- Always wear appropriate personal protection equipment as instructed by chemical manufacturer when using, preparing, handling, spraying, or disposing of chemicals. This includes at least goggles, gloves, and protective clothing.
- Read and follow all instructions and cautions on label of products used in this Sprayer.
- To reduce risk of battery fire or bursts, use only Fountainhead Group Batteries that are in good condition and have not been damaged.
- Do not use Batteries that are wet or have been damaged.
- Inspect Sprayer, Hose, Shut-off, and Wand, for damage or loose connections before each use.
- Do not pressurize with any mechanical device such as an air compressor since this can create a dangerous pressure level and bursting of parts, resulting in serious injury.
- Always use replacement parts from the original manufacturer.
- Never attempt to alter Sprayer from original condition.
- Do not lift or carry the Sprayer by the Hose, Shut-off valve, or Wand. Carry by the Handle only.
- Only spray when the air is calm (no wind or air movement) to prevent chemical spray from drifting into unintended areas.
- Keep the Sprayer and all chemicals out of the reach of children.
- Remove chemicals and thoroughly clean the Sprayer after each use. Failure to clean the Sprayer may cause contamination of subsequent applications, will cause premature Sprayer wear, and void the Sprayer warranty.

ABOUT THIS SPRAYER

WARNING: RISK OF FIRE, BURNS, OR ELECTRICAL SHOCK. To reduce the risk of injury, user must read and understand entire instruction manual before operating this Sprayer.

This is an electric-powered backpack style Sprayer that is designed to spray water soluble solutions, such as herbicides, pesticides, and other liquid chemicals typically used for weed prevention, weed remediation, pest control, fertilizing, and watering.

This Sprayer uses a rechargeable Lithium-Ion Battery to power an electric diaphragm Pump, eliminating the need for manual hand-pumping. Lithium-Ion Batteries are shipped in a reduced-charge state, and must be charged prior to initial use. The Pump directly pumps the liquid contents from the Tank, through the Hose, Shut-off, Wand, and Nozzle to create spray. Because the Pump directly pumps the liquid, it does not create pressure inside the Tank.

To maintain optimal Pump and Battery life this Sprayer is designed to turn off the Pump when not spraying. Because of this the Pump will turn on and off periodically during normal use. Typically the pump will turn on when the Shut-off is opened (Lever depressed) and turn off when the Shut-off is closed (Lever released). This is achieved via a pressure switch. If no liquid is present in the system then pressure can't increase so the pump will not turn off. Ensure that the Power Switch is set to the OFF position whenever the Tank is empty. Also see *Cleaning & Storage*.

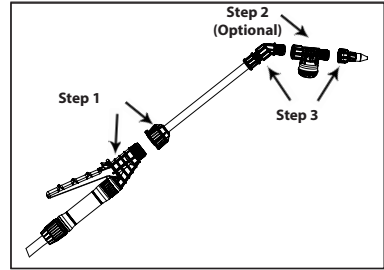
In cases where after-market ultralow-flow nozzles are used, the Pump may turn on and off more frequently, even when the Shut-off is open (Lever depressed). This is normal and is due to the use of an ultralow-flow nozzle with the high-performance pump.

Do not return sprayer to store, if you experience problems or have questions contact our toll free Customer Service Center, M-F 8AM - 5PM, EST, at 1-800-311-9903, or e-mail: Info@TheFGI.com, or access online at: www.TheFountainheadGroup.com.

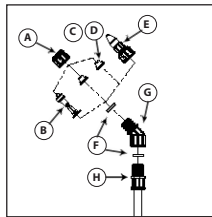
ASSEMBLY INSTRUCTIONS

Assemble Extension, Shut-Off, Nozzle and Spray Optimizer


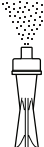


1. Install the extension "wand" onto the shut-off assembly and tighten the nut securely.
2. (Optional) Install Spray Optimizer for low pressure (low drift) applications. This will help prevent weed killer formulas from drifting into undesired areas. (**Do not over tighten, actual position will vary.**)
3. Install selected nozzle onto the end of the extension or optimizer (if installed) and tighten securely.



SELECT USING NOZZLE CHART BELOW
(Nozzle selections vary by model)



- A. Cap Nut
- B. Foaming Nozzle
- C. Red High-Volume Fan Nozzle
- D. Yellow Low-Volume Fan Nozzle
- E. Adjustable Cone Nozzle
- F. Flat Seal
- G. Adapter
- H. Wand

<p>ADJUSTABLE CONE USES:</p>  <ul style="list-style-type: none"> • Spot spraying in or around flowerbeds, trees and shrubs. • Edging along fences, driveways and walkways. • Killing brush such as poison ivy, poison oak, kudzu and wild blackberry. • Preparing garden beds for planting of ornamentals and vegetables. <p><i>Turn to adjust spray pattern.</i></p>	<p>FOAMING NOZZLE USES:</p>  <ul style="list-style-type: none"> • Spot spraying in or around flowerbeds, trees and shrubs. • Edging along fences, driveways and walkways. • Killing brush such as poison ivy, poison oak, kudzu and wild blackberry.
<p>RED HIGH VOLUME FAN NOZZLE USES:</p>	<p>YELLOW LOW VOLUME FAN NOZZLE USES:</p>
 <ul style="list-style-type: none"> • Lawn replacement. Kill lawn and weeds before planting a new lawn. • Preparing large areas for planting of ornamental and vegetable gardens. 	 <ul style="list-style-type: none"> • For precision spraying in confined areas such as gardens and flower beds.

OPERATING INSTRUCTIONS

WARNING: RISK OF FIRE, BURNS, OR ELECTRICAL SHOCK. Use Charger only in a dry, dust-free location free from any flammable or combustible liquids or vapors. Use only with Fountainhead Group Batteries – Other types of batteries may burst causing personal injury and damage. Do not short circuit the Charger or Battery terminals. Do not charge damaged Batteries. Do not expose to liquid, vapor, or rain.

Slow Charger Instructions (for Sprayers so equipped):

1. The Slow Charger can be used to charge either the 2.0Ah or 4.0Ah Battery (18V), but will only charge at the slow rate. To reduce charging time of a 4.0Ah Battery, it is recommended to use a Fast Charger to charge a 4.0Ah Battery.
2. In a covered, dry, dust-free location, insert the Charger Plug into a 120VAC wall outlet. The light on the Charger Body should turn red and stay on, indicating it is connected to power.
3. If not already done, remove the Battery from the Sprayer by following instructions in *Removing the Battery*.
4. Fully slide the Charger Body onto the Battery. The light on the Charger Body should flash red twice to indicate the Battery is connected. The light will then change to flashing green to indicate it is correctly charging.



Slow Charger

- a. If the red light remains steady and the green light does not start flashing, the Charger is unable to recognize the Battery and begin charging because the Battery has been damaged. If this happens the Battery must be replaced.
 - b. If the light on the Charger Body continues to flash red only, the Battery is too hot to be safely stored in a very hot location (such as in an enclosed vehicle or storage unit during very hot weather.) If this happens the Battery must be allowed to cool before it can be charged.
 - c. If the light on the Charger Body flashes red and green alternately, this means the Battery has been damaged and cannot be charged within the safe charging time limit. The Battery must be replaced.
5. Ensure the Battery and Charger are placed where they will not be exposed to liquids, falls, or other sources of damage for the duration of the charging period.
 6. When charging is complete the light will remain green and stay on constantly. Charging time will vary depending on Battery condition at the start of charging. Charging time for a 2.0Ah Battery should not exceed 3.5 hours. Charging time for a 4.0Ah Battery should not exceed 8 hours.
 - a. If the light on the Charger Body flashes red and green alternately, this means the Battery has been damaged and cannot be charged within the safe charging time limit. The Battery must be replaced.
 7. Remove the Battery from the Charger after it is fully charged. Batteries should not be stored on the Charger. To ensure optimal Battery life the Battery should be charged at least once every 3 months when not in use.
 8. Unplug the Charger from the outlet when not in use.

OPERATING INSTRUCTIONS CONTINUED**Fast Charger Instructions (for Sprayers so equipped):**

1. The Fast Charger can be used to charge either the 2.0Ah or 4.0Ah Battery (18V), and is capable of charging at different rates depending on which Battery is being charged. The Fast Charger will automatically recognize which size Battery (2.0Ah or 4.0Ah) has been connected, and charge it accordingly.
2. In a covered, dry, dust-free location, insert the Charger Plug into a 120VAC wall outlet. The red light on the Charger Body should turn on and stay on, indicating it is connected to power.
3. If not already done, remove the Battery from the Sprayer by following instructions in *Removing the Battery*.
4. Fully slide the Battery onto the Charger until it latches into place. The red light on the Charger should flash red twice to indicate the Battery is connected, and then remain on. The green light will then start flashing to indicate it is correctly charging.



Fast Charger



- a. If the red light remains steady and the green light does not start flashing, the Charger is unable to recognize the Battery and begin charging because the Battery has been damaged. If this happens the Battery must be replaced.
- b. If the red light on the Charger continues to flash red, and the green light remains off, the Battery is too hot to be safely charged. This can happen when the Battery is used heavily in very hot weather or if the Battery is improperly stored in a very hot location (such as in an enclosed vehicle or storage unit during very hot weather.) If this happens the Battery must be allowed to cool before it can be charged.
- c. If the red and green lights on the Charger flash alternately, this means the Battery has been damaged and cannot be charged within the safe charging time limit. The Battery must be replaced.

5. Ensure the Battery and Charger are placed where they will not be exposed to liquids, falls, or other sources of damage for the duration of the charging period.
6. When charging is complete the green light will remain on and the red light will turn off. Charging time will vary depending on Battery condition at the start of charging. Charging time with either a 2.0Ah or 4.0Ah Battery should not exceed 90 minutes.

- a. If the red and green lights on the Charger flash alternately, this means the Battery has been damaged and cannot be charged within the safe charging time limit. The Battery must be replaced.

7. Remove the Battery from the Charger after it is fully charged, by depressing the Battery Latch and sliding the Battery off the Charger. Batteries should not be stored on the Charger. To ensure optimal Battery life the Battery should be charged at least once every 3 months when not in use.
8. Unplug the Charger from the outlet when not in use.

OPERATING INSTRUCTIONS CONTINUED**Filling the Sprayer:**

WARNING: RISK OF DEATH, PERSONAL INJURY AND/OR PROPERTY DAMAGE FROM IMPROPER CHEMICAL USE OR MIXTURE. Never use flammable or combustible liquids, caustics, acids, or hot water in this Sprayer. Spraying flammable or combustible liquids can create combustible fumes that could be ignited by the electrical system in the Sprayer, causing an explosion. Always refer to chemical manufacturer instructions for proper mixture. Always wear appropriate personal protection equipment as instructed by chemical manufacturer when using, preparing, handling, spraying, or disposing of chemicals. This includes at least goggles, gloves, and protective clothing.

CAUTION: RISK OF DAMAGE TO INTERNAL COMPONENTS. Use of chemicals other than water based or water soluble solutions may damage the Sprayer and will void the warranty. Do not operate the Sprayer without the In-Tank filter properly installed. Doing so could allow debris to enter the Pump causing clogging or damage to the Pump.

This Sprayer contains two different filters: a Strainer Basket located in the top opening of the Tank to remove coarse debris such as leaves and grass, and an In-Tank Filter located inside the Tank at the bottom to remove fine debris such as dirt and small particles. It is important to prevent debris from entering the Tank as it will require more frequent cleaning and maintenance.

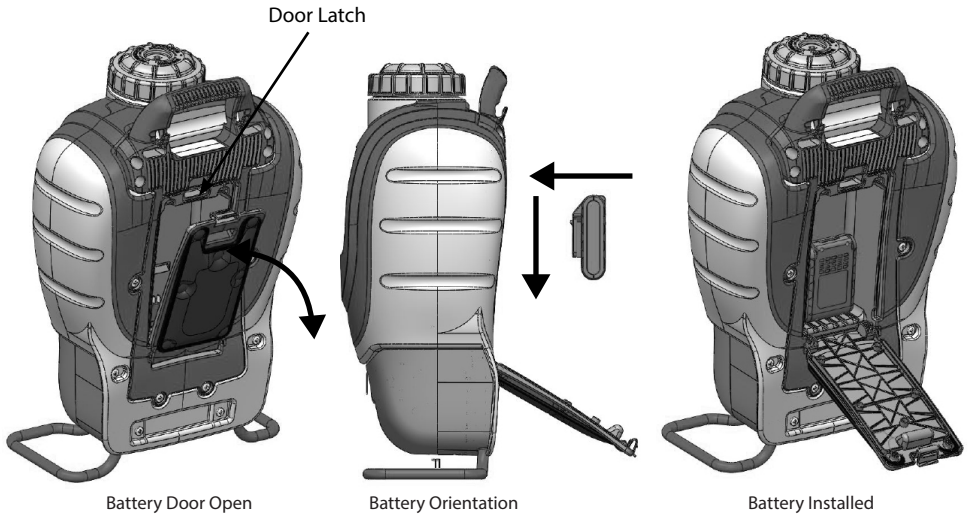
1. Inspect Sprayer, Hose, Shut-off, Wand, and all connections for damage before each use. A damaged Hose or loose Hose connection can result in unintended exposure to the pressurized chemical, resulting in serious injury or property damage.
2. Test Sprayer with plain water before use with chemicals, prior to initial use and after prolonged storage.
3. With the Sprayer on a stable surface ensure the Power Switch is in the OFF (O) position.
4. Remove the Battery from the Battery Compartment before filling the Tank. See *Removing the Battery*.
5. Unscrew the Cap and place it on a clean surface where it will not collect dirt, dust, grass clippings, or other debris.
6. Remove the Strainer Basket and inspect it for debris. Clean the Strainer Basket if needed before filling. Place the Strainer Basket on a clean surface where it will not collect dirt, dust, grass clippings, or other debris.
7. Inspect the Tank interior for debris, and clean as needed. See *Cleaning and Storage*.
8. Check to make sure the In-Tank Filter is in place, the mesh is intact, and it is not clogged with debris. See *Servicing the In-Tank Filter*.
9. Clean the In-Tank Filter if needed.
10. Reinstall the In-Tank Filter and Strainer Basket.
11. Follow the chemical manufacturer's instructions for preparing the chemical. Fill the Sprayer by pouring liquid into the top opening and through the Strainer Basket, to the desired volume, according to the volume graduation markings on the side of the Tank.
12. Clean up any spilled, splashed, or overflowed liquid on the Sprayer before inserting the Battery. See *Inserting the Battery*.

Inserting the Battery:

WARNING: RISK OF FIRE, BURNS, OR ELECTRICAL SHOCK. To reduce risk of battery fire or bursts, use only Fountainhead Group Batteries that are in good condition and have not been damaged. Do not use Batteries that are wet or have been damaged.

CAUTION: RISK OF UNINTENDED SPRAYING. Ensure that the Power Switch is in the OFF (O) position and that the Shut-off is in the closed position (Lever released) before inserting the Battery. The Sprayer will spray when the Battery is inserted if the Power Switch is in the ON (I) position and the Shut-off is open (Lever depressed).

1. With the Sprayer on a stable surface set the power switch into the OFF (O) position.
2. Open the Battery Compartment by pushing down on the Door Latch located at the top of the Door, and swing the Door open and downward.
3. Insert the Battery so that the Battery Button is facing upward and into the Battery Compartment.
4. Slide the Battery down into the Battery Dock so that it engages the Rails and slides in until it latches in place.
5. Ensure the Battery is latched in place by lifting gently upward on the Battery. The Battery should not lift up if properly latched.
6. Close the Door and ensure that the Door Latch (located at the top of the Door) is engaged.

OPERATING INSTRUCTIONS CONTINUED**Removing the Battery:**

1. With the Sprayer on a stable surface set the Power Switch into the OFF (O) position.
2. Open the Battery Compartment by pushing down on the Door Latch located at the top of the Door, and swing the Door open and downward.
3. Depress the Battery Button (located on the top rear surface of the Battery when installed) and lift the Battery approximately 2 inches until it released from the Battery Dock.
4. Remove the Battery from the Battery Compartment.
5. See *Cleaning & Storage* section for Battery storage instructions.
6. See *Charging the Battery* for Battery charging instructions.
7. Close the Door and ensure that the Door Latch (located at the top of the Door) is engaged.

Powering-On and Spraying:

WARNING: RISK OF UNINTENDED SPRAYING AND CHEMICAL EXPOSURE. Ensure that the Shut-off is in the closed position (Lever released) before setting the Power Switch to the ON (I) position. The Sprayer will spray if the Shut-off is open (Lever depressed) when the Power Switch is set to the ON (I) position. Only spray when the air is calm (no wind or air movement) to prevent chemical spray from drifting into unintended areas.

1. A Battery must first be inserted into the Battery Dock in the Battery compartment for the Sprayer to operate. Follow the instructions for *Inserting the Battery*.
2. Set the Power Switch into the ON (I) position. If the Sprayer has not been used recently there will probably be a low, audible hum, indicating the Pump has turned on and is building pressure in the Hoses. If the Sprayer was used recently, and still has pressure in the Hoses, the Pump may not turn on until the Shut-off is opened (Lever depressed).
3. Aim the Wand in the desired direction of spraying and depress the Shut-off Lever.
4. For continuous spraying, depress the Lever and rotate the Lock to hold the Lever in the depressed position.
5. Unlock, if needed, and release the Shut-off Lever to stop spraying.
6. To turn off the Sprayer set the Power Switch into the OFF (O) position.
7. Always remove any chemical, and clean the Sprayer when finished use. See *Cleaning and Storage*.

OPERATING INSTRUCTIONS CONTINUED

Flow Rate and Pressure:

Sprayer flow rates are typically measured in gallons per minute (gpm) or liters per minute (lpm). As with any electric pump, the spraying pressure and flow rate are determined by a combination of the pump performance and nozzle characteristics. Pressure and flow rates can be changed by using different nozzles. This Sprayer contains a pump that is optimized to spray 0.2 gpm at a pressure of 40psi, but is capable of a wide range of pressures and flow rates with little change in Battery life. Pressure and flow rate will vary depending on actual nozzle used. It is the responsibility of the user to select an appropriate nozzle for the desired application.

Some sprayers are equipped with a flow adjustment controller, located near the Power Switch, which allows the user to adjust the Pump performance to meet a desired flow rate or spray pattern intensity. This range of flow rate and spray pattern intensity will vary, depending on performance of nozzle being used.

Determining Actual Flow Rate:

Typical flow rates for this Sprayer range from 0.15 gpm (0.57 lpm) to 0.3gpm (1.13 lpm). The actual flow rate for any nozzle can be measured by spraying into a suitable container for 1 minute, then measuring the volume of liquid (in gallons or liters) in the container. This amount is equal to the flow rate (gpm or lpm).

Battery Charge Indicator:

This Sprayer is equipped with a Battery Charge Condition Indicator. With the Power Switch in the ON (I) position the Battery charge condition can be displayed by pressing the Battery Charge Indicator Button. LED lights, located near the Button will illuminate for 5 seconds to indicate the approximate Battery charge, according to the following meaning:

Number of LED's Illuminated	Charge Remaining
4 LED's	100%
3 LED's	75%
2 LED's	50%
1 LED's	25%
0 LED's	No charge remaining (Battery must be charged in order to use).

NOTE: Actual Battery life will vary depending on spraying technique, liquid sprayed, and nozzle used.

SPRAYER MAINTENANCE

Cleaning & Storage

WARNING: RISK OF PERSONAL INJURY DUE TO CHEMICAL EXPOSURE. Always wear appropriate personal protection equipment as instructed by chemical manufacturer when using, preparing, handling, spraying, or disposing of chemicals. This includes at least goggles, gloves, and protective clothing. Prior to performing maintenance always depressurize Sprayer by setting Power Switch to the OFF (O) position and then opening the Shut-off (depressing the Lever) to spray until liquid flow stops.

CAUTION: RISK OF DAMAGE TO INTERNAL COMPONENTS. Failure to properly rinse out the Sprayer may allow chemical residue build-up that can clog or damage the Filters, Pump, Shut-off, Wand, and Nozzle. Chemical residue build-up can also contaminate subsequent applications. Leaving chemical liquids in the Sprayer when not in use can lead to premature Sprayer wear. Never store Sprayer with chemical in any part of the Sprayer.

1. Set the Power Switch to the OFF (O) position.
2. Remove the Battery. See *Removing the Battery*.
3. Empty any extra chemical from the Tank into a suitable container for later use or disposal according to chemical manufacturer's instructions.
4. Use clean water to thoroughly rinse and empty the Tank until all chemical and residues are removed.
5. Add approximately 1 quart [1 liter] of clean water to the Tank.
6. Insert the Battery. See *Inserting the Battery*.
7. Set the Power Switch to the ON (I) position.
8. With clean water in the clean Tank, spray water through the Pump, Hose, Shutoff, Wand, and Nozzle for at least 30 seconds to rinse them out. Failure to rinse out Pump, Hose, Shutoff, Wand, and Nozzle may allow chemical residue build-up that can clog or damage the components. After heavy use rinsing the Nozzle may not be enough to remove residue. The Nozzle may need to be cleaned with a small brush.
9. Empty out any remaining water from the Tank then continue to spray until water no longer comes out the Nozzle. This indicates that most of the water in the system has been removed.
10. Set the Power Switch to the OFF (O) position.
11. Remove the Battery.
12. Open the Shut-off (depress Lever) to release any remaining pressure in the Hose.
13. Allow the Sprayer to dry. This is best done by removing the Cap and Strainer Basket and hanging the Sprayer upside down to let it drain.
14. Once the Sprayer is dried, turn the Sprayer upright and reinstall the Strainer Basket and Cap to prevent debris from entering the Tank.
15. Store the Sprayer and Battery indoors in a warm, dry location out of direct Sunlight and away from any sources of moisture or intense heat. Do not store Sprayer where freezing temperatures (below 32°F/0°C) will occur. Allowing water to freeze inside the Sprayer may cause damage to the Pump, Seals, Shut-off, or other components, and void the Sprayer warranty.
16. To ensure optimal Battery life the Battery should be charged at least once every 3 months when not in use. See *Charging the Battery*.

Servicing the In-Tank Filter:

CAUTION: RISK OF DAMAGE TO INTERNAL COMPONENTS. Do not operate the Sprayer without the In-Tank Filter properly installed. Doing so could allow debris to enter the Pump causing clogging or damage to the Pump.

1. Ensure the Power Switch is in the OFF (O) position.
2. Remove the Battery from the Battery Compartment. See *Removing the Battery*.
3. Remove the Tank Cap and Strainer Basket. Rinse with clean water to remove any debris. Place the Strainer Basket and Cap on a clean surface where they will not collect dirt, dust, grass clippings, or other debris.
4. Pour any liquid from the Tank into an appropriate container for later use or proper disposal according to chemical manufacturer's instructions.
5. Rinse and empty the Tank to remove any dirt, debris, or residue.

SPRAYER MAINTENANCE CONTINUED

6. Reach into the Tank and carefully grasp the cylindrical Filter located at the bottom of the Tank.
7. Turn the filter approximately 1/8 of a turn counter-clockwise until it stops turning.
8. Pull up on the Filter and remove it from the Tank.
9. The Filter can be cleaned by carefully rinsing from the inside to the outside. Be sure not to tear or damage the mesh. Any damage to the mesh may allow debris to enter the pump and cause clogging or damage to the pump.
10. If the Filter is damaged or too dirty to permit cleaning, it must be replaced with a new Filter.
11. To re-install the Filter gently set it back over the Filter Base in the bottom of the Tank, and slowly turn the Filter until the locking tabs on the Filter Base align with the grooves in the Filter. The Filter will drop downward approximately 1/8 inch when this happens.
12. Push down on the Filter until it stops, approximately another 1/4 inch, then turn the Filter approximately 1/8 turn clockwise until it stops.

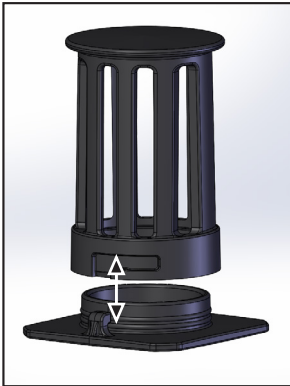
Filter Installation and Removal Process

Figure 1

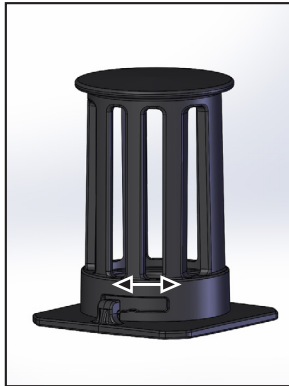


Figure 2

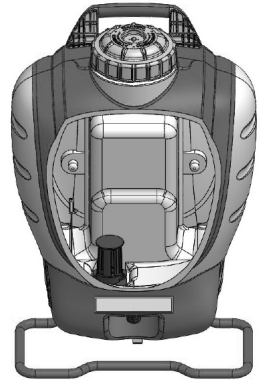


Figure 1: Align notches on Filter with tabs on Base.

Figure 2: Rotate Filter 1/8 turn to lock/unlock.

Harness Installation

1. For each side, remove the small plastic Clips from the two Shoulder Strap loops and thread each loop through the slots at the top of the Carry Handle. Replace the Clips through the loops and pull Strap securing the two Shoulder Straps in place. (See Figure 1)
2. To install lower end of the Straps, remove Strap from top portion of Buckles and place around the Foot Stand, starting from underneath. (See Figure 2)
3. Loop Strap through the first section of Buckle. (See Figure 3)
4. Next loop Strap through other section of Buckle and tighten (See Figure 4). Adjust the Shoulder Pads and Strap length for a comfortable fit.



Figure 1

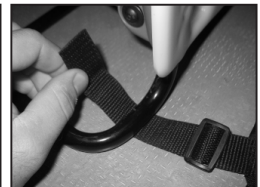


Figure 2

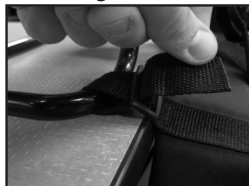


Figure 3

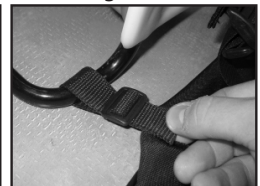
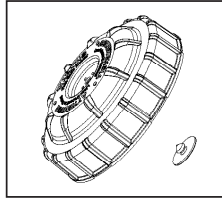
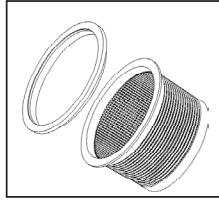
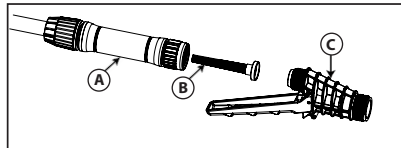


Figure 4

SERVICING INSTRUCTIONS**Figure G****Figure H****Cap and Strainer Basket Maintenance**

1. Check the Check Valve (See **Figure G**) and Strainer Basket gasket (See **Figure H**). Make sure they do not show signs of wear and are operating properly. Replace them as required.



A. Handle
B. Filter
C. Shut-off Assembly

Shut-off Maintenance (Smith Pro)

WARNING: Prior to performing maintenance always depressurize Sprayer by setting Power Switch to the OFF (O) position and then opening the Shut-off (depressing the Lever) to spray until liquid flow stops.

1. Unscrew the Handle from the Shut-off Assembly.
2. Remove the Filter from the Shut-off Assembly.
3. Clean any debris from inside the handle, Shut-off Assembly, or the Filter by rinsing with cool, clean water.
4. Reassemble the components as shown and tighten all connections securely.

Nozzle Maintenance

WARNING: Prior to performing maintenance always depressurize Sprayer by setting Power Switch to the OFF (O) position and then opening the Shut-off (depressing the Lever) to spray until liquid flow stops.

1. If Nozzle clogs, remove and disassemble the Nozzle assembly.
2. Clean the openings of any obstructions or residue. Do not use sharp tools that could scratch or damage the Nozzle as spray pattern could be affected.

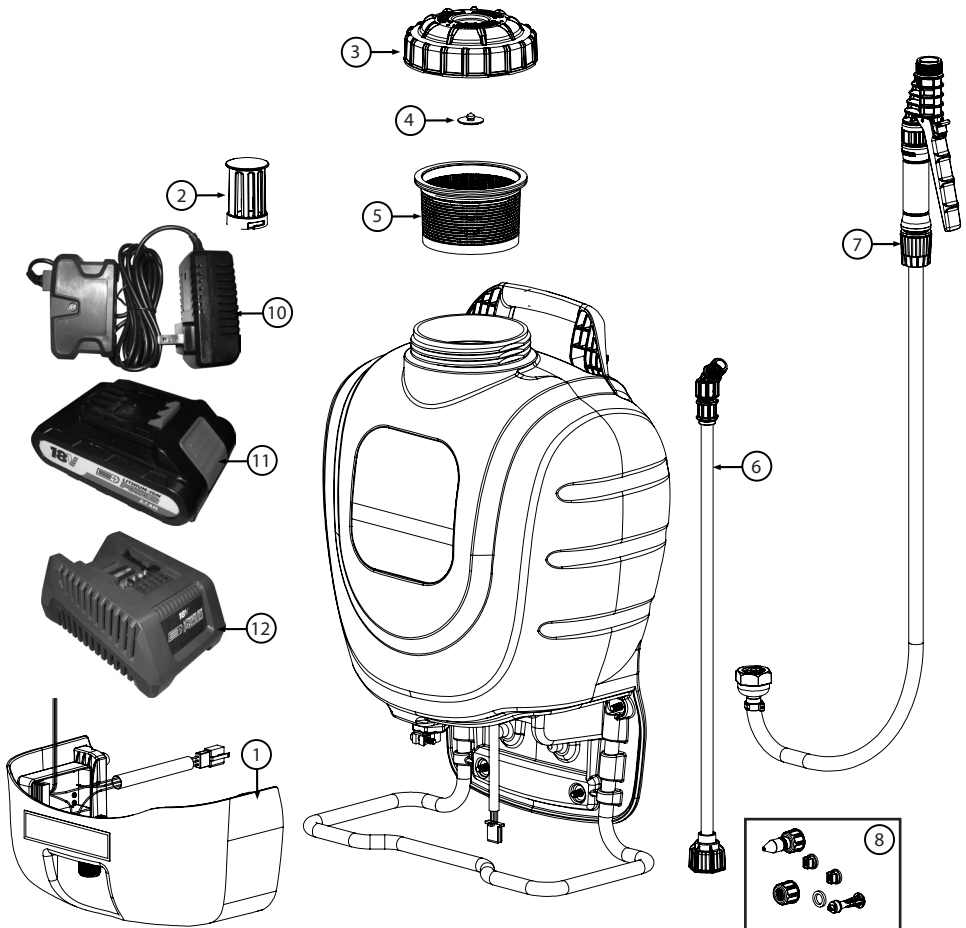
TROUBLESHOOTING

TROUBLE	LOOK FOR	REMEDY
Sprayer will not turn on (no audible hum of the pump.)	<ol style="list-style-type: none"> 1. Battery inserted correctly. See <i>Inserting the Battery</i>. 2. Battery charged. Check Battery condition. See <i>Battery Charge Indicator</i>. 3. Power Switch in the ON (I) position. 4. Battery damaged, over heated, or non-functional? Visually inspect the Battery for damage. Use the Charger to diagnose any Battery problem. See <i>Charging the Battery</i>. 5. Hose is already pressurized so the pump has turned off automatically. 	<ol style="list-style-type: none"> 1. Insert Battery correctly. 2. Charge Battery as needed. See <i>Charging the Battery</i>. 3. Set the Power Switch to the ON (I) position. See <i>Powering-On and Spraying</i>. 4. Replace Battery if damaged or non-functional. Allow Battery to cool if overheated. 5. Open the Shut-off (depress Lever) to see if the Sprayer starts spraying and the Pump turns on.
Sprayer turns on (audible hum of pump heard) but will not spray.	<ol style="list-style-type: none"> 1. No liquid in Tank. 2. Shut-off clogged. 3. Nozzle clogged. 4. Pump not yet primed. 	<ol style="list-style-type: none"> 1. Add liquid to Tank. See <i>Filling the Sprayer</i>. 2. Clean Shut-off. See <i>Shut-off Maintenance</i>. 3. Clean Nozzle. See <i>Nozzle Maintenance</i>. 4. Allow time for pump to prime (up to 30 seconds).
Sprayer turns on but only sprays at low pressure.	<ol style="list-style-type: none"> 1. Shut-off clogged. 2. Nozzle clogged. 3. Pump not yet primed. 	<ol style="list-style-type: none"> 1. Clean Shut-off. See <i>Shut-off Maintenance</i> 2. Clean Nozzle. See <i>Nozzle Maintenance</i>. 3. Allow time for Pump to prime (up to 30 seconds).
Pump will not fully prime.	<ol style="list-style-type: none"> 1. Low liquid level in Tank. 2. Pump was run dry without liquid prior to refilling Tank. 3. Chemical residue build-up in Tank (likely also in Pump) due to improper or inadequate cleaning. 	<ol style="list-style-type: none"> 1. Add liquid to Tank. See <i>Filling the Sprayer</i>. 2. Set Power Switch to OFF (O) position. Open Shut-off (depress Lever) until all pressure is relieved. Set Power Switch to ON (I) position. 3. Clean sprayer. See <i>Cleaning & Storage</i>. If necessary, repeat with warm water and mild detergent mixture, allowing mixture to stay in pump for up to 1 hour prior to rinsing. Replace Pump Unit if necessary.

TROUBLESHOOTING

TROUBLE	LOOK FOR	REMEDY
Pump will not fully prime. <i>(continued from page 12)</i>	4. In-Tank Filter improperly installed, missing, or damaged, allowing debris to enter Pump.	4. Clean sprayer. See <i>Cleaning & Storage</i> . If necessary, repeat with warm water and mild detergent mixture, allowing mixture to stay in pump for up to 1 hour prior to rinsing. Replace Pump Unit if necessary.
Hose Leaks at Tank connection.	1. Cracked, swollen or faulty Hose. 2. Damaged connection.	1. Replace Shut-off Assembly. 2. Replace Shut-off Assembly.
Hose Leaks at Shut-off.	1. Cracked, swollen or faulty Hose. 2. Damaged connection.	1. Replace Shut-off Assembly. 2. Replace Shut-off Assembly.
Nozzle drips when Shut-off Lever is released.	1. Dirt or debris in Shut-off. 2. Damaged O-Ring or Seal in Shut-off.	1. Clean Shut-off Assembly. 2. Replace Shut-off Assembly.
Nozzle Tip leaks	1. Flat Seal missing. 2. Flat Seal damaged.	1. Install Flat Seal behind Nozzle Tip. See <i>Assemble Extension, Shut-off, Nozzle, and Spray Optimizer</i> . 2. Replace Flat Seal.
Poor Spray Pattern	1. Nozzle partially clogged. 2. Nozzle damaged.	1. Clean Nozzle. See <i>Nozzle Maintenance</i> . 2. Replace Nozzle.
Battery will not Charge.	1. No lights illuminated on Charger (not plugged into outlet). 2. No lights illuminated on Charger (plugged into outlet). 3. No lights illuminated on Charger (plugged into outlet, outlet functioning). 4. Red light illuminated on Charger, no green light (Charger cannot recognize Battery). 5. Red light continues flashing on Charger (Battery temperature too high for safe charging). 6. Red and Green lights flash alternately on Charger (Battery cannot be charged).	1. Plug Charger into outlet. 2. Check that outlet is functioning. 3. Replace Charger. 4. Replace Battery. 5. Allow Battery to cool. 6. Replace Battery.

KITS, PARTS & ACCESSORIES



KEY #	PART #	DESCRIPTION
1	183422	PUMP UNIT, S2E
2	183418	IN-TANK FILTER
3	181444	CAP, TANK, SS1
4	171015V	CHECK VALVE, VITON, CA
5	181564	FILTER BASKET ASSY
6	181824	WAND ASSY, 21", PP, SMII
7	183176	HOSE & SHUTOFF ASSY, S2, SMII
8	181870	KIT, BRASS NOZZLES, SMII
9	183420	HARNESS, S2E
10	183417	CHARGER, US, LI-ION, 18V, SLOW
11a	183411	BATTERY PACK, LI-ION, 18V, 2.0AH, BLACK
11b	183412	BATTERY PACK, LI-ION, 18V, 4.0AH, GRAY/BLACK
12	183416	CHARGER, US, LI-ION, 18V, FAST





Battery-Powered Electric Sprayer
OWNER'S MANUAL



Distributed by:
Northern Tool & Equipment Company, Inc.
Burnsville, Minnesota 55306
www.northerntool.com

Made in China