

# Multi-Safe Safety Barricade Manual

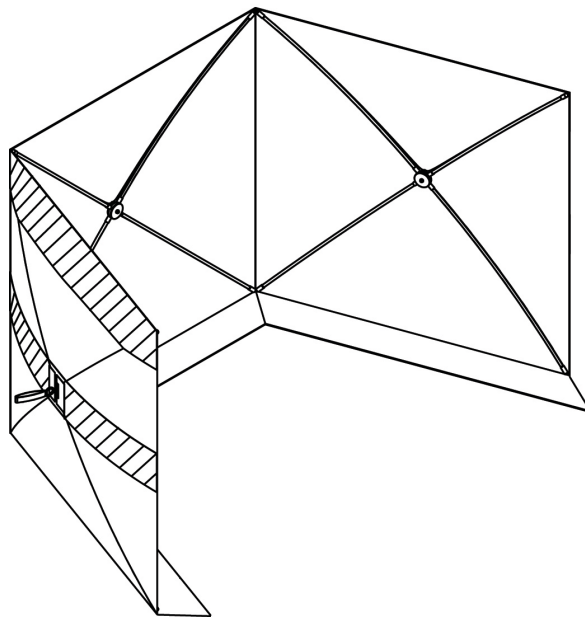

## WARNING

READ AND UNDERSTAND THE SET-UP MANUAL COMPLETELY BEFORE USING THIS PRODUCT. ASSEMBLE, TEST AND USE ONLY IN ACCORDANCE WITH THE OWNER'S MANUAL INSTRUCTIONS.

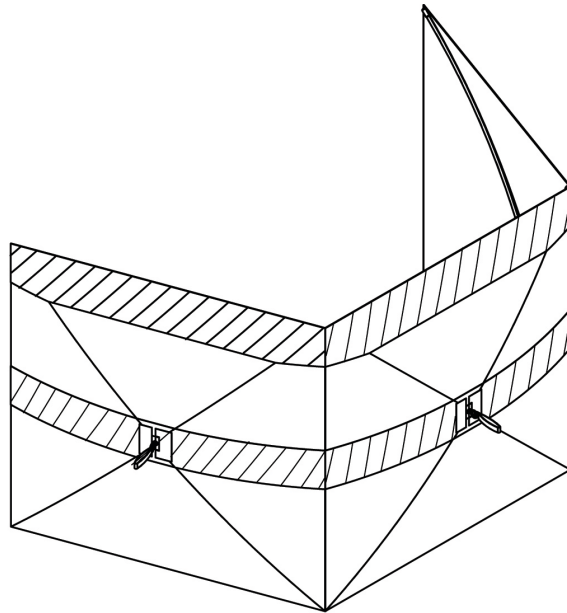

# 1 Introduction

Great Northern Equipment takes pride in this barricade and has designed it with quality materials and workmanship. This barricade is designed to help you efficiently and effectively provide a safer atmosphere at your job site, however it is not meant to be the only safety precaution used. GNE and dealers cannot be held responsible for any damage which may occur when using this product. It is the responsibility of the operator to create a safe working environment and assess the correct use and positioning as a part of their risk assessment.

## 1.1 Application

The safety Barricade is a light weight, portable way to separate the work area from bystanders, contain light flying debris and clearly define a work zone.

### Navigating This Manual

1. Use this manual to help familiarize yourself with safety, set-up, operation and warranty information. It is very important that you read this manual and follow the instructions to ensure safe operation of the barricade.
2. Please visit [www.gnedi.com](http://www.gnedi.com) for updated information.

## 1.2 Further Assistance



Your dealer and all of us at GNE want you to be pleased with your safety barricade. Should you require further assistance or have questions regarding your product, please contact your local dealer where you purchased your barricade, or please contact us at:



Great Northern Equipment  
 20195 South Diamond Lake Road, Suite 100  
 Rogers, MN 55374  
 800-822-0295  
[www.gnedi.com](http://www.gnedi.com)



# 2 Set-up



## 2.1 Unpacking Your Multi-Safe Barricade

Your Safety Barricade ships complete in 1 box. Carefully set the box on a flat working area. Carefully unbox the barricade and verify that no shipping damage has occurred.

	<h3>CAUTION</h3>	
	<p>IN WINDY CONDITIONS ANCHOR SAFETY BARRICADE USING A STAKE THROUGH EACH OF THE BOTTOM LOOPS INTO THE GROUND. ADDITIONAL WEIGHT MAY BE PLACED ON THE BOTTOM FLAP FOR ADDED ANCHORING.</p> <p>GET HELP FROM A SECOND PERSON SETTING UP IN WIND.</p>	

	<b>WARNING</b>	
	<p>KEEP AWAY FROM:</p> <ul style="list-style-type: none"> <li>• WELDING SPATTER</li> <li>• SPARKS</li> <li>• OPEN FLAME</li> <li>• HOT SURFACES</li> </ul>	

	<b>WARNING</b>	
	<p>AVOID ENTANGLEMENT IN SPINNING BLADES OR ANY OTHER POWER TOOLS.</p> <p>SAFETY BARRICADE IS NOT A STRUCTURAL BARRIER. DO NOT USE AROUND OPEN MANHOLES OR WHERE A FALLING HAZARD IS PRESENT</p>	

	<b>WARNING</b>	
	<p>CANCER AND REPRODUCTIVE HARM – <a href="http://WWW.P65WARNINGS.CA.GOV">WWW.P65WARNINGS.CA.GOV</a>.</p>	

## 2.2 Set-up

Remove Barricade from the carry bag. Unfold on a flat surface and untwist any material overlapping. Grasp the web loop in the center of the first panel. Support the top of the panel with the one hand and the bottom of the panel with your foot. Pull outward until the joint pops to the open position. Repeat with the remaining two panels.

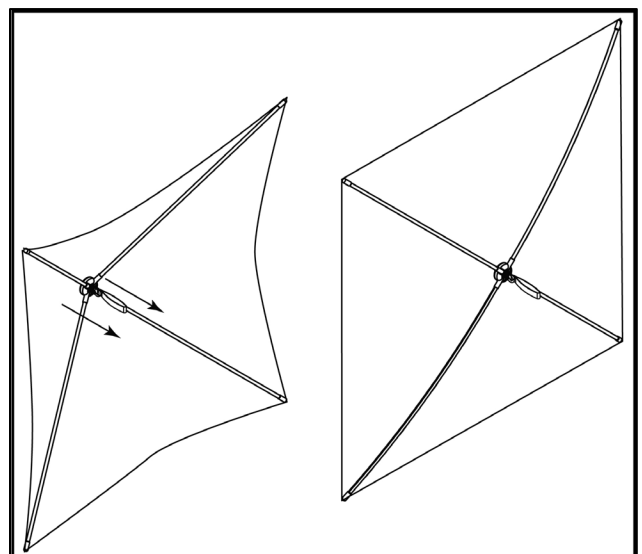
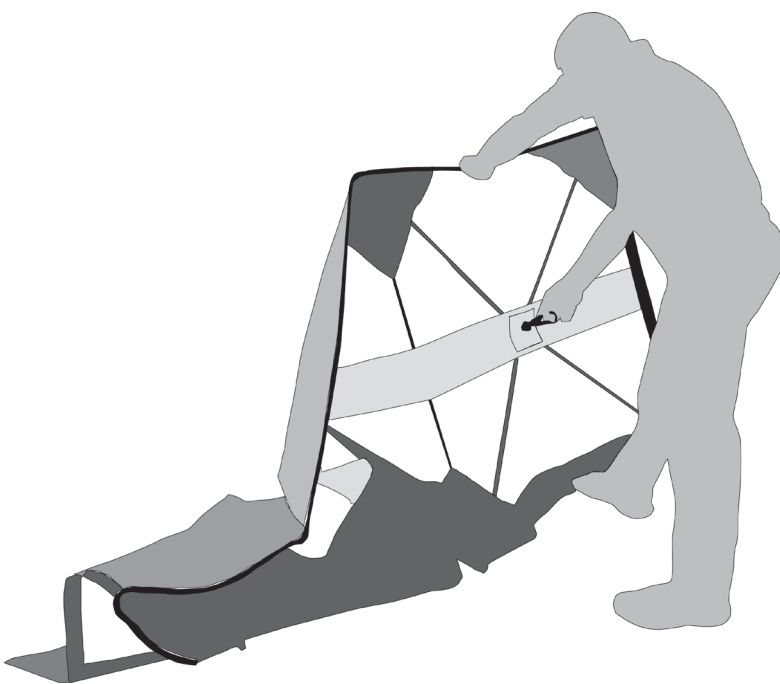

## 2.2 Join Multiple Barricades Together

Barricades can easily be joined together using the VELCRO flaps and loop strips on each edge of the unit. Join two or more units to define a large work area.

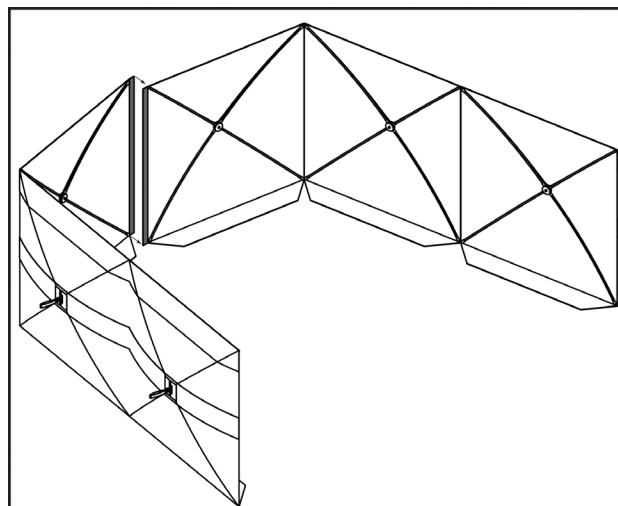

## 2.3 Take-Down Instructions

Support the top of the panel with the one hand and the bottom of the panel with your foot. Grasp the center joint of the first panel, and push inward from the outside, or pull inward from the inside. Carefully fold and lay the panel down moving over to the next panel. Repeat for all remaining panels.

Fold the barricade and neatly place in the carrying bag.

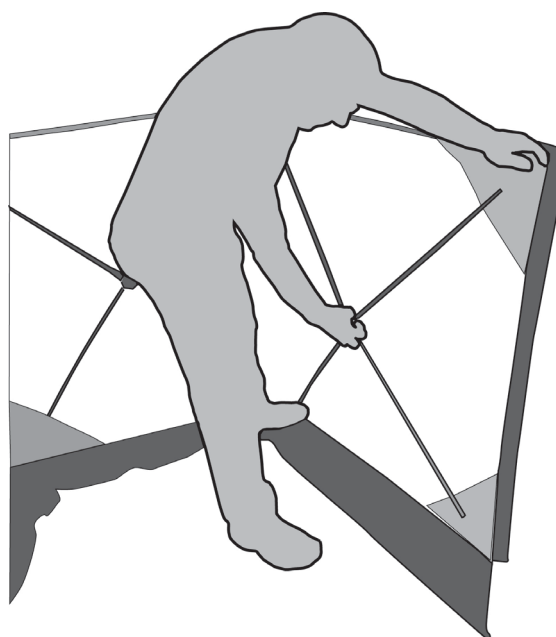

## 3 Storage Instructions

Store the Safety Barricade indoors, in a cool, dry place.

## 4 Specifications

- Dimensions: 3 panels - 41" W X 46" H Total length 123"
- Weight: 10 lbs.
- Includes carrying case
- Includes 4 ground stakes

## 5 Limited Warranty

GNE warrants that the Multi-Safe Barricade to be free from manufacturing defects for a period of 90 days from the invoice date. Should your product show signs of defective workmanship or material, prior to the expiration of the 90-day warranty, you should call our customer service department at 1-800-822-0295 to discuss options to exchange or return the product. This warranty is limited to the replacement of the product by GNE, and all shipping and return costs shall be at customer expense. This warranty does not extend to any defect or problem caused by the negligence or acts of you or others, failure to maintain the product in accordance with instructions furnished with the product, unreasonable use, accidents, alterations, or ordinary wear and tear. GNE is not responsible or liable for indirect and consequential damages of any kind, including but not limited to the use of any product, loss of time, inconvenience, or other incidental or consequential damages with respect to persons, business or property, whether because of breach of warranty, negligence or otherwise.