

# Operators Manual

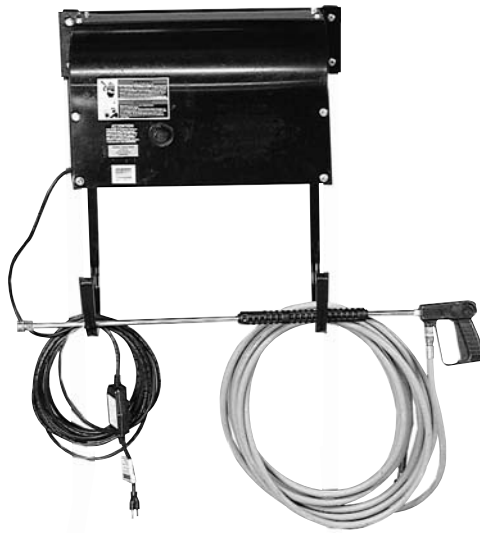

Model	PSI	GPM	HP
1000WM	1000	2.2	1.5
1500WM	1500	3.0	3
1000WM/SS	1000	2.2	1.5
1500WM/SS	1500	3.0	3
2000WM/SS	2000	4.0	5
2000WM/SSM3	2000	4.0	5
3000WM/SS	3000	4.0	7.5
3000WM/SSM3	3000	4.0	7.5

## Thank you

---

Thank you for selecting our products. Our personnel have proudly made every effort to ensure that your new pressure washer is of the quality you expect. But things do occasionally go wrong. This is why every pressure washer is covered by a limited warranty. Among other things, this warranty provides for the replacement of parts found to be defective during the operation of your new pressure washer. Please note that the owner/operator has certain obligations under the terms of the warranty. Be sure to read this manual for directions on proper installation, start-up, use, and storage of your pressure washer.

Your new pressure washer was tested after production for proper pressure and flow. Please note that this process will sometimes leave a water residue in the pump. The dealer you have purchased your new machine from should review with you the proper installation, start-up, use, and storage. Most 'big' problems occur when shortcuts are taken in one of these processes. If a problem occurs that you need some assistance with, please feel free to contact us at the listing below:

Warranty Service Center  
520 Brooks Road  
Iowa Falls, IA 50126  
1.800.648.6007

Please make note of Model Identification

Model # \_\_\_\_\_

Code # \_\_\_\_\_

Serial # \_\_\_\_\_

Always have this information when calling  
Warranty Service Center.

Be familiar with the model plate located on your machine. Have the model and code number with you when you call for service. **(Located on motor).**

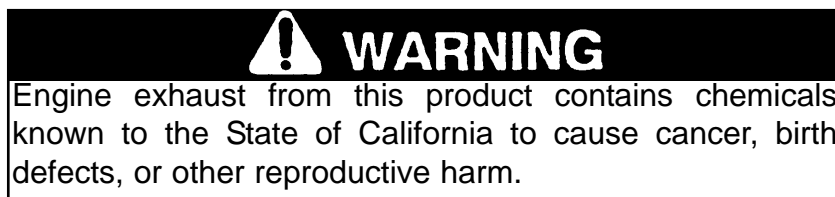
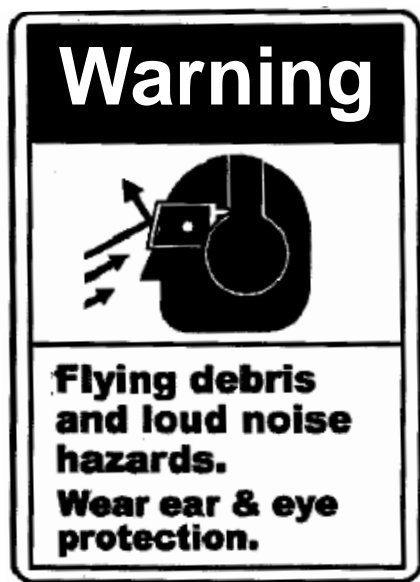

## Statement of Warranty

The manufacturer of this product agrees to repair or replace designated parts that prove defective within the warranty period listed in the chart below. Specific limitations and exclusions apply. This warranty covers defects in material and workmanship and not failure due to normal wear, depreciation, abuse, accidental damage, negligence, improper use, maintenance or storage. To make claim under the terms of the warranty, all parts said to be defective must be returned to a designated Warranty Service Center for warranty inspection. The judgments and decisions of the factory-authorized personnel concerning the validity of warranty claims are final.

Many components are covered by warranties given by their respective manufacturers. These warranties pass through to the end user. As a factory authorized and trained warranty service center the factory will honor the terms of all component warranties and satisfy claims of the appropriate warranty provisions.

Normal wear items include but are not limited to: hoses, nozzles, filter, valves, seals and are not covered by this warranty.

This warranty is in lieu of all other warranties, express or implied, including without limitation any warranties of merchantability or fitness for a particular purpose and all such warranties are hereby disclaimed and excluded by the Manufacturer. The Manufacturer's warranty obligation is limited to repair and replacement of defective products as provided herein and the Manufacturer shall not be liable for any further loss, damages or expenses, including damages from shipping, accident, abuse, acts of God, misuse or neglect. Neither is damage from repairs using parts not purchased from the Manufacturer or alterations performed by non-factory authorized personnel. Failure to install and operate equipment according to the guidelines put forth in the instruction manual shall void warranty.

Manufacturer	Warranty Period and Details
AR Pump	2 year 1 year on Pump/Motor units 1 year axial
Cat Pump	5 year on 2SF and 4SF models
	2 year on 5DX models 1 year axial
General Pump	5 year on pumps
	Lifetime on brass manifold against freezing
	1 year on Pump/Motor units
	1 year on the aluminum manifold
	1 year axial
Udor Pumps	5 year 1 year axial
Briggs and Stratton	1 year on standard engines
	2 year on Intek and Vanguard products
Hatz Diesel Engines	1 year
Honda Engines	3 year on GX series Engines effective 1/1/09
	2 year on GC products for personal use
	90 days on GC products in commercial use
Robin Engines	2 year
Baldor Electric Motors	1 year from date of purchase
Leeson Electric Motors	1 year from date of purchase
Burners	1 Year from date of purchase
Hot Water Coils	Lifetime of the machine
Machine Frame	1 year from date of purchase
Accessories: Includes tips, guns, wands, hoses, injectors, unloaders, gauges, switches, thermostats, sandblasters, flat surface cleaners, hose reels, turbo nozzles, drain nozzles, brushes, foamers, GFCI units, thermal relief, filters, tanks, etc.	90 days

Accessories: Includes tips, guns, wands, hoses, injectors, unloaders, sandblasters, flat surface cleaners, hose reels, turbo nozzles, drain nozzles, brushes, foamers, GFCI units, thermal relief, filters, tanks, etc. 90 days



# WARNING

***The following warnings must be followed, Failure to follow these warnings could result in serious personal injury or death!***

**Never allow children or untrained personnel to operate machinery.**



Electrical equipment can cause shock and sparks.  
Do not bypass or remove the grounding prong in any electrical plug.  
Keep electrical plugs, connections and cords out of water and moisture.  
Refer to instructions prior to equipment operation.  
Disconnect from power source before servicing.  
Inspect and repair damaged or exposed electrical components prior to use.  
Never splice electrical cords on pressure washers.



High Temperature Water.  
Wear protective clothing and face shield.  
Do not direct water stream toward self or others.  
Do not spray electrical apparatus.

**High pressure water can cause death or serious injury.**

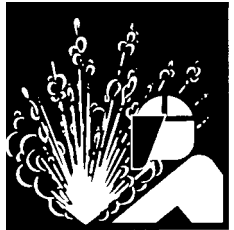

High pressure fluid can create a high pressure stream or ruptured vessel.  
Wear safety face shield.  
Relieve pressure before servicing.  
Do not modify/repair/rework vessel or change safety relief or pressure setting.  
Do not direct stream toward self or others.  
**Pressurized fluid streams and ruptured pressure vessels can cause death or serious injury.**

## Important Safety Instructions

**WARNING** - when using this product basic precautions should always be followed, including the following:

1. Read all the instructions before using the product.
2. To reduce the risk of injury, close supervision is necessary when a product is used near children.
3. Know how to stop the product and bleed pressure quickly. Be thoroughly familiar with the controls.
4. Stay alert - watch what you are doing.
5. Do not operate the product when fatigued or under the influence of alcohol or drugs.
6. Keep operating area clear of all persons.
7. Do not overreach or stand on unstable support. Keep good footing and balance at all times.
8. Follow the maintenance instructions specified in the manual.
9. "WARNING - Risk of Injection or Injury - Do Not Direct Discharge Stream At Persons."

## SAVE THESE INSTRUCTIONS GROUNDING INSTRUCTIONS

This product must be grounded. If it should malfunction or breakdown, grounding provides a path of least resistance for electric current to reduce the risk of electric shock. This product is equipped with a cord having an equipment-grounding conductor and a grounding plug. The plug must be plugged into appropriate outlet that is properly installed and grounded in accordance with all local codes and ordinances.

**DANGER** - Improper connection of the equipment-grounding conductor can result in a risk of electrocution. Check with a qualified electrician or service personnel if you are in doubts to whether the outlet is properly grounded. Do not modify the plug provided with the product - if it will not fit the outlet, have a proper outlet installed by a qualified electrician. Do not use any type of adapter with this product.

## Initial setup and operation of your new pressure washer

---

<b>Inspection for freight damage.</b>	When you receive your pressure washer be sure you check for concealed freight damage. Any damage should be noted with the delivering carrier. If you have any questions related to freight call the 800 number listed in the front of the manual.
<b>Inspection of oil levels</b>	Check all oil levels in the pump or engine if applicable. Failure to check all levels will result in equipment damage. Most pump are shipped with oil from factory and the crankcase are sealed, you may have to remove a shipping plug and install a dipstick in the pump. Oil type is stated on the pump breakdown and in the engine book.
<b>Water Supply</b>	Your water supply must provide water to the equipment that exceeds the Gallon Per Minute {GPM} rate of your machine. You can check your GPM by using a 5 Gallon bucket and a timer. If your machine is 5 GPM or less and the bucket fills in less than a minute you have adequate supply. Some systems are effected by things like washing machines, livestock watering systems and flushing of toilets. Be sure the supply is still adequate when these operations are taking place. The water temperature cannot exceed 145 Degrees Fahrenheit on the standard models and 180 degrees Fahrenheit on the high temperature models and the pressure should not exceed 60 PSI. <b>Failure to secure adequate water supply will result in pump damage. DO NOT RUN PUMP DRY.</b>
<b>Water Quality</b>	Your water should not contain particles larger than 80 microns. Although there are small filters installed on pressure washers that filter the water, they could only filter poor quality water for a short period of time before they clog. This would result in damage to the machine. Therefore you should insure no sand or scale particles are present in the water supply.
<b>Supply hose</b>	Hook a garden hose from the hydrant to the machine, when doing this be sure to check the inlet water filter or screen. This hose should be at least 5/8" diameter and a length at least 15 feet. This 15' length helps isolate the water supply from pulsations from the pump. <b>Many states require a Vacuum Break or backflow preventor be installed at the hydrant, before the garden hose, to insure the water source cannot be contaminated. Be sure to check local and state regulations upon installation.</b>
<b>Purge Air</b>	Turn on the water supply and open the trigger gun, this will purge all the air from the system. Look for water leaks and stop any leak found. Leaks can cause erratic pump behavior.
<b>Electrical Supply</b>	A circuit dedicated only to the pressure washer is recommended. This circuit should be installed by a licensed electrician and checked to supply adequate voltage <b>Under Load</b> . Sometimes the distance from the panel is to long, the wire size is to small or the voltage is initially to low, this will cause the GFCI or Thermal to trip. If the GFCI trips or the thermal overload on the motor trips consult factory. Plug your cord into the receptacle. <b>DO NOT USE EXTENSION CORD!</b>
<b>Pump</b>	Prior to turning on the power switches or your engine check the oil level in the pump.
<b>Turn on Power</b>	Turn on the power switch. Pull trigger gun and check for adequate pressure.

**During Operation**

The pressure was set at the factory during the testing procedure, no adjustments to the machine should be required for operation. **During operation do not leave the machine running for more than 2 minutes without the trigger gun being pulled. Although your machine has a by-pass valve on it and may have a thermal relief system, this can cause extensive pump damage. If machine will not be discharging water for more than 2 minutes, shut the machine off.**

**Nozzles**

Your machine is supplied with interchangeable spray tips. The black tip lowers your pressure and draws chemical. The other tips are for high pressure rinse at different spray angles. Red is 0 degree, yellow is 15 degree, green is 25 degree and white is 40 degree. The yellow tip is used for most standard applications. Be sure the quick coupler is fully engaged before pulling the trigger gun. Failure to do may result in the tip becoming a projectile and may be lost or damage to property or persons may occur.

**Chemical injector use**

Your pressure washer is supplied with a downstream chemical injector with dual chemical selector. The 1/4" clear vinyl tube is to be inserted into the desired chemical to apply. Be sure to use the black, low pressure nozzle to inject chemical. The chemical injector will only open up and allow chemical into the line when this tip is used. This tip enables the pressure to drop to approximately 250 PSI to draw chemical. The injector can be turned on and off or the rate of injection can also be set by turning the knob that the clear vinyl tube attaches to. See calibration below.  
**Be sure to flush injection system with clear water after use.**

**Calibration**

The chart below is an average ratio observed using water as the test fluid to draw through the injector and serves only as a guide, your actual ratio will vary.

Setting on valve	Injection Ratio
9	6:1
8	8:1
7	10:1
6	13:1
5	20:1
4	28:1
3	35:1
2	50:1

For better accuracy, calibrate using the following formula:

$(\text{GPM} \times 128) \div (\text{ounces drawn in 1 minute}) = x:1$ .

IE: If a 2.0 GPM machine draws 8 ounces of chemical in 1 minute:  $\frac{(2 \times 128)}{8} = 32:1$

**Hoses and couplers**

Factory supplied hoses are sized in length and diameter for best operational performance and sized within the pressure capabilities. Additional hose added to the machine may change the performance of the machine. Consult factory if you have any questions. When replacing or disconnecting the quick couplers be sure the machine is shut off and relieve the pressure from all hoses.

---

## Shut down procedure

---

- Storage**
1. Turn off the power switch on the pressure washer.
  2. Relieve pressure on line by pulling trigger gun.
  3. Shut off water supply and disconnect garden hose.
  4. Be sure to check for water leaks or oil leaks that should be repaired before the next operation.
  5. If you are going to store the machine for extended period of times in cold climates be sure to anti-freeze the equipment. A 50% anti-freeze solution may be drawn in through the inlet of the pump using a short remnant of garden hose. This fluid should be run through the pump when the fluid is discharged from the pump discharge your machine is winterized. **Do not allow machine to freeze.**
- Pump** The pump oil should be checked before each use. Oil should be changed after the first 50 hours then twice a year, or every 250 hours.
- Filters** Water filters, hoses and fittings should be checked prior to every operation for cleanliness, leaks and repair needs. Repair or replace as needed.

---

## Troubleshooting - Common Problems and Solutions

---

- Low Nozzle Pressure** Low nozzle pressure is a common complaint. In a majority of instances, low nozzle pressure is generally caused by one of the following:
1. Plugged nozzle tip.
  2. Inlet screen plugged.
  3. Insufficient flow in gallons per minute (not pressure) to the pump.
  4. Unloader valve stuck open due to debris lodged under the check valve ball.
  5. Customer use of shut-off-type quick connectors.
  6. Plugged hose.
  7. Incorrect nozzle or soap tip installed.

- Surging Operation** Another complaint is that pressure *surges*. That is, when the trigger is pulled, pressure is satisfactory for a moment then falls off. When the trigger is released, pressure builds up to normal levels. This is generally a sign that the water supply cannot provide the flow rate (gallons per minute) required by the pump. Following are some possible solutions:
1. Make sure the supply is not restricted; that there are no under-sized fittings and the inlet screen is unobstructed.
  2. Make sure the flow rate of the water supply is sufficient for the pump. First, find the capacity of your pump in gallons per minute (gpm) as shown in the *Water Supply section on Page 5*. Then determine the flow rate of your supply by measuring the gallons that can be delivered in one minute. If your supply does not deliver the gpm your pump requires, do *not* use the pump. It will suck air, causing cavitation that can quickly damage pump components.
  3. Check for leaks in the supply fittings. Any leak will cause the pump to draw air and perform poorly.

- Soap Injector Not Working Properly** When a soap injector is not working properly, the problem is generally fairly easy to isolate. Check the following:
1. Make sure the Black, soap tip is installed. Soap injectors will *not* work when high pressure nozzles are installed.
  2. Be sure that the soap injector valve is turned on, and turn selector valve to desired setting.
  3. A piece of debris may be caught in the injector valve, injector ball valve, or orifice. Disassemble and clean the injector.

- Notice** User maintenance procedures include replacing valves and seal. Unloader components are **not** user serviceable. Repairs involving unloaders and crankcase components should be referred to the factory or a factory authorized repair center.

# Mounting plate

Wall Mount Bracket

All Steel is  $\frac{1}{8}$ " thick

Units: Inches

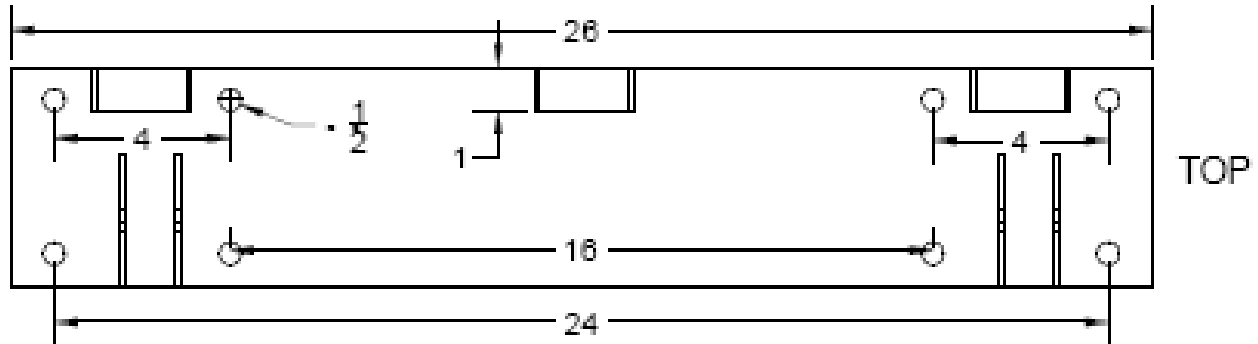

To fasten to a block wall use four  $\frac{3}{8}$ " x  $2\frac{1}{2}$ " sleeve anchor bolts

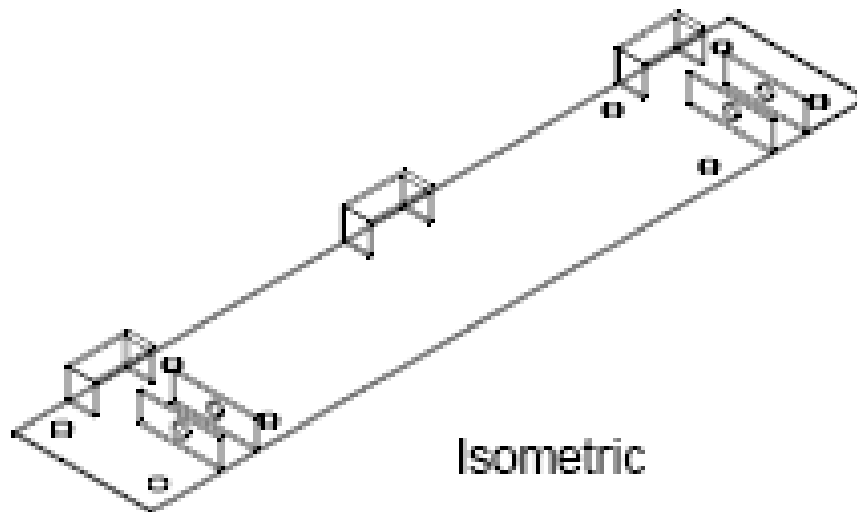

# Wall mount Gun Wand Assemblies

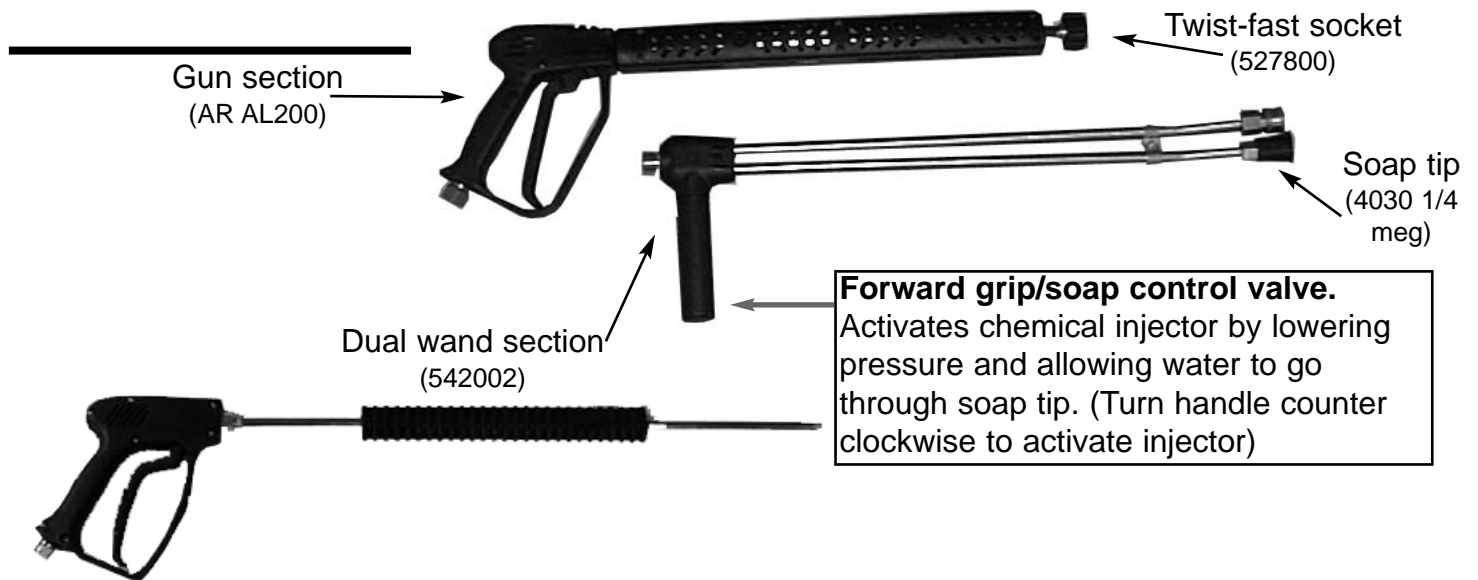

Part Number	Description
510065	1/4" Quick Coupler for small wall mount units
510100	O-Ring for 1/4" Quick Coupler for small wall mount units
509372	Small Wall Mount Gun
509370	Small Wall Mount Lance
AR AL200	Large Wall Mount Gun section of wand
542002	Large Wall Mount Dual wand section

## Replacement Quick Tips For All Units

Flow	2.2 GPM	3.0 GPM	4.0 GPM	4.0 GPM
Tip Description	Model 1000WM	Model 1500WM	Model 2000WM/SS	Model 3000WM/SS
<b>Black-Soap Tip</b>	509520	509520	509520	509520
<b>Red-0 Degree</b>	0004 Q Meg	0005 Q Meg	0006 Q Meg	0004 Q Meg
<b>Yellow-15 Degree</b>	1504 Q Meg	1505 Q Meg	1506 Q Meg	1504 Q Meg
<b>Green-25 Degree</b>	2504 Q Meg	2505 Q Meg	2506 Q Meg	2504 Q Meg
<b>White-40 Degree</b>	4004 Q Meg	4005 Q Meg	4006 Q Meg	4004 Q Meg