

BRAVE

OPERATOR'S MANUAL

Safety, Operation & Service Information

200 Series Two-Man Augers

Model: BRPA265H/BRPA270H

Form: GOM08042004US, Version 1.0, Original Instructions

- Do not discard this manual.
- Keep manual readily available for reference during operation or when servicing product.
- Before operation, read and comprehend operator manual content.
- When ordering replacement parts, please supply the following information: model number, serial number and part number.
- **Customer Service:** 1-800-359-8739
- **Customer Service Telefax:** 1-866-779-9963
Note: There is no charge for Customer Service.
- **Internet Address:** <http://www.braveproducts.com>
- **Email:** sales@braveproducts.com

Copyright 2020, Brave, All rights reserved.

TABLE OF CONTENTS

1 INTRODUCTION 3
 2 INTENDED USE 3
 3 TRAINING 3
 4 SAFETY SYMBOLS 3
 5 SAFETY INSTRUCTIONS 3
 6 MACHINE SPECIFICATIONS 6
 7 STANDARD PRODUCTS & ACCESSORIES 6
 8 MACHINE SET-UP 7
 9 APPLICATION THEORY & TECHNIQUES 10
 10 OPERATING INSTRUCTIONS 11
 11 MAINTENANCE INSTRUCTIONS 15
 12 SERVICE/REPAIR INSTRUCTIONS 18
 13 TROUBLESHOOTING 23
 14 STORAGE 23
 15 END OF LIFECYCLE 24
 16 WARRANTY 25
 17 PRODUCT REGISTRATION 26
 17 REPLACEMENT PARTS 28

- It is responsibility of owner(s) and/or operator(s) to determine no modifications and/or alterations have been made to Auger. Modifications and/or alterations can lead to possibility of serious damage, injury or even death. It is responsibility of owner(s) and/or operator(s) to make this Operator Manual available for consultation during all phases of operation.
- Refer to OSHA 2207 and/or applicable updated revisions which contains all OSHA job safety, health rules and regulations (1926 and 1910) covering construction.

CAUTION

The concept of portable, one and two man operated, hole digging equipment has been successfully utilized for over forty years as a practical solution to many types of hole digging job requirements. The basic concept is proven and well accepted within the associated marketplaces as an alternative method to manual labor and/or larger, mounted earth drilling machinery.

Use of an Auger requires strenuous work activity. This type of work activity can be considered to be greater in magnitude than that experienced with the use of many other types of both light construction and lawn and garden related equipment. This type of work activity should only be attempted by operators of adequate physical size and stature, mental awareness, and physical strength and condition.

Each operator is required to supply a resultant force that counteracts/balances and/or resists the natural torque and kickback forces generated during the hole digging process. The body parts most noticeably affected during the hole digging process are the arms, hands, wrists, shoulders, lower back and legs. The hole digging process can also produce excessive stress/strain directly to the back muscles, spinal vertebrae and many other body parts. Back related pain can be a side effect of the hole digging process. An operator with a chronic back related problem or a history of back and/or other medically related problems should not attempt to utilize the Auger. Use of the Auger may only aggravate this and any other medically related problem.

The torque and kickback forces generated and/or encountered correspond to natural laws of physics and are inherent to the hole digging process. They cannot be changed or totally eliminated with portable one and two man operated, hole digging equipment of this design. Proper operating positions and techniques, as outlined in this manual, can be successfully utilized to minimize the effects of the torque and kickback forces upon the human body.

Because of the diverse type of prevailing digging conditions, operator experience levels and operator physical characteristics, no warranty, guarantee, representation and/or liability is made by the manufacturer as to the absolute correctness or sufficiency of any operational procedure, operational position and/or technique. There is no absolute guarantee that an operator of any given experience level, physical size and/or physical condition will be immune to the possibility of and/or probable physical side effects of the normal hole digging process.

Each potential operator of the Auger must be made aware of and assume the operational and physical liability described and/or associated with the hole digging process when utilizing the Auger. **Each potential operator not willing to assume the operational and physical liability described and/or associated with the hole digging process should not operate the Auger.** Proper levels of operator experience, skill and common sense are essential for maximizing the safe and efficient operation of the Auger.

Record Auger and engine/electric motor serial numbers in spaces provided below.

Model Number: _____

Serial Number: _____

Engine/Electric Motor Serial Number: _____

Date of Purchase: _____

Specifications and design are subject to change without notice or obligation. All specifications are general in nature and are not intended for specific application purposes. Brave reserves the right to make changes in design, engineering or specifications and to add improvements or discontinue manufacture at any time without notice or obligation. Brave and its agents accept no responsibility for variations which may be evident in actual products, specifications, pictures and descriptions contained in this publication.

NOTICE TO OPERATORS

IF YOU CAN NOT READ OR DO NOT FULLY UNDERSTAND THE CONTENTS OF THIS MANUAL, PLEASE CONTACT THE FACTORY FOR PROPER ASSISTANCE BEFORE ATTEMPTING TO OPERATE THIS PRODUCT.

SI TU NO PUEDES LE'ER O NO COMPRENDES EL CONTENIDO DE ESTE MANUAL FAVOR DE PONERSE EN CONTACTO CON LA FABRICA PARA ASISTENCIA-APROPIA ANTES DE INTENTAR PARA OPERAR ESTE PRODUCTO.

SOLLTEN SIE DIESE GEBRAUCHSANWEISUNG NICHT LESEN KOENNEN ODER ES NICHT VOLLKOMMEN VERSTEHEN, WENDEN SIE SICH BITTE AN DEN HERSTELLER FUER RICHTIGE HILFE EHE SIE VERSUCHEN DIESES PRODUKT ZU OPERIEREN.

SI VOUS NE LISEZ OU NE COMPRENDRE ENTIEREMENT LES MATIERES DE CE MANUEL, S'IL VOUS PLAIT, CONTACTEZ L'USINE POUR L'ASSISTANCE APPROPRIEE AVANT D'UTILISER LE PRODUIT.

IMPORTANT:

- DO NOT allow anyone to operate Auger without first reading this Operator Manual and becoming familiar with Auger operation.
- Manufacturer of this Auger has gone to great extremes to provide owner(s) and/or operator(s) with the finest equipment available for its intended job function of digging vertical holes in unconsolidated and specific semi-consolidated earth formations. Yet, the possibility exists Auger can be utilized in and/or subjected to job applications not perceived and/or anticipated by manufacturer. Such misuse and/or misapplication of Auger can lead to possibility of serious damage, injury or even death.
- It is responsibility of owner(s) and/or operator(s) to determine Auger is utilized and/or operated within scope of its intended job function.
- It is responsibility of owner(s) and/or operator(s) to establish, monitor and constantly upgrade all safety programs and/or practices utilized in and for operation of Auger. Purpose of such programs is to provide for owner(s') and/or operator(s') safety. Operators must be instructed to recognize and avoid unsafe conditions associated with their work (29 CFR 1926.21 (b)(2)) and/or applicable updated revisions.

OPERATOR INSTRUCTIONAL DATA SHEET

The following undersigned operators of Auger described and/or pertaining to this Operator Manual have received formal safety and operational information/instruction from undersigned owner(s)/instructor(s) in accordance to OSHA 29 CFR 1926.21 (b)(2) and/or applicable updated revisions pertaining to, but not necessarily limited to the:

- 1. READING, COMPREHENSION AND ACKNOWLEDGEMENT OF MATERIAL COMPRISING ENTIRE CONTENTS OF APPLICABLE OPERATOR MANUAL.
- 2. FORMALIZED OPERATOR SAFETY PROGRAM TO BE DEvised BY OWNER OF AUGER IN CONJUNCTION WITH CONTENTS OF APPLICABLE OPERATOR MANUAL FOR AUGER.
- 3. OSHA RULES AND REGULATIONS RESEARCHED FOR AND/OR BY OWNER OF AUGER AND DEEMED APPLICABLE TO SAFE AND PROPER USE AND/OR OPERATION OF AUGER FOR ANY SPECIFIC JOB APPLICATION.
- 4. LOCAL LAWS, REGULATIONS AND CUSTOMS RESEARCHED FOR AND/OR BY OWNER OF AUGER AND DEEMED APPLICABLE TO SAFE AND PROPER USE AND/OR OPERATION OF AUGER FOR ANY SPECIFIC JOB APPLICATION.
- 5. FORMALIZED MAINTENANCE PROGRAM FOR AUGER TO BE DEvised BY OWNER OF AUGER IN ACCORDANCE WITH, BUT NOT NECESSARILY LIMITED TO, SPECIFICATIONS, GUIDELINES AND OPERATIONAL INFORMATION CONTAINED IN APPLICABLE OPERATOR MANUAL.
- 6. COMPREHENSIVE OPERATIONAL INSTRUCTIONS FOR CORRECT AND PROPER USE OF AUGER AS PER CONTENTS OF APPLICABLE OPERATOR MANUAL.

_____	Operator	_____	Owner/Instructor	_____	Date
_____	Operator	_____	Owner/Instructor	_____	Date
_____	Operator	_____	Owner/Instructor	_____	Date
_____	Operator	_____	Owner/Instructor	_____	Date
_____	Operator	_____	Owner/Instructor	_____	Date
_____	Operator	_____	Owner/Instructor	_____	Date
_____	Operator	_____	Owner/Instructor	_____	Date
_____	Operator	_____	Owner/Instructor	_____	Date
_____	Operator	_____	Owner/Instructor	_____	Date
_____	Operator	_____	Owner/Instructor	_____	Date
_____	Operator	_____	Owner/Instructor	_____	Date
_____	Operator	_____	Owner/Instructor	_____	Date
_____	Operator	_____	Owner/Instructor	_____	Date
_____	Operator	_____	Owner/Instructor	_____	Date
_____	Operator	_____	Owner/Instructor	_____	Date
_____	Operator	_____	Owner/Instructor	_____	Date
_____	Operator	_____	Owner/Instructor	_____	Date
_____	Operator	_____	Owner/Instructor	_____	Date

NOTE: INSERT COPIES OF THIS PAGE WITHIN OPERATOR'S MANUAL IF SPACE FOR ADDITIONAL OPERATORS IS REQUIRED.

1 INTRODUCTION

Congratulations on your decision to purchase a Brave light construction product. It has been a continuing objective of Brave to provide equipment that delivers uncompromising value, service life and investment return.

When you purchased this product, you also gained access to a team of dedicated, knowledgeable, support personnel that stand willing and ready to provide field support assistance. Our team of sales representatives and in-house personnel are available to ensure each Brave product delivers the intended performance and product safety you expect. Our personnel can readily answer your questions or concerns regarding proper applications, service requirements and warranty related problems.

If you have any questions or concerns about this product, please feel free to contact our Customer Service Department during normal business hours using the contact information located on the front cover of this manual. There is no charge for this service.

Sincerely,
The Brave Team

2 INTENDED USE

The Auger is intended for use in digging holes outdoors in a variety of soil conditions from soft loams to hard-packed caliche. The machine is operated by two adults of proper operator experience/skill/ common sense, height, weight, strength and physical condition. Minors should never be allowed to operate the Auger.

Auger is classified as a low cost, hand held, low horsepower, portable type machine. The number of practical and/or suitable job applications for this type equipment is limited. Particular job application variables and operator experience/skill/common sense may require a different type machine, method and/or process to properly complete job efficiently and safely. Contact Customer Service Department for specific information regarding suitable job applications, job sites, soil conditions and operator experience/skill/common sense recommendations for Auger BEFORE utilization.

Never exceed the recommended capacities of Auger. Refer to BEFORE OPERATING and SPECIFICATIONS sections in this manual for more detailed information. Always utilize correct auger bit and auger bit extension series designed for use with Auger. DO NOT use ice augers to dig earth. Use of an incorrect auger or auger bit series can result in property damage and/or personal injury.

OPERATIONAL DISCLAIMER

The manufacturer of this Auger makes no warranty or guarantee it is merchantable and/or suitable for a specific job application and that it will have the power required to dig a specific diameter hole down to a specific depth in a specific soil classification.

3 TRAINING

Develop a comprehensive program for safe Auger operation by owner(s) and/or operator(s). Program will include, but is not limited to: instructional operation requirements, applicable OSHA requirements, local laws and regulations, job site safety plus Auger maintenance. Constantly examine and upgrade program to guarantee owner(s) and/or operator(s) safety. Each operator must be fully instructed regarding specifics of this safety program.

4 SAFETY SYMBOLS

SAFETY ALERT SYMBOL & SIGNAL WORDS

The safety alert "general warning" symbol indicates a potential personal injury hazard. A signal word (DANGER, WARNING, or CAUTION) is used with the alert symbol to designate the degree or level of hazard seriousness. Other safety symbols may be used to represent the type of hazard in combination with "general warning" symbol, in highlighted boxes, or individually.

DANGER:

Indicates a hazard with a high level of risk which, if not voided, *will* result in death or serious injury.

WARNING:

Indicates a hazard with a medium level of risk which, if not avoided, *could* result in death or serious injury.

CAUTION:

Indicates a hazard with a low level of risk which, if not avoided, *could* result in minor or moderate injury.

The following safety alert symbols identify important safety messages in this manual. When you see these symbols, be alert to the possibility of personal injury and carefully read the message that follows.

SAFETY SYMBOLS & MEANINGS

Symbol	Meaning	Symbol	Meaning
	Action Required		General Warning
	Read Manual		Warning, Flammable Material
	Wear Ear Protection		Warning, Explosive Material
	Wear Eye Protection		Warning, Toxic Material
	Wear Protective Gloves		Warning, Electricity
	Wear Safety Shoes		Warning, Body Entrapment
	No Open Flame		Warning, Rotating Parts
	No Smoking		Warning, Hot Surface
	No Active Mobile Phone		Warning, Floor Level Obstacle
	No Food Or Drink		Warning, Drop Off
	No Trash Containers		Warning, Slippery Surface

5 SAFETY INSTRUCTIONS



WARNING

- These safety instructions provide guidelines to promote safety and efficiency with the Auger.
- No warranty, guarantee or representation is made by manufacturer as to absolute correctness or sufficiency of any information or statement.
- Safety instructions are intended to deal with common practices and conditions encountered in use of Auger and are not intended to be all inclusive.
- Not following instructions in this manual can result in property damage, personal injury and/or death.



DANGER



- This product can expose you to chemicals including greases, lubrication oils, silica dusts and asbestos which are known to the State of California to cause cancer and carbon monoxide (if gasoline engine driven) which is known to cause birth defects or other reproductive harm. For more information: www.P65Warnings.ca.gov

SPARK ARRESTER DISCLAIMER



WARNING

- **DO NOT operate Auger on any forest covered, brush covered, or grass covered, unimproved land unless an approved spark arrester is installed on the muffler. The spark arrester must be maintained in proper working order by the owner and/or operator. In the State of California, the above is required by law. Other states may have similar laws. Laws will apply on US Federal lands. Laws will vary with use in specific countries.**

BEFORE OPERATING



1. BEFORE operating the Auger, read this manual plus applicable safety/operational information supplied by engine manufacturer to familiarize each operator with correct operating procedures.
2. Visually inspect Auger per MAINTENANCE INSTRUCTIONS STEPS 4 through 15 of this manual.
3. Determine Auger is in original, factory configuration and has not been modified in any manner. If questions arise about possible modifications, contact the Customer Service Department BEFORE utilization. There is no charge for this service.
4. Always start and stop Auger according to instructions to minimize possibility of unexpected or uncontrolled auger rotation. Know how to stop unit in an emergency.

Physical Exertion/Body Strain

Operating the Auger requires proper physical stamina, mental alertness and is strenuous. Operators must be in proper physical condition, mental health and not under the influence of any substance (drugs, alcohol, etc.) which might impair vision, dexterity or judgement. Take work breaks to maintain stamina and alertness. If you have condition(s) that might be aggravated by strenuous work, check with doctor BEFORE operating.

Operator Crew Members

Operators must be of adequate height for any given operating configuration and operator handle(s) must remain below their shoulder sockets. DO NOT operate Auger if this condition is not satisfied. Augers require both operators be of similar height, weight and strength to maximize digging efficiency and minimize possibility of personal injury.

Vibration

Prolonged use of Auger (or other, similar machines) exposes operator to vibrations which may produce Whitefinger Disease (Raynaud's Phenomenon) reducing hand's ability to feel and regulate temperature, produce numbness and burning sensations plus may cause circulation damage and tissue necrosis. Continuous and regular users should closely monitor condition of hands and fingers. After each period of use, exercise to restore normal blood circulation. If any symptoms appear, seek medical advice immediately.

Noise

Auger and actual digging process creates exposure to high noise emission levels that can result in hearing loss or damage. Hearing protection is required while operating or when near operating equipment. Continuous and regular operators should have hearing checked regularly.

Poisonous Gas

Auger is powered by a gasoline engine which produces Carbon Monoxide fumes during combustion process. Carbon Monoxide fumes are poisonous. If Auger is operated in closed area (indoors or outdoors), determine if supplemental ventilation is required to minimize potential effects of Carbon Monoxide to operators. Follow all current OSHA regulations for ventilation.

Clothing

Clothing must be sturdy, snug fitting, but allow complete freedom of movement. Never wear loose fitting jackets, scarves, neckties, jewelry, flared or cuffed pants or anything that could become caught on controls or moving parts. Properly secure eyeglasses, hearing aid devices and other medical related devices. Wear long pants to protect legs. Protect hands and improve grip with heavy duty, nonslip gloves. Wear and properly lace sturdy boots with nonslip soles. Steel-toed safety shoes are mandatory. Wear approved safety hard hat where there is danger of head injuries.

Flying Debris

Hole digging process can result in flying debris. Eye protection and appropriate safety apparel is required when near or operating Auger. DO NOT operate unit with onlookers or animals close by.

Burns

An engine muffler can become hot. Remain clear of and DO NOT touch a hot muffler or heat shield.

Auger Entrapment

Auger bit is not shielded. Keep body and all foreign objects clear of rotating auger bit.

BACK CARE & PROPER LIFTING PROCEDURES

Operators will be required to lift Auger, auger bit/auger bit extension repetitively as demanded by specific job applications. When lifting, two people are required. Utilize proper lifting techniques to minimize fatigue and back-related injuries.

Back Anatomy

The human body is supported by the spinal column consisting of thirty bones called vertebrae, all linked and supported by a series of muscles. Pads called discs separate each vertebrae, acting as cushions to pressure from external forces. Spinal column is wrapped by nerve system with three sections that require being kept in natural alignment to prevent discomfort:

- Cervical: From base of neck to brain.
- Thoracic: From middle to lower back.
- Lumbar: From lower back to buttocks area.

Back Care Preventative Measures

Most occupational physicians agree on several "universal" preventative measures an operator should follow to help lower risk of back-related injuries:

1. Maintain proper body weight.
2. Eliminate/reduce use of tobacco. Smoking reduces oxygen supply and nutrients to discs cushioning vertebrae.
3. Develop a consistent exercise routine.
4. Maintain good posture while walking or sitting.
5. Watch how you twist/bend your body while digging to prevent. Twisting/bending incorrectly can exert too much pressure on discs and vertebrae.
6. Use firm footing, keep intended path clear before carrying Auger.
7. Always use proper lifting techniques as described below.

PROPER LIFTING PROCEDURES

The following are guidelines for properly lifting Auger and auger bit/auger bit extension from hole and are not intended to be all inclusive. Plan your path and make sure there are no obstructions or tripping hazards. Consider how you will set the load. The spinal column is a very sensitive mechanism. At any given time, improper lifting procedures can cause damage that can lead to injury.

1. Position feet a comfortable distance (shoulder width) apart to help provide necessary balance.
2. Tighten stomach muscles by pulling in your stomach. Keep back as straight as possible to keep spine, back muscles/ligaments in alignment.
3. Bend at hips and knees as much as possible.
4. Start lifting Auger by thrusting feet while lifting as much as possible with leg muscles. Use smooth movements.
5. Once Auger is lifted, keep it close as possible to the body. Avoid turning at waist. To turn, pivot entire body.
6. Keep shoulders, hips and feet pointed in same direction.
7. Use firm footing, keep intended path clear before carrying Auger.

TRANSPORTATION



1. Auger is designed for two operators to transport it by the operator handles to, while on, and from job site.
2. When transporting Auger in/on motor vehicle, gasoline tank breather vent (if so equipped) must be completely closed to eliminate fuel seepage.
3. To minimize damage to Auger, transport in vehicle to job site with auger disconnected and operator handles level with transport surface. This prevents transmission oil entrapment causing clutch drum slippage and/or draining from breather vent plus crankcase oil entering combustion chamber causing hydraulic lock up.
4. DO NOT allow operator handles to contact augers, shovels, or other sharp/abrasive objects during transit or drop Auger to prevent damage to unit.
5. All equipment must be secured in/on vehicles with suitable strapping or tie downs.
6. Personnel should not be transported in same compartment as equipment and fuel supplies. Consult applicable OSHA regulations for specific information.



CAUTION

- Improperly secured Hole Digger and related accessories can fall from moving vehicle and result in property damage and/or personal injury.

DETERMINATION OF POTENTIAL SUBSURFACE HAZARDS IN PROPOSED DIGGING LOCATION(S)



Auger operator handles, grips and throttle control are constructed of non-metallic, composite material and do not guarantee operators will be properly insulated from contact with charged electrical cables. Auger and related accessories are not classified as insulated.

Auger is not sealed or insulated. DO NOT operate Auger in an explosive atmosphere or near combustible materials. Refer to current OSHA rules and regulations.



WARNING



BEFORE attempting to dig any holes, identify/mark all potential subsurface hazards in proposed digging locations(s). Potential subsurface hazards may include, but may not be limited to the following:

1. Rocks and roots of any size.
2. Differences and/or variances in specific soil classifications.
3. Buried garbage/other debris.
4. Buried pressurized pipelines (e.g. natural gas, propane, etc.)
5. Buried electrical cables.



DANGER



- Always assume digging location contains buried underground obstructions.
- BEFORE attempting to dig any holes in proposed location(s), call 811 and/or visit www.Call811.com.
- Contact appropriate agencies to determine exact location(s) of all buried pipelines, powerlines and material debris.
- Many utilities and other agencies will perform these tasks at minimal charge or at no cost. Have all subsurface hazards marked for easy recognition.
- Direct contact with these and other subsurface hazards can result in property damage and/or personal injury through such things as electrocution and/or explosion.

DETERMINATION OF POTENTIAL ABOVE SURFACE HAZARDS IN PROPOSED DIGGING LOCATION(S)



Normal Auger use is on level ground. Avoid other terrains which can be dangerous. Special care must be exercised on overgrown, slippery, and/or difficult/uneven terrain. Watch for surface irregularities. Remove any trip/fall hazard, grass or other overgrowth BEFORE operating Auger. Operate only when/where visibility and light are adequate for job at hand. Keep proper footing and balance with good communication between Crew Chief and Crew Member at all times. Engine/engine muffler can become extremely hot with potential to burn operators and/or ignite dried materials such as leaves, grass, etc. Remove such materials where digging with or placing Auger.

**OPERATIONAL HAZARDS
UNDERSTANDING KICKBACK**



Torque and kickback generated by digging process is common with portable, two-man hole diggers. Auger engine torque is transmitted and multiplied by transmission to auger bit. When auger bit contacts a buried obstruction, left side operator handles are "thrust" towards operators in a sharp, sudden, counter-clockwise rotation. "Thrusting" force is called kickback and varies depending on speed of handle movement. Kickback force can have magnitude to "throw" operators from Auger and/or inflict damage to hands, arms, and other upper body parts.

Preventive Measures:

- Operators must maintain physical and mental alertness. Be prepared for unexpected auger contact with buried tree roots, rocks, etc., and be capable to sense level of machine control they have.
- Maintaining proper operating stances and applying reactive "body english" is one of the most IMPORTANT and EFFECTIVE procedures to control kickback. Refer to OPERATOR STANCES in OPERATING INSTRUCTIONS section of this manual for more information.
- "Spinning" about axis is caused by improper engine throttle control adjustment. Refer to INSTALLING OPERATOR HANDLES in MACHINE SET-UP section of this manual to correct situation BEFORE placing machine back into service.



CAUTION

- Always assume every digging site can include some form of buried obstruction. Always be prepared for unexpected auger bit contact with buried tree roots, rocks, etc.
- Under certain operating conditions, striking a buried obstruction can produce a severe and/or sudden kickback force to hip and/or leg areas.
- Force can have magnitude to "throw" operators from Auger.
- Failure to properly accommodate this phenomenon can result in property damage and/or personal injury.



WARNING



If, during hole digging process, operators lose full control of Auger for any reason, the following procedure is suggested:

- As a general rule, as soon as operators realize they are in process of losing control of Auger, they should "push" themselves free and clear from operator handles.
- Procedure requires operators fully comprehend they are losing control of Auger and to react accordingly with appropriate body movement.
- Improper reactions to this phenomenon can result in property damage and/or personal injury.

WARNING

- An Auger with improperly maintained engine throttle control will “spin” about its axis when operators lose full control.
- In event of this occurrence, do not attempt to stop engine by grasping rotating operator handles.
- DO NOT introduce any foreign object in an attempt to stop and/or block rotating handles. Instead, allow engine to exhaust its fuel supply.
- Determine that all components of engine throttle control assembly allow for proper function before attempting to further utilize Auger.

MINIMIZING KICKBACK FROM A DESIGN STANDPOINT

1. Auger features the longest operator handles of any machine of its type and/or class. Handles are biomechanically positioned to enhance control, allowing operators to exert “body english” against torque and kickback forces generated by digging process.
2. Auger features operator handles constructed of non-metallic, composite material. Material physical characteristics dampen torque and kickback experienced by operators during digging process.
3. Auger utilizes a twist grip throttle control. Throttle control was selected over other configurations (for operator handle configuration utilized and specific digging power) to allow operator to wrap his/her thumb and forefinger around for effective maximum strength in his/her right hand. Design provides greater operator machine control when counteracting torque and kickback forces during digging process.
4. Auger is designed to utilize Brave PN BR10628 (for model BRPA265H) or PN BR10627 (for model BRPA270H) auger pin for auger bit retention to transmission driveshaft. Pin is not intended to shear and absorb kickback related forces when auger bit comes in sudden contact with buried object.
5. Auger pin is utilized for the following reasons:
 - a. Pin shear would result in extensive physical damage to driveshaft and auger drive hub.
 - b. Potentially unknown/large pin quantity could be required to complete digging of any specific hole even if physical damage to Auger could be eliminated and/or minimized.
 - c. Even if replacement auger pin costs are not a factor, resulting productivity produced by actual process would not be acceptable by industry and/or social standards for Auger.
 - d. Given infinite number of potential operators and methods utilized during digging process, it is impossible to design and supply specific auger pins to shear at a specific torque value and produce acceptable operational results for Auger.
 - e. Given infinite number of potential soil conditions, auger diameter, auger boring head condition, digging depth, mechanical operating conditions, operators and operator methods encountered during digging process, it is impossible to design and supply specific auger pins to shear at a specific torque value and produce acceptable operational results for Auger.
6. For comparison purposes, portable electric screwdrivers and drills can utilize a torque limiting or clutch device to allow drill chuck to slip at a limited number of specific torque values. For an Auger, such a device would make the Auger useless due to infinite number of potential operating configurations required and inability to design specific components to meet requirements of each operating configuration.
7. Portable screwdrivers and drills are separate tools designed for different and specific job applications. The drilling process has different requirements than the fastening process for screwdrivers. Portable electric screwdriver and drill operational characteristics cannot be confused and/or substituted for Auger operational characteristics.

6 MACHINE SPECIFICATIONS

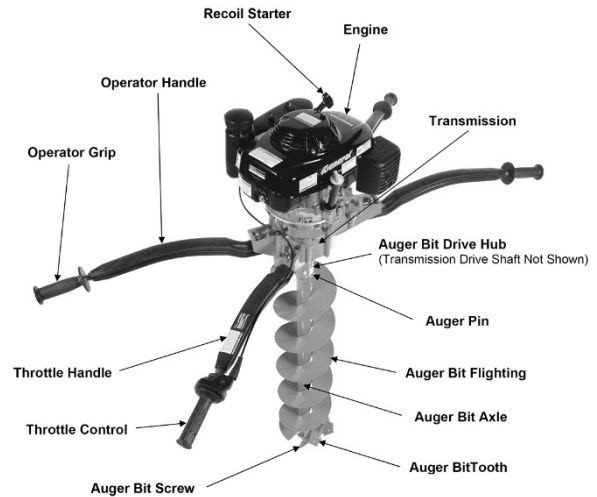

FIGURE 1

ENGINE TYPE	Honda GXV160
HIGH SPEED	3800 RPM (No Load)
IDLE SPEED	1600 RPM
SPARK PLUG GAP	.028 to .031 inch (0.7 to 0.8 mm)
FUEL	Unleaded, “regular” grade gasoline (RON 87). Consult engine manufacturer supplied materials for specific information.
FUEL TANK CAPACITY	1.2 US quart (1.1 L)
TRANSMISSION TYPE	Enclosed, spur geared, double reduction
REDUCTION RATIO	25 to 1
OIL CAPACITY	1 US quart (0.94 L)
OIL	High quality motor oil, service classification SJ, or higher. Refer to TRANSMISSION OIL RECOMMENDATIONS in MACHINE SET-UP section for specific information.
CLUTCH	4 inch (102 mm) diameter, automatic type centrifugal.
MACHINE WEIGHT	71 lbs (32.0 Kg) (less auger)
AUGER CAPACITY	2 inch (50.8 mm) diameter up to and including 18 inch (457 mm) diameter. Refer to DIGGING OPERATION section in this manual for specific information.
OPERATING ENVIRONMENTS	Non-hazardous type locations.
REQUIRED NUMBER OF OPERATORS	2

NOISE & VIBRATION EMISSIONS

Description	North America	Europe
Model	BRPA265H/BRPA270H	
Noise Level	85 db	
Vibration Level	51 m/s ²	

7 STANDARD PRODUCT & ACCESSORIES

Refer to FIGURE 1 for overview description of standard components included in machine. Included in shipment for Auger should be the following:

- 1 each, engine/transmission assembly
- 3 each, curved operator handles with handle grips
- 1 each, curved operator handle with throttle control assembly
- 1 each, bag of assorted hardware
- 1 each, auger pin
- 2 each, bottle of engine oil (for engine crankcase and transmission)
- 1 each, operator manual
- 1 each, applicable engine manual
- 1 each, final inspection form

ACCESSORIES

NOTE: All auger bits, bit extensions, teeth and bit screws are for use in general purpose projects for a variety of soil conditions unless otherwise specified. All auger bits and auger bit extension drive connections are shown below are 1-3/8 inch (35 mm) hexagon. Digging depth for all augers is 36 inches (914 mm). Planting auger digging depth is 30 inches (762 mm) and auger bit extension is 15 inches (381 mm).

	Part #	Description	Cutting Diameter	Weight (in lbs)
	BR10586	4 inch (102 mm) Auger OD	4.5 inch (114 mm)	19.0
	BR10587	6 inch (152 mm) Auger OD	7.5 inch (191 mm)	24.0
	BR10588	8 inch (203mm) Auger OD	9.5 inch (241 mm)	30.0
	BR10589	10 inch (254 mm) Auger OD	11.6 inch (295 mm)	36.0
	BR10590	12 inch (305 mm) Auger OD	13.6 inch (345 mm)	48.0
	BR10591	14 inch (356 mm) Auger OD	15.6 inch (396 mm)	54.0
	BR10592	16 inch (406 mm) Auger OD	17.2 inch (437 mm)	61.0
	BR10593	18 inch (457 mm) Auger OD	19.7 inch (500 mm)	40.0
	5500-15XBR	No Flighting Auger Bit Extension	NA	7.1
	BR10614	Standard Dirt Tooth	NA	3.0
	BR10615	Hardfaced Dirt Tooth	NA	3.2
	BR10616	Chisel Type Dirt Tooth	NA	1.2
	BR10617	Tungsten Carbide Dirt Tooth	NA	1.3
	BR10618	Tungsten Carbide Tooth	NA	1.2
	BR10619	Bit Screw	NA	2.6
	BR10620	Hardfaced Bit Screw	NA	1.0
	BR10621	Bit Screw	NA	4.2
	BR10622	Hardfaced Bit Screw	NA	1.5
	BR10623	Bit Screw	NA	1.6
	BR10624	Hardfaced Bit Screw	NA	1.9
	BR10625	Bit Screw	NA	3.2
	BR10626	Hardfaced Bit Screw	NA	4.5
	BR10628	Auger Pin	NA	0.4

8 MACHINE SET-UP



Open shipping carton immediately upon receipt. Remove Auger from carton. Visually inspect contents of carton for freight damage and/or missing parts. If shipping damage is evident, contact delivering carrier immediately to arrange for an inspection of damage by their claims representative. **DO NOT DESTROY OR DISCARD SHIPPING CARTON UNTIL INSTRUCTED BY AUTHORIZED REPRESENTATIVE OF CARRIER OR FACTORY.** If missing parts are detected, notify your dealer who will assist you in obtaining them.

INSTALLING OPERATOR HANDLES

Tools Required:

- 2 each, 1/2 inch (13 mm) wrench
- 1 each, 5/16 inch (8 mm) wrench
- 1 each, torque wrench, 240 inch pounds (27 Nm) capacity with 1/2 inch (13 mm) socket
- 1 each, small Phillips screwdriver
- 1 each, small vice grip pliers
- 1 each, cut off pliers

Assemble operator handles to transmission on level working platform of appropriate size and height. As an alternative, transmission driveshaft can be securely mounted in suitable bench vice.

1. Open assorted hardware bag into suitable container to prevent component loss.
2. Facing spark plug end of engine, install two curved non-throttle control operator handles into transmission case sockets, arc of curve pointing upward. Use supplied nuts, lock washers and flat washers with threaded end of bolts facing upwards. **FINGER TIGHTEN ONLY. DO NOT FINAL TORQUE FASTENERS AT THIS TIME. FIGURE 2**



FIGURE 2

3. Facing fuel tank end of engine, install remaining curved non-throttle operator handle into transmission case socket located under engine governor control on left side per Step 2.

⚠ DANGER

- **Improper assembly and operation of Magura® throttle control will reduce controllability of Auger, resulting in property damage and/or personal injury.**

4. Install throttle control handle with throttle control grip in remaining transmission case socket. Auger is designed for throttle control grip to be operated by the right hand. **DO NOT** deviate from assembly and operation of throttle control outlined in this manual. Reduced control of Auger will result.
5. Using torque wrench, torque all handle screws evenly to 240 inch pounds (27 Nm).

⚠ CAUTION

- Properly attached operator handles provide proper structural integrity.
- Use of Hole Digger without operator handles properly attached can result in handle failure and/or personal injury.

- Check factory installed throttle control cable is properly retained by cable tie at mid-point on throttle control handle and runs along inside, side area of handle. FIGURE 3

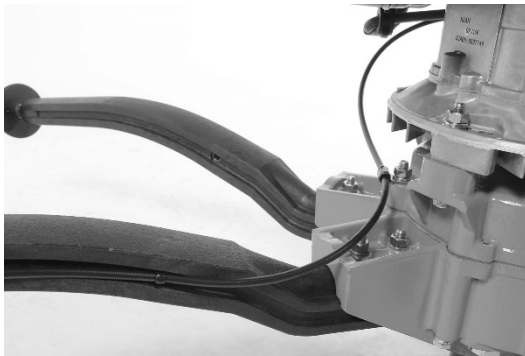

FIGURE 3

- Using Phillips screwdriver, loosen screw on throttle arm swivel. Route free end of throttle control cable into lower location of throttle cable attach bracket and through hole of throttle arm swivel. Attach bracket should be in full contact with aluminum end of throttle cable. Temporarily secure using Phillips screwdriver. FIGURE 4

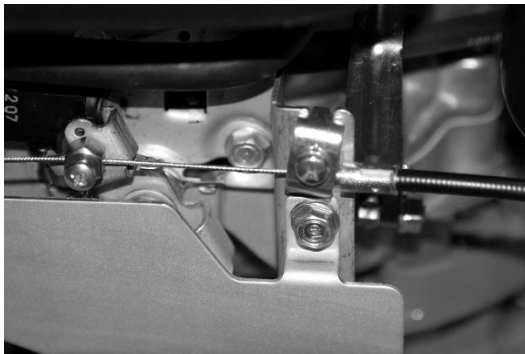

FIGURE 4

- Using Phillips screwdriver, fully tighten throttle cable attach bracket screw. DO NOT allow bracket to crush aluminum throttle cable end. FIGURE 5



FIGURE 5

- Secure throttle cable to transmission cover below fuel tank with supplied clamp. DO NOT allow clamp to crush throttle cable. FIGURE 6

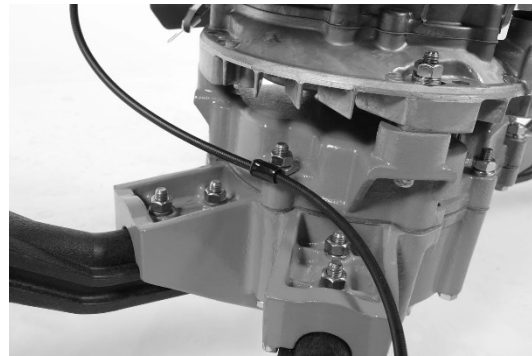

FIGURE 6

- EXTREMELY IMPORTANT:** Using vice grip type pliers, remove any excess inner wire slack from throttle control system and tighten swivel assembly screw using Phillips screwdriver and 3/8 inch (10 mm) wrench. Wire pulling movement must not rotate throttle control grip. When throttle control grip is released, throttle arm return spring must immediately cut engine power off. If not occurring, check throttle control grip assembly for binding/movement restrictions. Adjust swivel assembly as necessary for complete freedom of movement. FIGURE 7

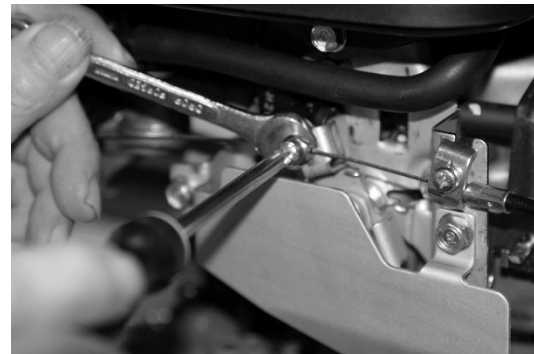

FIGURE 7



WARNING

- For operational safety and productivity considerations, it is extremely important that inner wire slack be completely removed from throttle control system.
- Inner wire slack can reduce overall operator control, resulting in property damage and/or personal injury.

- Rotate throttle control counterclockwise (maximum speed position). Check inner wire pulls throttle lever arm of carburetor forward against stop. Improper adjustment prevents engine to operate at maximum, no load, governed speed and affects overall digging performance of Auger. Adjust swivel assembly and throttle cable attach bracket as necessary for complete freedom of movement.
- Check throttle cable inner wire for binding/movement restrictions caused by attach bracket. Adjust bracket as necessary for complete freedom of movement.
- Using cut off pliers, cut remaining inner wire behind swivel arm assembly, leaving approximately 1 inch (25.4 mm) of excess wire. Re-install air intake cover.
- Check all fasteners for security, tighten as required.

NOTES TO THROTTLE CABLE INSTALLATION

- The Honda GXV160 engine incorporates a multi-purposed carburetor/throttle arm design allowing use with Bowden (push) and braided wire (pull) type configurations. For simplicity, the Auger incorporates a braided wire (pull) type configuration.
- The GXV160 engine utilizes a one or two spring loaded screws as stops for the carburetor throttle arm.

- a) If equipped, the shorter (inner) screw is non-functional for this application.
- b) The longer (outer) screw is factory set to prevent the engine from operating in an overspeed configuration. As set from the factory, the GXV160 engine will operate at approximately 3800/3900 RPM no load. In a no-load configuration the engine is operating at maximum governed speed without an earth auger attached to the transmission drive shaft.

2. Wipe any dust or dirt from transmission oil plug area located on transmission bottom. Remove plug with wrench.
3. Using funnel, pour 24 fluid ounces (0.7 L) of Transmission and Engine Oil, PN 999-11, or a high grade, SAE 10W30, service classification SJ or higher motor oil through plug opening. FIGURE 8
4. Maintain oil level in transmission at bottom of oil plug hole. Allow any excess oil to drain out of transmission. This procedure determines correct oil level for transmission. DO NOT operate Hole Digger with improper oil level.

CAUTION

- DO NOT alter engine throttle control arm or spring positions regulating maximum engine speed.
- Improper setting can result in excessive engine speed leading to substandard digging performance and loss of operator control that can result in property damage and/or personal injury.

WARNING

- Determine all components of engine throttle control assembly allow for proper function.
- Throttle lever of carburetor must return engine to idle speed, as stated in MACHINE SET-UP section of this manual, when twist grip throttle is released by operator.
- If proper function does not occur, contact your dealer or customer service department for specific information to correct the situation.
- DO NOT operate Auger until improper function has been corrected.
- An improperly functioning throttle control can result in property damage and/or personal injury.

NOTE: Correct oil level is important to ensure proper centrifugal clutch operation. Maintaining oil level too high will cause excessive clutch slippage and result in high oil temperatures. Excessive slippage and high oil temperatures will significantly reduce service life of clutch assembly and affect overall performance of Auger.

NOTE: Use only an oil marked with an engine service classification SJ or higher. As a general rule, the transmission usually uses same oil type and weight as the 4-Stroke engine crankcase.



FIGURE 8

>>>> BEFORE STARTING ENGINE <<<<



FILLING ENGINE CRANKCASE WITH OIL

Tools Required:

1 each, small, clean funnel with a flexible extension spout

Fill engine crankcase with oil on level working platform of appropriate size and height. As an alternative, transmission driveshaft can be securely mounted in suitable bench vise.

1. Wipe any dust/dirt from crankcase dipstick/filler plug area. Remove dipstick/filler plug.
2. Using funnel, add oil to engine crankcase. For proper classifications and/or amount, consult material supplied by engine manufacturer for specific information.
3. Replace dipstick/filler plug and tighten. Wipe off any excess spilled oil. Properly dispose of spilled oil/rags per international and local regulations.

5. Reinstall oil plug. Tighten securely with wrench. Wipe off any excess oil spilled on transmission. Properly dispose of spilled oil/rags per international and local regulations.

TRANSMISSION OIL RECOMMENDATIONS

Operating Temperature	Oil Type & Weight
Above 0°C (32°F)	SAE 30, 10W30, 10W40, 15W40
Below 0°C (32°F)	SAE 5W30

WARNING

- DO NOT operate Hole Digger unless proper oil level is maintained.
- Improper oil level can result in property damage and/or personal injury.
- Consult material supplied by specific engine manufacturer for information relative to proper maintenance procedures.

FILLING ENGINE FUEL TANK



Tools Required:

1 each, small, clean funnel.

CAUTION

- Never mix oil with gasoline for use in a 4 cycle engine. Damage to engine can result. Four cycle engines do not utilize oil mixed with gasoline for lubrication purposes.

FILLING AUGER TRANSMISSION WITH OIL

Tools Required:

1 each, 15/16 inch (23.8 mm) open or closed end wrench or use a socket/ratchet combination

1 each, small, clean funnel with a flexible extension spout.

1. Position Auger vertically, engine spark plug facing up and bottom of transmission housing facing toward you. Support to prevent accidental movement. FIGURE 8

BEFORE operating Auger refer to MACHINE SPECIFICATIONS section in this manual and engine manufacturer supplied materials for information regarding engine fuel, fueling and lubrication requirements.

1. Use extreme caution handling gasoline. Always use UL, CSA or UN marked, European ADR regulation approved container for storage and transportation of fuel. Shut engine off and allow to cool before fueling. Never remove fuel tank filler cap or fill fuel tank while engine is running. Never operate engine without fuel tank filler cap. Select bare ground for fueling and move at least 10 feet (3.05 M) from fueling spot before starting engine.
2. Carefully clean filler cap and surrounding area to prevent dirt/debris falling into fuel tank.
3. Fill fuel tank with fresh, clean, unleaded automotive gasoline. Leaded "regular" grade gasoline is acceptable substitute. **DO NOT USE GASOLINE CONTAINING METHANOL (WOOD ALCOHOL).** Gasoline containing maximum 10 percent ethanol/grain alcohol (sometimes referred to as Gasohol) may be used but requires special care when storing engine for extended periods.

NOTE: DO NOT use gasoline left over from previous season for easier engine start-up and prevent poor engine performance.

4. DO NOT completely fill tank. Fill tank to within 1/4 inch (7 mm) to 1/2 inch (13 mm) of tank top to allow for fuel expansion. Replace filler cap. Wipe any fuel spillage and oil if leak is detected from engine and Auger BEFORE operating engine. DO NOT operate engine until leak is fixed plus, fuel and oil are wiped away. Properly dispose of any fuel or oil wiped from machine/rags per international and local regulations. DO NOT allow fuel or oil to get on clothing. Change clothes immediately if this happens.



DANGER

- DO NOT smoke near fuel tank.
- DO NOT fill fuel tank with engine running or if it is hot.
- Allow ample time between each refueling for engine to cool.
- An ignition source in close proximity to fuel tank can be the source of an explosion, resulting in property damage and/or personal injury.
- Consult material supplied by engine manufacturer for information relative to proper fueling procedures.

9 APPLICATION THEORY & TECHNIQUES



The Auger operates on principle of accessory auger bits attached to the transmission drive shaft to rotate and dig holes in a variety of soil types. The combination of auger bit diameter, teeth, screw, soil type and down pressure supplied by operators will affect the hole digging rate.

Hole digging process is directly controlled by:

1. Soil type.
2. Auger bit boring head design and diameter selected.
3. When required, sufficient application and/or reduction of machine weight and/or down force provided by operators to assist auger soil penetration.
4. No two soil types are exactly alike, no two holes can be dug by exact same method, overall operator feed rates vary. The hole digging process, along with operator experience, skill and common sense, suggests hole digging is a matter of trial and error and directly determines overall success of the job application.

HOLE DIGGING TECHNIQUES

1. Normal Auger operation runs engine at full, governed speed allowing centrifugal clutch to become firmly engaged. Technique transmits more usable power to auger bit, increasing productivity and reducing component wear. For any soil condition, allow auger bit to dig at rate most comfortable to operators, but not cause centrifugal clutch to overload and slip.

NOTE: Auger is equipped with a centrifugal clutch assembly within the transmission. The clutch assembly is designed to ALWAYS slip (NOT DISENGAGE) when overloaded or if auger contacts buried obstruction. When slipping, clutch still transmits a specific amount of torque to auger. Response time for clutch to react to overload condition is directly proportional to rotational speed. With higher rotational speeds (RPM) of clutch at time of overload, it takes more time for clutch to react and actually slip.



CAUTION

- Improper operating procedure can allow auger bit to "bind" and/or "bury" itself in the hole.
- This is usually the result of allowing auger bit to feed at an excessive rate. Phenomenon is also characteristic of digging with smaller diameter (2 to 4 inch) augers.
- In this condition, Auger is not capable of transmitting ample power to "free" auger bit.
- DO NOT continue to overload and slip centrifugal clutch assembly.

2. In general, pressing down on operator handles is not required to initiate and/or sustain the digging process. In most moderate density soils, auger bit dig rates will not cause centrifugal clutch to overload and slip. In most soft, low density soils (sandy, etc.), it may be necessary to hold up on operator handles to reduce auger bit dig rate due to tendency of any auger bit design to cause centrifugal clutch to overload and slip. In most hard, high density soils (hard clay, etc.), it may be necessary to press down on operator handles to establish and maintain acceptable dig rates.
3. Some soil conditions may require more power to dig than machine is capable of delivering for a given auger diameter. To minimize problem, apply suitable down force by operators and use auger bits with new bit screws and teeth. DO NOT use more than two operators to apply down force. If it is felt more than two operators are required to apply down force, STOP and contact Customer Service Department for operational recommendations.
4. When digging in areas filled with known, buried obstructions such as tree roots, rocks and other debris, operate Auger at less than full (an intermediate) speed for more rapid release of centrifugal clutch when obstruction is encountered. This is an industry wide operating procedure.
5. When digging in areas filled with small tree roots, small rocks or other buried obstructions, allow auger bit teeth to "chip away" at obstruction until auger bit can pass by (by working object loose) or go through it (as in penetrating tree roots). Technique usually involves holding up on operator handles using minimal auger bit feed rate. Many times, size and nature of buried object will prevent auger bit from passing by or going through it. Instead, remove buried object with shovel or other suitable tool and proceed to dig to desired depth using Auger.



CAUTION

- Some job applications may encounter buried obstructions too massive in size or soil classifications too compacted to allow use of machine the size and/or with operating limitations of Auger.
- Utilization of Auger on these work sites can cause property damage and/or personal injury.
- Exercise proper common sense by selecting proper size and/or type equipment for the job application.

6. In most soil conditions, the auger bit will retract with less effort if allowed to rotate at slow speed. This procedure, however, will leave more loose soil at bottom of hole. To minimize amount of loose soil remaining at bottom of hole, stop rotation before retracting auger bit.
7. When restarting a Auger with auger bit in a partially or completely dug hole extra caution is required. The throttle control can be advanced beyond idle speed before operators can exercise proper control of Auger. The accepted procedure (when not using non-flighted auger bit extension) is to first remove unit from hole and restart engine per STARTING ENGINE WITH AUGER BIT ATTACHED in OPERATING INSTRUCTIONS section of this manual. Return unit to hole with engine at idle speed and complete hole to desired depth.

CAUTION

- Restarting engine with auger bit in partially or completely dug hole requires higher degree of operator experience, skill and common sense over introductory or novice level expertise.
- Manufacturer is aware many operators restart Auger's engine with auger bit in partially or completely dug hole on regular basis while in the field.
- Manufacturer also realizes procedure must be utilized when auger bit extension is used to extend digging depth. Manufacturer has no control over experience, skill and common sense levels of each operator of the Auger.
- Manufacturer has no control over each job site or specific job application for the Auger.

8. Grass and other overgrowth conditions will hamper digging capability of any auger bit by becoming "clogged" around auger bit teeth and screw. Removal of such obstructions from hole location BEFORE digging will increase digging efficiency and overall productivity.

CAUTION

- DO NOT dig initial hole with smaller auger bit then use larger diameter auger bit to "ream" hole to desired size.
- This method will prevent auger bit screw of larger auger bit from providing sufficient directional stability during "reaming" process.

WARNING

- DO NOT use shovel and/or foreign object to remove loose soil from around hole area while operating Auger.
- This can result in shovel and/or foreign object to become entrapped by rotating auger bit.

10 OPERATING INSTRUCTIONS



IMPORTANT: DO NOT operate Auger until each operator completely comprehends contents of this manual, plus applicable safety and operational information supplied by engine manufacturer.

INSTALLING AUGER BIT

1. Refer to STOPPING AUGER in OPERATING INSTRUCTIONS section of this manual. To install auger bit, place Auger with spark plug facing up.

DANGER

- DO NOT connect auger to Hole Digger with engine running.
- A sudden change in engine speed will result in property damage and/or personal injury.

2. Connect auger bit to Auger with correct factory supplied auger pin. Model BRPA265H Auger uses 3/8 inch (9.5 mm) diameter pin P/N BR10628. Model BRPA270H Auger uses 5/16 inch (8 mm) diameter pin P/N BR10627.

CAUTION

- When installing auger bit and auger pin, always place Auger with engine spark plug in upward position to minimize potential for oil and/or gasoline to enter combustion chamber and create a hydraulic lock up.
- Such occurrence can result in property damage and/or personal injury.

CAUTION

- DO NOT use any other connecting device except auger pin supplied with Auger which is designed to withstand high stresses encountered while digging.
- Use of any other connecting device, including cap screws, bolts, pins, etc., can result in damage to Auger driveshaft and/or auger bit drive hub.
- Improper connecting devices can cause property damage and/or personal injury.

STARTING ENGINE WITH AUGER BIT ATTACHED

DO NOT attempt to dig with Auger until Crew Chief and Crew Member have acknowledged to each other they are ready and are in full control of machine/accessories. Crew Chief operates engine throttle control with right hand and is responsible for verbal commands. Crew member operates choke control and starts engine.

DANGER

- Auger is designed for two operators. Use by only one operator or by more than two operators will lead to confusion and loss of control, resulting in property damage and/or personal injury.
- Start engine according to instructions outlined below to minimize possibility of unexpected auger rotation.
- Unexpected auger bit rotation can result in loss of machine control and possibility of property damage and/or personal injury.

DANGER

- To reduce potential for personal injury, stop Auger between each hole.
- DO NOT choose to save time (time required to restart engine), money (if Auger is being rented) or gain added convenience by electing to keep engine running between each hole.
- Actions can lead to loss of control, resulting in property damage and/or personal injury.

CAUTION

- If Auger and/or an individual component/accessory does not appear to function properly, STOP and DO NOT operate Auger until corrective action has been completed.
- If you have any questions regarding proper operation of Auger, contact Customer Service Department for assistance BEFORE using. There is no charge for this service.

3. Place Auger in vertical orientation on desired hole location.
4. Crew Member opens fuel tank breather vent (if so equipped) to its maximum set position. Failure to open breather vent prevents engine from receiving continuous supply of fuel.
5. Crew Member opens fuel tank ON/OFF valve located under fuel tank to ON position as shown. FIGURE 9



FIGURE 9

6. Crew Chief rotates throttle control counterclockwise (to open) half way against its stop while providing machine stability with left hand/left handle grip.
7. Crew Member closes engine choke located above carburetor by pulling control lever out to its detent position. FIGURE 10

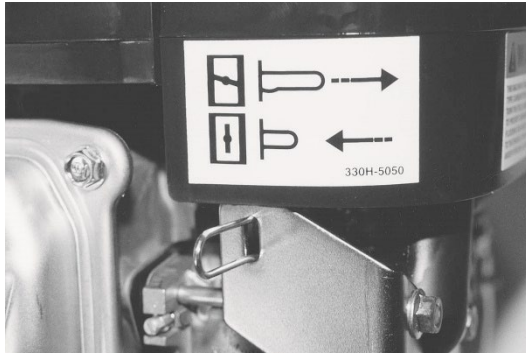



FIGURE 10



FIGURE 11

 **CAUTION**

- DO NOT apply excessive force when pulling or pushing choke lever control.
- Excessive force can damage carburetor.

8. Crew Member pulls recoil starter handle slowly until resistance is felt (this is the compression point), then gives a fast, short, steady pull. Allow starter rope to retract slowly. If engine does not start in three pulls, consult material supplied by engine manufacturer for specific information. As engine warms up, Crew Member pushes choke control into its detent position. FIGURE 10

NOTE: Normally, engines not running for some time require three to five pulls to start. Recently run engines usually start on first or second pull. In cold weather, initial starting will require additional pulls due to extremely rich fuel/air mixture.

9. Allow engine to properly "warm up" and operate without requirement for engine choke. Check for proper centrifugal clutch operation, excessive transmission noise and/or vibration.
10. Crew Chief rotates throttle control counterclockwise to increase engine speed/regulate digging process. Auger bit begins rotation when centrifugal clutch reaches initial engagement speed.

PROPER OPERATOR STANCE (FIGURE 11 & 12)

11. Grasp operator handles firmly. Wrap fingers around handle grips, keeping grips cradled between thumbs and forefingers.
12. Keep wrists as perpendicular to operator handles as feasible while digging. Proper wrist position can minimize and/or reduce stress and strain related damage potential to this body area, plus, operator control is enhanced and fatigue reduced. FIGURE 12
13. Keep left side operator handles as close to waist/leg/arm areas as possible for maximum leverage/control and minimize effects of "kickback" if obstruction is encountered when digging.
14. Keep arms close to upper body, back as vertical as possible, and bend legs as needed to minimize physical stress.
15. Position left foot forward of right foot and a comfortable distance apart.



FIGURE 12

NOTE: Not using a proper operator stance (FIGURES 13, 14, 15):

- a) Reduces operator control and balance.
- b) Increases operator fatigue.
- c) Increases risk of property damage and/or personal injury.



FIGURE 13



FIGURE 14



FIGURE 15

REMOVING STUCK AUGER BIT FROM HOLE



16. Usually due to excessive auger bit feed rate, an auger bit can "bind" and/or "bury" itself in the hole. This is also common when digging with smaller diameter 2 inch (50.8 mm) to 4 inch 101.6 mm (101.6 mm) auger bits. When this occurs, **DO NOT** continue to overload and slip clutch assembly. Auger is not capable of transmitting ample power to "free" auger.

 **WARNING**

- Auger-LOK™ System is designed for manual engagement and activation by the operators.
- **DO NOT** use chains and/or slings wrapped around Auger and/or operator handles connected to external towing device such as a truck or loader to remove stuck auger bit.
- Improper action can result in property damage and/or personal injury.

NOTE: The Auger uses a manually deployed transmission lock to prevent gear rotation. Use the following procedure to remove a stuck auger bit from hole:

17. Before attempting to remove stuck auger bit from hole, STOP engine per STOPPING AUGER in OPERATING INSTRUCTIONS section of this manual BEFORE moving to step 18 below.
18. Locate transmission lock on top of transmission housing under spark plug/engine cooling fin area of engine. FIGURE 16

 **CAUTION** 

- Area can become hot to the touch.
- Wear gloves for added protection.



FIGURE 16

19. Push lock handle down slightly to disengage upper detent position. Turn lock handle counterclockwise (to right) until it stops against vertical slot of lock bracket. FIGURE 16
20. Push lock handle down until it stops against bottom slot of lock bracket and engages transmission gear. (Note, it may be necessary to rotate Auger back and forth slightly to allow lock pin to fully engage gear.) Turn lock handle clockwise (to left) until it stops against right side of slot. Release allowing spring to push handle up into lower detent position. In this position, lock device is fully deployed. FIGURE 17

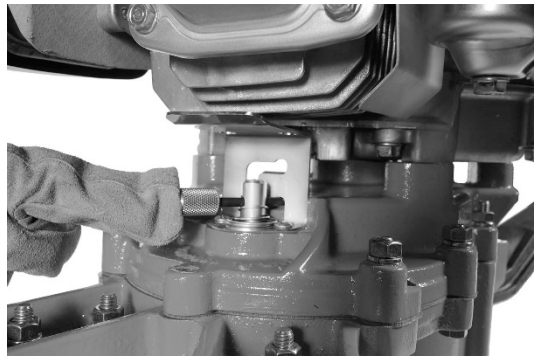



FIGURE 17

21. With Crew Chief and Crew Member on each side of Auger, grasp operator handles and rotate Auger/auger bit counterclockwise (to left). **DO NOT FORCE.** Apply steady pressure until auger bit loosens in ground, continuing rotation until auger bit is freed from obstruction and Auger/auger bit can be lifted from hole.
22. Inspect Auger/auger bit for damage. Remove any obstruction from auger bit and/or hole.
23. Reverse locking device process to disengage locking pin from gear. Check spring positions handle in upper detent position of locking bracket to prevent inadvertent lock deployment.

 **CAUTION**

- Lock device spring should always be in direct contact with handle in any position.
- If this does not occur, lock device can become inadvertently deployed, resulting in property damage and/or personal injury.
- Replace worn or damaged spring with factory approved replacement part only.

24. Reconnect spark plug wire. Start engine and resume digging process per STARTING ENGINE WITH AUGER BIT ATTACHED in OPERATING INSTRUCTIONS section of this manual.

ADDING/REMOVING NONFLIGHTED & FLIGHTED AUGER BIT EXTENSION

For holes deeper than standard auger bits provide, a non-flighted auger bit extension increases digging depth 15 inches (381 mm). A flighted auger bit extension increases digging depth 36 inches (762 mm). Additional operator experience, over introductory/novice skill levels, is required when using. Follow this accepted procedure to add non-flighted bit extension:

25. Dig to approximate full depth of auger bit following operating instructions. Remove as much loose soil from hole as possible per STEP 6 of HOLE DIGGING TECHNIQUES in APPLICATION THEORY & TECHNIQUES section of this manual.
26. STOP Auger per STOPPING AUGER in OPERATING INSTRUCTIONS section of this manual.
27. Remove Auger/auger bit from hole. Disconnect auger bit from Auger. Place auger bit in hole. Attach auger bit extension to auger bit and secure with auger pin. The Auger can now be connected to auger bit extension using auger pin.



FIGURE 18



CAUTION

- Utilization of non-flighted/flighted auger bit extensions requires additional operator experience, skill and common sense over introductory or novice level of expertise.
- Manufacturer has no control over experience, skill and common sense levels of each operator of Auger.
- Each operator must decide if his experience, skill and common sense level is sufficient to allow him to proceed with use of non-flighted/flighted auger bit extensions for any given and/or specific job application.



WARNING



- **Never utilize more than one non-flighted auger bit extension to increase overall digging depth.**
- **Non-flighted auger bit extensions are not equipped with auger flighting to elevate loose borings from hole.**
- **Multiple use of non-flighted auger bit extensions will allow auger to “bury” itself in hole. Such use can lead to loss of operator control and/or personal injury.**



FIGURE 19

28. Per STARTING ENGINE WITH AUGER ATTACHED in OPERATING INSTRUCTIONS section of this manual, dig to desired depth or to full depth of auger bit extension. To remove auger bit extension, follow this accepted procedure:
29. STOP Auger per STOPPING Auger in OPERATING INSTRUCTIONS section of this manual.
30. Remove as much loose soil from hole as possible per STEP 6 of HOLE DIGGING TECHNIQUES in APPLICATION THEORY & TECHNIQUES section of this manual.
31. Lift auger bit extension/auger bit/Auger up far enough out of hole so bottom end of auger bit extension is clear. FIGURE 18. Block remaining auger bit with auger fork to prevent falling back into hole. An additional Crew Member will usually be required. FIGURE 19

32. Disconnect Auger from auger bit extension. Disconnect auger bit extension from auger bit.
33. Reconnect Auger to remaining auger bit and remove power unit/auger bit from hole. Reconnect spark plug wire.
34. Per STARTING ENGINE WITH AUGER BIT ATTACHED in OPERATING INSTRUCTIONS section of this manual dig next hole based on job application. If project is complete, store Auger per STORAGE section of this manual.



STOPPING AUGER

35. Stop Auger by releasing throttle control grip. Power to engine should immediately be cut off. FIGURE 20



FIGURE 20

NOTE: If engine power does not cut off, check throttle control grip, throttle cable, and engine throttle control arm for binding and/or improper adjustment.

 **WARNING**  

- Stop Hole Digger between each hole.
- Never leave Hole Digger running and unattended.
- Not doing so can result in property damage and/or personal injury.

36. Disconnect spark plug wire to prevent accidental engine starting.
37. When engine is not in operation or is to be stored, close fuel tank breather vent (if so equipped). Turn fuel tank ON/OFF valve to OFF position to minimize fuel flooding carburetor and/or entering engine crankcase and/or impacting upon environment.

11 MAINTENANCE INSTRUCTIONS



For routine maintenance, the following information should be followed once per week or 40 hours of use at minimum for maximum performance and return on investment unless otherwise indicated. Information is for reference only and is not intended to be all inclusive.

1. Use factory approved replacement parts/accessories only for maintenance and repair.

 **WARNING**







- Operating Auger utilizing components not meeting minimum operational standards can result in property damage and/or personal injury.

2. All maintenance/repairs not described in this operator manual must be done by a dedicated service center following a specific service/repair manual.
3. STOP Auger BEFORE performing maintenance and service per STOPPING AUGER in OPERATING INSTRUCTIONS section of this manual.

 **WARNING**

- DO NOT perform service and/or repair related functions with Auger mounted to 999 Series Display Stands.
- Stands are not designed and/or intended for hole digging and service functions.
- Such use can result in property damage and/or personal injury.

4. Inspect for loose or broken parts. Inspect all fasteners, individual parts, operator controls and safety devices for proper function. Tighten fasteners as necessary. Replace any worn or damaged part or assembly.
5. Remove all loose accumulations, dirt, grease to prevent safety hazards, poor performance and reduced service life using safety type solvent.

 **DANGER**      

- Use safety type solvent.
- DO NOT use thinner, benzene, or other volatile solvents that will attack rubber/plastic components when cleaning Auger.
- Provide adequate ventilation.
- DO NOT smoke while using cleaning solvents.
- DO NOT use solvents with engine running or if it is hot.
- Allow ample time for engine to cool BEFORE using solvents.
- An ignition source in close proximity to hot engine can be the source of an explosion, resulting in property damage and/or personal injury.

6. Inspect engine throttle control arm and throttle cable assemblies are not damaged, bent, abraded or parts missing, are in correct operating position and allow for complete freedom of movement. DO NOT operate Auger with damaged engine throttle control arm and/or throttle cable assembly.
7. Inspect operator grips and throttle control grip are free of moisture, pitch, oil or grease and are not cracked, damaged or worn. DO NOT operate Auger until such handles and/or grips are repaired and/or replaced to prevent aggravated effects of "kickback and/or loss of operator control when digging.
8. Inspect operator handle full length and attach areas for signs of cracking, fatigue, deformation, nicks or gouges. If cracking or deformation is detected or cuts or abrasions greater than 0.125 inch (3.2 mm) deep are present, replace. Keep handles clean and free of dirt, moisture, grease, oil and other, foreign material accumulations.

IMPORTANT: Keep external condition of operator handles, grips and throttle control free of accumulation of moisture, dirt, pitch and other foreign substance that can provide a conductive pathway for energy to be transmitted. Throttle control should be maintained in clean, dry condition and free of all foreign materials.

IMPORTANT: Regardless of actual use, operator handles have a maximum service life of 6 years. Replace any operator handles meeting this time limit. Handle material used reduces (but does not eliminate) long term effects of ultra violet radiation from sun.

9. Inspect centrifugal clutch assembly properly disengages at specified engine speed or slips during overload conditions.
10. Inspect engine muffler for wear or damage and replace as necessary to minimize fire hazard and hearing loss risk. If muffler is equipped with a spark arresting device, check for proper working condition. If not, replace with approved replacement from engine manufacturer.

IMPORTANT: It is owner(s) and/or operator(s) responsibility to provide and maintain a USDA approved, spark arresting muffler in an operating area specified by law. Check appropriate governing agencies for more specific information. Auger must not be operated if muffler is faulty or has been removed.

11. Inspect all safety and operation decals. If any decal becomes damaged and/or unreadable, replace.
12. Auger may utilize self-locking type hexagon nuts to minimize effects of vibration. If worn or damaged, replace.
13. Inspect auger bit for bent or damaged axle that will cause auger bit to "wobble" during use and can cause loss of machine control. Maximum allowable auger bit wobble is 0.25 inch (7 mm) total indicator runout (TIR). Auger bits with TIR in excess of this value must be removed from service and scrapped.
14. Inspect auger bit teeth and screw for excessive wear, cracking, sharpness and missing parts. Replace as required to prevent undo wear to boring head and inverted cone configuration to auger flighting. The end result is substandard productivity and usually requires complete auger bit replacement. FIGURE 21. Auger bit service life can be greatly extended with constant auger wear part maintenance.



FIGURE 21



WARNING

- **DO NOT use auger bit with auger teeth and screw worn past their specific service limits.**
- **Excessive wear to auger teeth and screw will allow auger bit flighting to wear in a tapered or inverted cone configuration.**
- **A worn boring head may only be capable of digging a hole 60 to 75 percent of auger bit nominal diameter.**
- **Configuration will allow auger bit to "bind" in hole and substantially reduce operator control and productivity.**



DANGER

- **DO NOT operate auger bit which has bent or damaged axle with total indicator runout exceeding maximum allowable limit.**
- **Excessive auger bit wobble can reduce operator control, resulting in property damage and/or personal injury.**

15. Consult material supplied by engine manufacturer for specific information relative to proper operation, lubrication and storage requirements.

CHANGING AUGER TRANSMISSION OIL

Tools Required:

- 1 each, 15/16 inch (24.8 mm) open or closed end wrench or use a socket/ratchet combination
- 1 each, small, clean funnel with a flexible extension spout.

NOTE: Changing transmission oil will require a level working platform of sufficient size and appropriate height. As an alternative, the transmission output driveshaft can be securely mounted in suitable bench vise.

1. Change transmission oil every 25 hours of operation, or more often as necessary, if Auger is operated in extremely dusty or dirty conditions.
2. STOP Auger per STOPPING AUGER in OPERATING INSTRUCTIONS section of this manual.
3. Drain fuel from fuel tank into a UL, CSA or UN marked, European ADR regulation approved fuel container. Wipe any excess spilled fuel and dispose of excess fuel and/or rags per international and local regulations.



DANGER



- **DO NOT smoke near fuel tank.**
- **DO NOT fill fuel tank with engine running or if it is hot.**
- **Allow ample time between each refueling for engine to cool.**
- **An ignition source in close proximity to fuel tank can be the source of an explosion, resulting in property damage and/or personal injury.**
- **Consult material supplied by engine manufacturer for information relative to proper fueling procedures.**

4. Position Auger vertically, engine spark plug facing up and bottom of transmission housing facing toward you. Support to prevent accidental movement.
5. Wipe any dust or dirt from oil plug area located on transmission bottom. Remove plug with wrench.
6. Tilt unit forward to allow oil to completely drain from transmission into a suitable container.
7. Re-position unit back to vertical position with spark plug facing up. Using funnel, pour 24 fluid ounces (0.7 L) of Transmission and Engine Oil, PN 999-11, or a high grade, SAE 30 Detergent or 10W30 motor oil through plug opening.
8. Maintain oil level in transmission at bottom of oil plug hole. Allow any excess oil to drain out of transmission. This procedure determines correct oil level for transmission. DO NOT operate Auger with improper oil level.

NOTE: Correct oil level is important to ensure proper centrifugal clutch operation. Maintaining oil level too high will cause excessive clutch slippage and result in high oil temperatures. Excessive slippage and high oil temperatures will significantly reduce service life of clutch assembly and affect overall performance of Auger.

NOTE: Use only an oil marked with an engine service classification SJ or higher. As a general rule, transmission usually uses same oil type and weight as 4-Stroke engine crankcase.

9. Inspect oil plug gasket, replace if worn. Reinstall oil plug. Tighten securely with wrench. Wipe off any excess oil spilled on transmission. Dispose of used oil/rags per international and local regulations.

MAGURA® THROTTLE CONTROL MAINTENANCE PROGRAM

For every 8 hours of actual operation and whenever throttle cable is replaced, the following maintenance program is to be followed:

1. Remove plastic cover to properly inspect internal components. If damaged or worn, replace. FIGURE 22



FIGURE 22

2. Inspect idler pulley. Normal use will produce a wear pattern into idler pulley by throttle cable. Maximum allowable groove wear depth created by cable is 0.045 inch (1.1 mm). Wear depth in excess of this limit requires idler pulley replacement.
3. Inspect throttle cable for excessive wear and fraying of area in direct contact with idler pulley. Abnormal wear or fraying requires replacement of throttle cable.
4. Inspect barrel end of throttle cable for proper retention. Properly retained barrel end will have no relative movement between it and inner cable. Any relative movement requires throttle cable replacement. FIGURE 23



FIGURE 23

5. Inspect receptacle area of throttle control which retains barrel end of throttle cable. Properly fitted barrel fitting should have complete freedom of movement with no binding restrictions or excessive play due to wear. Barrel fitting which is binding within receptacle requires throttle cable replacement. Excessive receptacle wear requires specific component assembly replacement. FIGURE 24



FIGURE 24



CAUTION

- DO NOT operate Auger without rubber boot in proper location or in poor condition.
- Without boot assembly, foreign material can accumulate within throttle control assembly.
- Such an occurrence can restrict movement of internal components, reducing operator control of Auger and result in property damage and/or personal injury.

6. Apply appropriate preservative to rubber boot assembly to protect internal components from foreign material accumulations.
7. If regular throttle control inspection determines carburetor return spring does not properly return to engine cut-off position, remove throttle control grip tube from throttle control handle. Inspect tube and operator handle surface area for accumulation of foreign material, including dirt, moisture, etc. Remove any accumulation, clean as necessary. DO NOT apply external lubrication to this area during reassembly process.
8. Inspect throttle control grip proper attachment to throttle control assembly. Replace grip which fits loose or has become worn/damaged.

REPLACING WORN AUGER BIT SCREW

Application: All 1-3/8 inch hexagon and 7/8 inch square drive series auger bits.



DANGER

- Wear safety eyewear and other safety apparel appropriate for the job application and/or job site environment.
- Screw bit replacement process can create flying steel chips and/or other debris.
- Caution all onlookers regarding the possibility of and/or to remain clear of flying debris.
- Improper safety procedures can result in property damage and/or personal injury.

Tools Required:

- 1 each, safety glasses
- 1 each, hammer
- 2 each, 1/2 inch (14 mm) wrenches

Parts Required:

- 1 each, PN BR10619 Screw Bit 14 inch (355.6 mm) to 18 inch (457.2 mm) diameter auger bits
- 1 each, PN BR10621 Screw Bit for 6 inch (152.4 mm) to 12 inch (304.8 mm) diameter auger bits
- 1 each, PN BR10625 Screw Bit for 4 inch (101.6 mm) diameter auger bit

NOTE: Tungsten Carbide versions of each screw listed above are available. These optional hardfaced screw bits will not increase overall productivity rates, but will increase anticipated service life of the screw bit.

NOTE: Replacement of auger bit screw will require a level working platform of appropriate size and height.

1. Using wrenches, remove cap screw retaining bit screw to the auger bit drive lug. Remove bit screw and properly dispose of.

2. Inspect auger bit drive lug for signs of excessive wear and/or damage. To replace drive lug, remove by using suitable saw or cutting torch.
3. Install replacement bit screw and retaining hardware. Hardware is unidirectional. Secure tight with wrenches.
4. Return auger bit back to service.

REPLACING WORN AUGER BIT TEETH

Application: All 1-3/8 inch hexagon and 7/8 inch square drive auger bits.



DANGER

- Wear safety eyewear and other safety apparel appropriate for the job application and/or job site environment.
- Screw bit replacement process can create flying steel chips and/or other debris.
- Caution all onlookers regarding the possibility of and/or to remain clear of flying debris.
- Improper safety procedures can result in property damage and/or personal injury.

Tools Required:

- 1 each, safety glasses
- 2 each, 1/4 inch (6.4 mm) diameter drift punch.
- 1 each, plastic hammer or soft type hammer designed for impact use.

Parts Required:

- Required Quantity, PN BR10614 Standard Dirt Tooth or,
- Required Quantity, PN BR10615 Hardfaced Dirt Tooth or,
- Required Quantity, PN BR10616 Chisel Tooth or,
- Required Quantity, PN BR10617 Tungsten Carbide Chisel Tooth or,
- Required Quantity, PN BR10618 Tungsten Carbide Tooth

NOTE: Replacement of auger bit teeth will require level working platform of appropriate size and height.

1. Using hammer and drift punch, strike the visible end of tooth located in tooth retention slot. Repeat action until worn tooth becomes loose and can be removed. FIGURE 25

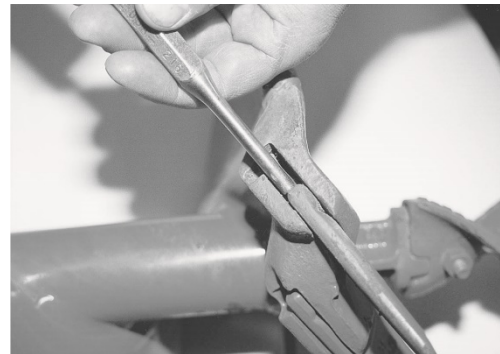

FIGURE 25

2. Remove worn rubber lock from tooth retention slot. Both round and flat locking device configurations are utilized.
3. Inspect tooth retention slot area of casting for excessive wear and/or damage.

NOTE: A tooth retention socket with excessive wear will not properly support a replacement tooth. Excessive wear usually indicates an auger bit is worn beyond its useful service life and should be removed from service. An auger bit with excessive wear is depicted in FIGURE 26.



FIGURE 26

- Lubricate round replacement rubber lock with water. DO NOT use oil. Install rubber lock into hole in tooth retention slot. FIGURE 27

NOTE: A flat type locking device installs around the tooth retention slot.

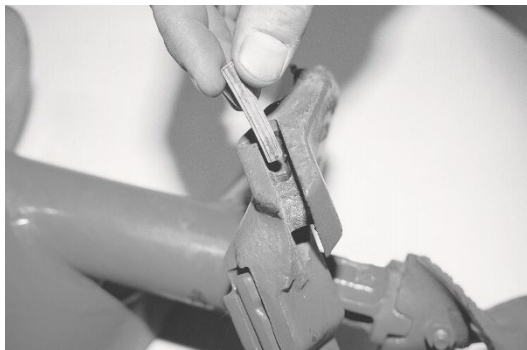

FIGURE 27

- Install replacement tooth into tooth retention slot by striking cutting edge of tooth with hammer. Use a smooth movement and wood block to protect tooth cutting edge from damage.

WARNING

- DO NOT strike any replacement tooth directly with a steel hammer. Use wood block to cushion blow.
- Doing so can create flying steel chips and other debris resulting in property damage and/or personal injury.
- Caution all onlookers to remain clear of area when performing auger maintenance.

- Determine replacement tooth is properly seated within tooth retention slot of casting. If excessive casting wear is present, tooth will not seat properly allowing it to become loose and fall out.

12 SERVICE/REPAIR INSTRUCTIONS



The following information is intended for non-scheduled service/repair situations when specific issues arise affecting Auger performance. Information is for reference only and is not intended to be all inclusive.

- Use factory approved replacement parts/accessories only for servicing/repair purposes.

WARNING

- Operating Auger utilizing components not meeting minimum operational standards can result in property damage and/or personal injury.

- All service/repairs not described in this operator manual must be done by a dedicated service center following a specific service/repair manual.
- STOP Auger BEFORE performing service and repair per STOPPING AUGER in OPERATING INSTRUCTIONS section of Operator's Manual.
- All engine service/repairs should be done according to contents of engine manufacturer material.

NOTE: The principal difference between the BRPA265H and BRPA270H Augers is the drive shaft configuration. The BRPA265H uses a 1-3/8 inch (35 mm) hexagon and the BRPA270H uses a 7/8 inch (22 mm) square driveshaft. All other components are the same. FIGURE 28



FIGURE 28

PRESSURE RELIEF VALVE SERVICING

Pressure relief valve is located on transmission cover top surface to relieve excess pressure in transmission due to heat rise. If valve becomes plugged, the following problems can occur:

- Transmission output driveshaft oil seal can push out of case, causing loss of transmission oil.
- Gasket separating transmission cover and case can push out, causing loss of transmission oil.

- To minimize issues, clean pressure relief valve with safety type solvent when replacing transmission oil seal or centrifugal clutch rotor and shoe assembly.

DANGER

- Use safety type solvent.
- DO NOT use thinner, benzene, or other volatile solvents that will attack rubber/plastic components when cleaning Auger.
- Provide adequate ventilation.
- DO NOT smoke while using cleaning solvents.
- DO NOT use solvents with engine running or if it is hot.
- Allow ample time for engine to cool BEFORE using solvents.
- An ignition source in close proximity to hot engine can be the source of an explosion, resulting in property damage and/or personal injury.

TRANSMISSION OIL SEAL REMOVAL & INSTALLATION

The Auger utilizes a fully enclosed, double reduction transmission for multiplying/transmitting engine torque to auger bit. Oil provides lubrication and heat dissipation for bearings, gears and clutch assembly.

Oil leakage between transmission output driveshaft and oil seal results from the following problems:

- Oil seal is worn due to extended operation.
- Inner sealing lip of oil seal is cut or nicked due to admission of foreign material or some sharp, abrasive object.
- Replacement oil seal was incorrectly installed in transmission.

IMPORTANT: In all above cases, a replacement oil seal must be correctly installed to prevent loss of transmission oil. The oil seal specified is an industry interchange standard and can usually be obtained from local supply sources.

Tools Required:

- 1 each, small, adjustable wrench
- 2 each, 1/2 inch (13 mm) wrenches
- 1 each, torque wrench 600 inch pound (68 N.m.) capacity with 1/2 inch (13 mm) and 15/16 inch (23.8 mm) sockets or,
- 1 each, torque wrench, 840 inch pounds (95 N.m.) capacity with 1/2 inch (13 mm) and 1-7/16 inch (36.5 mm) sockets
- 1 each, 1/2 inch (13 mm) drive socket wrench with 15/16 inch (23.8 mm) socket or,
- 1 each, 1/2 inch (13 mm) drive socket wrench with 1-7/16 inch (36.5 mm) socket
- 1 each, plastic hammer
- 1 each, three jaw gear puller
- 1 each, PN 345-7010 Service Tool
- 1 each, shop press

Parts Required:

- 1 each, PN 310-0101 transmission gasket
- 1 each, PN 471820 National® oil seal or industry equivalent
- 1 each, PN 15 alloy Woodruff key (if required)
- 1 each, PN 332-0350 large spur gear (if required)
- 1 each, PN 330H-0330 final driveshaft (if required)
- 1 each, PN 343H-0330 final driveshaft (if required)
- 2 each, PN 08125 bearing cones (if required)
- 1 each, container of Barium or Lithium based, lubricating grease
- 1 each, container of bearing/shaft locking grade, anaerobic adhesive/sealant
- 1 each, container of wheel bearing grease
- 1 each, PN 999-11 transmission and engine oil or equivalent.

NOTE: Oil seal removal and installation will require level working platform of sufficient size and appropriate height. As an alternative, transmission output driveshaft assembly can be securely mounted in suitable bench vise.

1. Drain fuel from fuel tank into a UL, CSA or UN marked, European ADR regulation approved fuel container and oil from transmission. If re-use is not possible, disposal must be carried out according to international and local environmental standards.

! DANGER

- **DO NOT** smoke near fuel tank.
- **DO NOT** fill fuel tank with engine running or if it is hot.
- **Allow ample time between each refueling for engine to cool.**
- **An ignition source in close proximity to fuel tank can be the source of an explosion, resulting in property damage and/or personal injury.**
- **Consult material supplied by engine manufacturer for information relative to proper fueling procedures.**

2. Remove transmission assembly bolts. Use plastic hammer to split/separate transmission cover and case. **DO NOT** damage alignment dowel pins. Temporarily store engine/transmission cover assembly in upright position in suitable location.
3. Remove clutch drum, primary gear/pinion gear assembly from transmission case.

! WARNING

- **DO NOT** perform service and/or repair related functions with Auger mounted to 999 Series Display Stands.
- **Stands are not designed and/or intended for these functions.**
- **Such use can result in property damage and/or personal injury.**

4. Clean transmission case with safety type solvent.

! DANGER

- **Use safety type solvent.**
- **DO NOT** use thinner, benzene, or other volatile solvents that will attack rubber/plastic components when cleaning Auger.
- **Provide adequate ventilation.**
- **DO NOT** smoke while using cleaning solvents.
- **DO NOT** use solvents with engine running or if it is hot.
- **Allow ample time for engine to cool BEFORE** using solvents.
- **An ignition source in close proximity to hot engine can be the source of an explosion, resulting in property damage and/or personal injury.**

5. Remove self-locking nut and flat washer. FIGURE 29

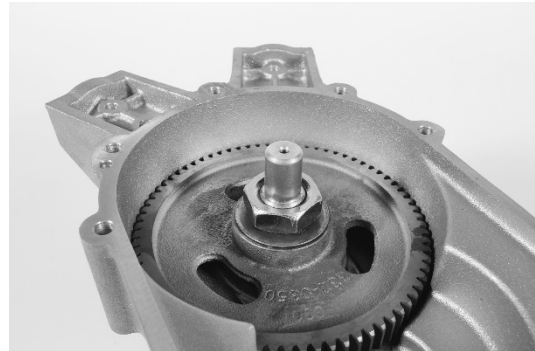

FIGURE 29

6. Using gear puller, remove large spur gear from driveshaft. FIGURE 30



FIGURE 30

7. Remove Woodruff key and Nilos ring.
8. Using shop press/suitable blocking, support transmission case driveshaft area to prevent damage. As alternative, wood blocks and plastic hammer can be used. FIGURE 31

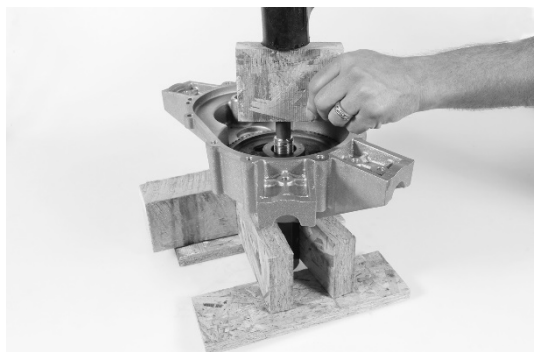

FIGURE 31



DANGER

- Wear safety eyewear and other safety apparel appropriate for the job application and/or job site environment.
- Bearing replacement process can create flying steel chips and/or other debris.
- Caution all onlookers regarding the possibility of and/or to remain clear of flying debris.
- Improper safety procedures can result in property damage and/or personal injury.

9. Press output driveshaft out of transmission through bearing in transmission case. Oil seal should also press out at this time.
10. Remove bearing cone from driveshaft. Inspect driveshaft for chipping and/or cracking around Woodruff key area. If any damage is evident, replace driveshaft.
11. Inspect driveshaft in location where inner portion of oil seal contacts shaft for concentricity, scratches, chips or other imperfections. If depth of any groove cut into driveshaft is greater than .010 inch (0.25 mm), replace driveshaft.

NOTE: Unless inner sealing member of replacement oil seal turns on a concentric, smooth surface, oil will continue to leak.

12. Inspect replacement oil seal area where driveshaft rotates within seal for scratches, chips or other imperfections which can cause oil to leak past seal. DO NOT use seal if any imperfections/damage is evident.
13. Pack cavity between inner and outer sealing members with Barium or Lithium based lubricating grease to minimize possibility of dry oil seal rotating on dry driveshaft during first few minutes of operation. FIGURE 32



FIGURE 32

NOTE: LUBRIPLATE 105 is an approved lubricant.

14. Inspect transmission case oil seal cavity for signs of galling or shape distortion. Coat oil seal outside diameter with bearing/shaft, locking grade, anaerobic adhesive/sealant to help retain in position.
15. Slide oil seal over circular spacer of driveshaft with circular, twisting motion. The crimped side of oil seal faces away and opposite threaded end of driveshaft. DO NOT cut or nick oil sealing lips when installing seal.
16. Clean and inspect both bearing cones. Replace if excessive wear is evident. Repack both bearings with a suitable wheel bearing grease. Reinstall lower bearing cone on driveshaft against spacer.
17. Position transmission case on shop press with bottom of case facing up. Make sure case is not supported on any alignment dowel pins. Use Service Tool to press oil seal/driveshaft assembly into transmission case until firmly seated against machined shoulder. FIGURE 33



FIGURE 33

IMPORTANT: Cocking seal in the case contributes to seal failure. The service tool has approximately a 2.431 inch (61.7 mm) outside diameter. The inside diameter of tool is approximately 2-1/4 inch (57.2 mm). Apply face of service tool to the crimped bead of the oil seal. Too much pressure too close to center of the seal will distort or damage it.

18. If an arbor press is not available, tap oil seal into place with thin, wood block and plastic hammer. Position seal against machined shoulder of transmission case with bore at right angles to shaft. FIGURE 34

IMPORTANT: Keep blows to outside edge of oil seal to prevent damage. DO NOT hit oil seal with direct hammer blows under any circumstances.

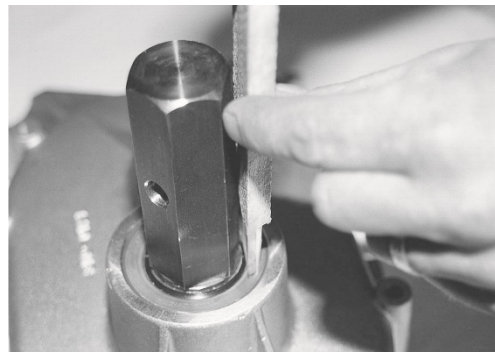

FIGURE 34

19. Reinstall upper bearing cone, Nilos ring and Woodruff key on driveshaft. Coat Woodruff key area of driveshaft with light oil, Barium or Lithium based lubricant.
20. Reinstall large spur gear and flat washer.
21. Apply small amount of anaerobic adhesive/sealant to protruding threads of driveshaft.
22. Torque 1-1/4 inch (31.8 mm) self-locking nut to 60-70 foot pounds (81-95 N.m.). Determine flat washer is tight against large spur gear and is seated against Nilos ring. If not fully seated, use thin wooden block and plastic hammer to tap gear down into place. DO NOT, under any circumstances, hit large spur gear with steel hammer.
23. Tap both ends of driveshaft with plastic hammer to help set bearings. Loosen 1-1/4 inch (31.8 mm) self-locking nut and retorquer to 60 foot pounds (81 N.m.). Recheck to determine flat washer is tight against large spur gear. Tap both ends of driveshaft with plastic hammer to help set bearings.
24. Attach torque wrench and 1-7/16 inch (36.5 mm) socket to 1-1/4 inch (31.8 mm) nut and rotate slowly to a maximum bearing drag of 30 INCH POUNDS (3.4 N.m.). This value should allow a MAXIMUM .003 inch (0.076 mm) of freeplay in the bearings. A greater amount of bearing drag will significantly decrease load capacity of bearings and contribute to premature bearing failure. If bearing value is less than or greater than the 30 inch pound (3.4 N.m.) value, readjust self-locking nut torque value to produce desired result. FIGURE 35

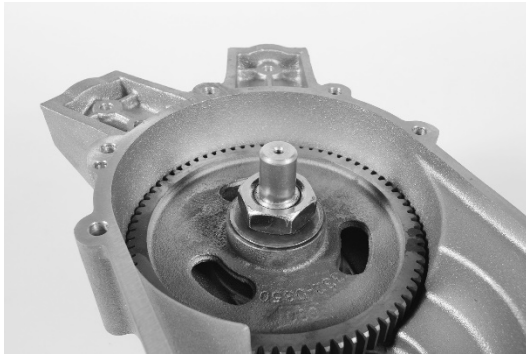

FIGURE 35

IMPORTANT: Flat washer must be tight against large spur gear plus, gear tight against Nilos ring to prevent driveshaft freeplay that exceeds allowable limit.

IMPORTANT: The precision machining tolerance between driveshaft diameter and large spur gear inside diameter can cause binding during assembly. Binding can prevent gear from firmly seating against Nilos ring and cause excessive driveshaft freeplay.

25. Reinstall primary gear and pinion assembly. If existing transmission gasket is damaged, replace. Realign transmission dowel pins when reinstalling engine/cover assembly. Torque all fasteners to 20 foot pounds (27 N.m.) in an "X" sequence.

IMPORTANT: Use of transmission gasket is required to provide adequate clearance. DO NOT substitute silicon material or gasket adhesive for factory approved gasket.

26. Rotate transmission output driveshaft and check for excessive noise and/or binding. If excessive noise and/or binding is evident, disassemble transmission and investigate for probable causes. Reassemble and retorque bolts to specified amount. Recheck for excessive noise and/or binding.
27. Refill transmission with oil and engine fuel tank with fuel to appropriate levels.

CENTRIFUGAL CLUTCH ROTOR/SHOE ASSEMBLY REMOVAL & INSTALLATION

The Auger utilizes an all metal centrifugal clutch rotor and shoe assembly that expands with engine RPM to engage clutch drum and transfer torque. The clutch rotor and shoe assembly is mounted to the engine crankshaft. Clutch assembly replacement symptoms include the following:

- a) Excessive clutch slippage and auger stalling at full, governed engine speed.
- b) Partial clutch engagement (and resulting auger rotation) at specified engine idle speed.

To replace clutch assembly, proceed as follows:

Tools Required:

- 2 each, 1/2 inch (13 mm) wrenches
- 1 each, three jaw gear puller (if required)
- 1 each, plastic hammer
- 1 each, torque wrench, 240 inch pound (27 N.m.) capacity with 1/2 inch (13 mm) socket
- 1 each, 1 inch (25.4 cm) capacity micrometer
- 1 each, feeler gauge set
- 1 each, 3/16 inch (4.7 mm) Allen wrench
- 1 each, 1/8 inch (3.2 mm), long handle type Allen wrench

Parts Required:

- 1 each, PN 3516 clutch drum/pinion assembly
- 1 each, PN 330H-0175 rotor/shoe assembly (units with Honda engine)
- 1 each, PN 310-0101 transmission gasket (if required)
- 1 each, PN 6 alloy Woodruff key (if required)
- 1 each, container of high temperature, anti-seize compound
- 1 each, container of wicking grade, anaerobic adhesive/sealant

NOTE: Centrifugal clutch rotor/shoe assembly removal and installation will require a level working platform of sufficient size and appropriate height.

1. Drain fuel from fuel tank into a UL, CSA or UN marked, European ADR regulation approved fuel container, oil from transmission and oil from engine. If re-use is not possible, disposal must be carried out according to international and local environmental standards.



DANGER

- DO NOT smoke near fuel tank.
- DO NOT fill fuel tank with engine running or if it is hot.
- Allow ample time between each refueling for engine to cool.
- An ignition source in close proximity to fuel tank can be the source of an explosion, resulting in property damage and/or personal injury.
- Consult material supplied by engine manufacturer for information relative to proper fueling procedures.

2. Remove transmission assembly bolts. Use plastic hammer to split/separate transmission cover and case. DO NOT damage alignment dowel pins. Temporarily store transmission case assembly in upright position in suitable location.

NOTE: Remove primary gear/pinion gear assembly if attached to transmission cover when case and cover are split apart.

3. Clean transmission cover with safety type solvent.



DANGER

- Use safety type solvent.
- DO NOT use thinner, benzene, or other volatile solvents that will attack rubber/plastic components when cleaning Auger.
- Provide adequate ventilation.
- DO NOT smoke while using cleaning solvents.
- DO NOT use solvents with engine running or if it is hot.
- Allow ample time for engine to cool BEFORE using solvents.
- An ignition source in close proximity to hot engine can be the source of an explosion, resulting in property damage and/or personal injury.

4. Using 3/16 inch (4.7 mm) Allen wrench, remove access screw from side of transmission cover. FIGURE 36

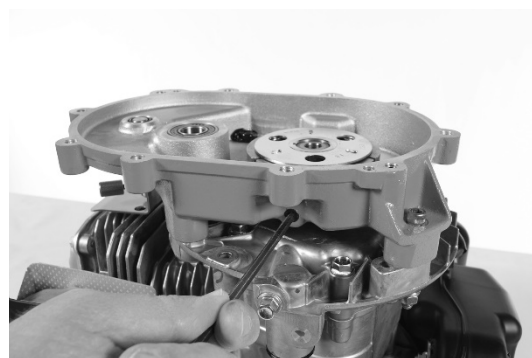

FIGURE 36

5. Using 1/8 inch (3.2 mm) Allen wrench, loosen two set screws retaining rotor/shoe assembly to engine crankshaft. FIGURE 37

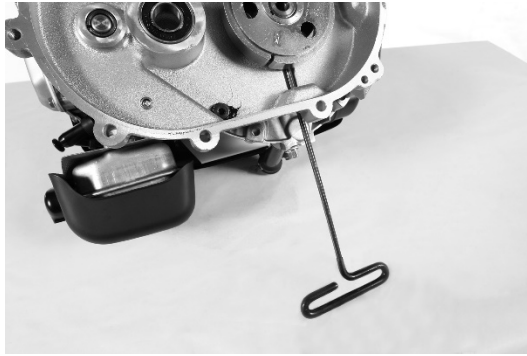

FIGURE 37

- IMPORTANT:** End of engine crankshaft is set .030 (0.76 mm) below top edge of clutch rotor/shoe assembly hub. FIGURE 39



FIGURE 39

6. Using gear puller, remove clutch rotor/shoe assembly. FIGURE 38

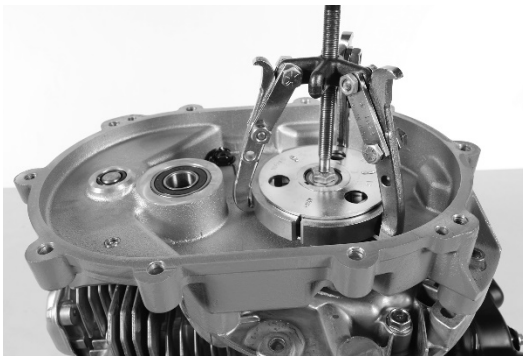

FIGURE 38

10. Apply wicking grade anaerobic adhesive to Allen screw to eliminate movement during Auger operation. Using 3/16 inch (4.7 mm) Allen wrench, re-install access screw in transmission cover side. FIGURE 40



FIGURE 40

7. Inspect engine crankshaft and Woodruff key for signs of cracks and/or other damage. Replace key if wear and/or elongation are visible. Measure engine crankshaft with micrometer. Minimum allowable crankshaft diameter is .996 inch (25.3 mm). Maximum allowable TIR limit in gear pinion journal area of crankshaft is .003 inch (0.076 mm), relative to crankshaft. If crankshaft assembly is not within defined limits, replace.

8. Clean surface of crankshaft with safety type solvent.

⚠ DANGER 

- Use safety type solvent.
- **DO NOT use thinner, benzene, or other volatile solvents that will attack rubber/plastic components when cleaning Auger.**
- Provide adequate ventilation.
- **DO NOT smoke while using cleaning solvents.**
- **DO NOT use solvents with engine running or if it is hot.**
- Allow ample time for engine to cool **BEFORE** using solvents.
- **An ignition source in close proximity to hot engine can be the source of an explosion, resulting in property damage and/or personal injury.**

9. Install replacement clutch rotor/shoe assembly on engine crankshaft with hub, including two set screws, toward crankcase. Tighten with 1/8 inch (13 mm) Allen wrench. FIGURE 39

11. Apply small amount of high temperature, anti-seize compound to pinion gear journal area of transmission case output driveshaft. Install replacement clutch drum/pinion assembly on transmission case output driveshaft.
12. Reinstall primary gear/pinion assembly. If existing transmission gasket is damaged, replace. Realign transmission dowel pins when reinstalling engine and cover assembly. Torque all fasteners to 20 pound feet (27 N.m.) in an "X" sequence.
- IMPORTANT:** Use of transmission gasket is required to provide adequate clearance. DO NOT substitute silicon material or gasket adhesive for factory approved gasket.
13. Rotate transmission output driveshaft and check for excessive noise and/or binding. If excessive noise and/or binding is evident, disassemble transmission and investigate for probable causes. Reassemble and retorqued bolts to specified amount. Recheck for excessive noise and/or binding.
14. Refill transmission, engine fuel tank and crank case with appropriate fluids to proper levels.

ENGINE SERVICE

Consult applicable material supplied by engine manufacturer for specific service and maintenance information regarding:

1. muffler
2. spark plug
3. air filter
4. carburetor adjustment
5. maintenance schedule
6. engine oil change
7. troubleshooting
8. short and long term storage

Keep this information stored with Operator Manual for Auger so it will always be available for use when engine requires service or maintenance.

Under Title 13 if the California Code of Regulations, the California Air Resource Board (CARB) has identified several important engine service related subjects. The material supplied by specific engine manufacturer will include the following:

1. statement of compliance
2. engine oil recommendations
3. engine fuel recommendations
4. maintenance information
5. other information as required by (CARB)
6. emission component warranty statement

If you have any question regarding emission components, warranty rights and responsibilities for a specific engine used on Auger, contact Customer Service Department for specific information. There is no charge for this service.

13 TROUBLESHOOTING

NOTE: If troubleshooting information does not correct situation, all maintenance/repairs not described in this operator manual must be done by a dedicated service center following a specific service/repair manual.

ENGINE WILL NOT START

Possible Cause	Correction
Fuel valve in off position.	Turn fuel valve to on position.
Ignition cut-off switch (if equipped) improperly adjusted.	Adjust throttle cable.
Incorrect carburetor adjustment.	See engine manufacturer supplied information.
Ignition wire to spark plug loose or disconnected.	Reconnect.
Fuel supply exhausted.	Refill fuel tank.

ENGINE LOSES POWER

Possible Cause	Correction
Incorrect carburetor adjustment.	See engine manufacturer supplied information.
Water in fuel supply.	Drain and replace fuel.
Plugged engine exhaust ports.	See engine manufacturer supplied information.
Dirty spark plug.	See engine manufacturer supplied information.
Incorrect throttle control/cable adjustment.	See MACHINE SET-UP this manual.
Gasoline tank breather vent closed (if so equipped).	Open vent.
Dirty air filter.	See engine manufacturer supplied information.

ENGINE OVERHEATS

Possible Cause	Correction
Incorrect carburetor adjustment.	See engine manufacturer supplied information.
Cooling fins clogged with debris.	Remove engine blower housing and clean cooling fins.

AUGER LACKS POWER

Possible Cause	Correction
Incorrect transmission oil level.	See FILLING AUGER WITH TRANSMISSION OIL in MACHINE SET-UP this manual.
Centrifugal clutch assembly worn.	Replace.
Incorrect throttle control/cable adjustment.	See MACHINE SET-UP this manual.

AUGER BIT ROTATES AT IDLE SPEED

Possible Cause	Correction
Incorrect throttle control/cable adjustment does not permit proper engine idle speed.	See MACHINE SET-UP this manual.
Centrifugal clutch worn.	Replace.
Incorrect engine idle speed.	See MACHINE SET-UP this manual and/or engine manufacturer supplied information.

14 STORAGE

TEMPORARY STORAGE (On Job Site)

Auger can be temporarily stored on job site by one of three acceptable methods. Method chosen by operator is based on personal preference and/or job site conditions.

1. In all three storage methods, STOP Auger per STOPPING AUGER in OPERATING INSTRUCTIONS section of this manual.
 - a. Dig shallow hole and leave Auger connected to auger bit. FIGURE 41

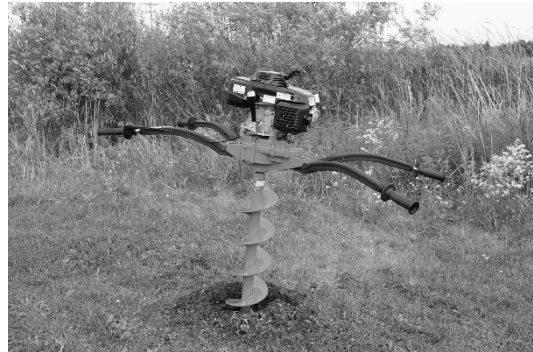

FIGURE 41

- b. Disconnect Auger from auger bit and/or auger bit extension and store in level configuration. FIGURE 42



FIGURE 42

- c. Store Auger connected only to lead auger bit with engine spark plug facing upward to minimize potential for crankcase oil entering combustion chamber and causing hydraulic lock up. FIGURE 43



FIGURE 43

2. Protect operator handles from external sources of damage. DO NOT allow handles to contact auger bits, shovels, or other sharp/abrasive objects during transit whether stacked or thrown against handles. DO NOT drag Auger with handle or throttle grips contacting ground. Damage can result.



WARNING

- DO NOT drop or impact Auger against ground.
- Action can damage twist grip throttle control, engine and result in property damage and/or personal injury.



DANGER

- **DO NOT store Auger with engine operating.**
- **Improper storage methods can result in property damage and/or personal injury.**



WARNING

- **When storing Auger using methods a, b or c, turn fuel tank on/off valve to off position.**
- **Action prevents fuel flooding carburetor and/or entering combustion chamber and/or impacting the environment.**
- **Not turning valve to off position can result in property damage and/or personal injury.**

LONG TERM STORAGE

Procedure for Auger long term storage will protect against effects of corrosion and damage. If Auger is not to be operated for a period of 30 days or more, proceed to store as follows:

1. STOP Auger per STOPPING AUGER in OPERATING INSTRUCTIONS section of this manual.



DANGER

- **DO NOT store Auger with engine operating.**
- **Improper storage methods can result in property damage and/or personal injury.**

2. Disconnect auger bit from Auger.
3. Drain transmission and refill with clean oil per CHANGING AUGER TRANSMISSION OIL in MAINTENANCE INSTRUCTIONS section of this manual.
4. Follow procedure as outlined in material supplied by engine manufacturer detailing long term storage of engine.
5. Clean all accumulated dirt and grease from Auger utilizing safety type solvent. Provide adequate ventilation and observe all applicable safety precautions for solvent.



DANGER



- **Use safety type solvent.**
- **DO NOT use thinner, benzene, or other volatile solvents that will attack rubber/plastic components when cleaning Auger.**
- **Provide adequate ventilation.**
- **DO NOT smoke while using cleaning solvents.**
- **DO NOT use solvents with engine running or if it is hot.**
- **Allow ample time for engine to cool BEFORE using solvents.**
- **An ignition source in close proximity to hot engine can be the source of an explosion, resulting in property damage and/or personal injury.**

6. Inspect all visible parts for wear, breakage or damage. Replace any part required to make necessary repair with factory approved parts only.
7. Apply light coat of protective grease to transmission driveshaft to prevent formation of rust.
8. Store Auger with operator handles level with ground to prevent transmission oil draining from breather vent and damaging surrounding environment and to minimize potential for crankcase oil entering combustion chamber and creating hydraulic lock up.
9. DO NOT allow handles to come in contact with augers, shovels, or other sharp and abrasive objects during storage to prevent damage.
10. Store Auger inside. If Auger must be stored outside, protect it and each auger with a suitable covering.

15 END OF LIFECYCLE



If the machine comes to the end of its lifecycle, destruction of the machine must be conducted according to international and local environmental regulations.



20195 South Diamond Lake Road, Suite 100 • Rogers, MN 55374
Toll-Free: 800-350-8739 • Website: braveproducts.com • Email: sales@braveproducts.com

Dear Valued Customer:

The Brave product you just purchased is built with the finest material and craftsmanship. Use this product properly and enjoy the benefits from its high performance. By purchasing a Brave product, you show a desire for quality and durability. Like all mechanical equipment this unit requires a due amount of care. Treat this unit like the high-quality piece of machinery it is. Neglect and improper handling may impair its performance.

Thoroughly read the instructions and understand the operation before using your product. Always contact Brave Product Support at 1-800-350-8739 prior to having any service or warranty work performed, as some services performed by parties other than Brave approved service centers may void this warranty. This limited warranty is in lieu of any other warranty expressed or implied, written or oral and Brave assumes no other responsibility or liability outside that expressed within this limited warranty.

Limited Warranty for Brave and Brave Pro Augers:

BRPA180H
BRP240HHD

BRA250H
BRPA265H
BRPA270H
BRP330HHD
BRP343HHD

BRPA325H

	Consumer Warranty Period	Commercial Warranty Period
Weldments	2 years from date of purchase by user	2 year from date of purchase by user
Gear Case	2 years from date of purchase by user	1 year from date of purchase by user
Wear Parts	In addition to the normal warranty, Brave shall warrant some normal wear items from defects in material or workmanship for a period of 30 days from the date of purchase by user. Normal wear items covered under this warranty are limited to: High impact wear related components such as V-belts, flails, flail rods and flail drums. High abrasion wear related parts such as augers, auger fighting, boring heads, multi-accessory attachments, tungsten carbide inserts and flexible ducts. Engine throttle control cable assemblies and related control devices. Centrifugal clutch components such as shoes, springs drum and rotor assembly. Routine maintenance items such as lubricants, clutch adjustments, tune ups are not covered under warranty.	
Engines, Motors, Pumps and Controls	The warranty of these main components and engine is covered under the terms and conditions as outlined by the component and engine manufactures warranty contained herein and is the sole responsibility of the component and engine manufacturer. Normal engine maintenance such as spark plugs, oil changes, air filters, adjustments, fuel system cleaning and obstruction due to build up is not covered by this Brave limited warranty.	

“Consumer use” means personal residential household use by a consumer. “Commercial use” means all other uses, including, but not limited to, use for commercial, income producing or rental purposes or when purchased by a business.

This limited warranty applies to the original purchaser of the equipment (verification of purchase, in the form of a receipt, is the responsibility of the buyer), is non-transferable, and covers parts and labor. Parts will be replaced or repaired at no charge, except when the equipment has failed due to lack of proper maintenance. If a part is no longer available, the part may be replaced with a similar part of equal function. Any misuse, abuse, alteration or improper installation or operations will void warranty. Determining whether a part is to be replaced or repaired is the sole decision of Brave. Brave will not provide for replacement of complete products due to defective parts. Any costs incurred due to replacement or repair of items outside of a Brave approved facility is the responsibility of the buyer and not covered under warranty. Transportation costs to and from service center and/or service calls are the responsibility of the customer.

This limited warranty specifically excludes the following; failure of parts due to damage caused by accident, fire, flood, windstorm, acts of God, applications not approved by Brave in writing, corrosion caused by chemicals, use of replacement parts which do not conform to manufacturer’s specifications, damage related to rodent and/or insect infestation and damage caused by vandalism. Additional exclusions: loss of running time, inconvenience, loss of income, or loss of use, including any implied warranty of merchantability of fitness for a specific use. Also, outdoor power equipment needs periodic parts and service to perform well, and this limited warranty does not cover instances when normal use has exhausted the life of a component or the engine.

This limited warranty does not cover any personal injury or damage to surrounding property caused by failure of any part, misuse or inability to use the product. Alteration of the product, including safety features, shall void this limited warranty.

Repair or replacement of parts does not extend the warranty period. This limited warranty gives you specific legal rights. You may also have other rights that vary by state. Please have model number, item number and serial number on hand prior to making a warranty claim or inquiry.



**Brave
Product Registration Form**

YOUR INFORMATION

Full Name:

Last First M.I.

Address:

Street Address Apartment/Unit #

City State ZIP Code

Home Phone:

**Alternate
Phone:**

Email

PURCHASED FROM

Company:

Address:

Street Address Apartment/Unit #

City State ZIP Code

MODEL INFORMATION

Purchase Date

Application Type

Homeowner Commercial Rental

Model (i.e. BRP240HHD)

Serial # (i.e. 123456)

Signature

Register your product online at www.braveproducts.com

BRAVE



**NO OIL IN
ENGINE AND TRANSMISSION**

エンジンオイルは入っていません。
必ず注油してから始動して下さい。

**VOR INBETRIEBNAHME
MOTORÖL AUFFÜLLEN.**

PAS D'HUILE DANS L'APPAREIL.

NO HAY ACEITE.

FORM:GEF4250301 v1.2

BRAVE



NÃO CONTEM ÓLEO.

未注油

GEEN OLIE AANWEZIG.

ยังไม่ได้ใส่น้ำมันหล่อลื่น

لا يوجد زيت بالجهاز

Do It Right!

Determine the Hole Digger model and consult the appropriate assembly section within the Operator Manual for the correct assembly procedure. Refer to the **MAGURA THROTTLE CONTROL MAINTENANCE PROGRAM** section in the Operator Manual for additional throttle control assembly and/or service information. All slack must be completely removed within the Magura throttle control to prevent inner cable damage. Failure to remove the slack will result in permanent damage to the inner cable. This damage will normally require complete replacement of the throttle cable assembly and is not covered by the terms of the product warranty. If you require assistance contact our Customer Service Department: 800.350.8739 Telefax: 1-866-779-9963.

Form: GEF4079901BR v1.1

BRAVE

Hagalo Correcto!

Determine el tipo de hoyo a escavar. Consulte la seccion apropiada de ensablaje en el Manual del Operador. Consulte el **PEDAL DE CONTROL PARA EL PROGRAMA DE MANTENIMIENTO** en el Manual del Operador, para informacion adicional sobre ensablaje o mantenimiento. Importante: Para evitar danos al cable interno del pedal todos los sujetadores del cable deben ser aflojados completamente. El no aflojar los sujetadores del cable resultara en dano permanente al cable interno. Para reparar este dano normalmente se requiere un completo reemplazo del cable del pedal, y no esta cubierto por la garantia en danos al producto. Si necesita ayuda, llame a nuestro Departamento de Servicio al Cliente: 800.350.8739. Telefax: 1-866-779-9963.

Form: GEF4079901BR v1.1

BRAVE

*Replacement Parts Diagram
BRPA265H & BRPA270H Auger
Equipped With Honda GXV160 Engine*

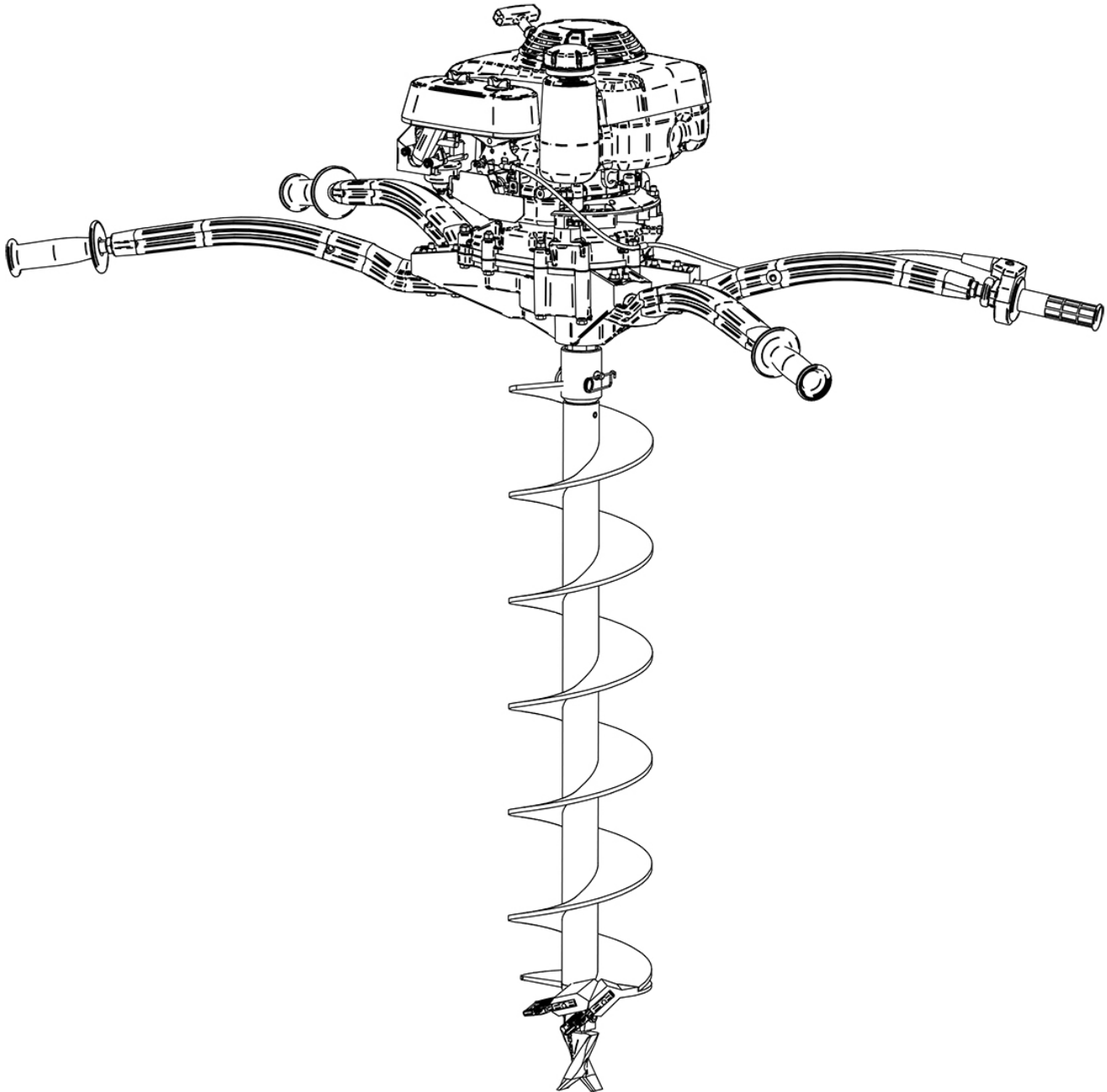

Replacement Parts Diagram Transmission Cover Assembly BRPA265H & BRPA270H Auger [Beginning with Serial Number 174809]

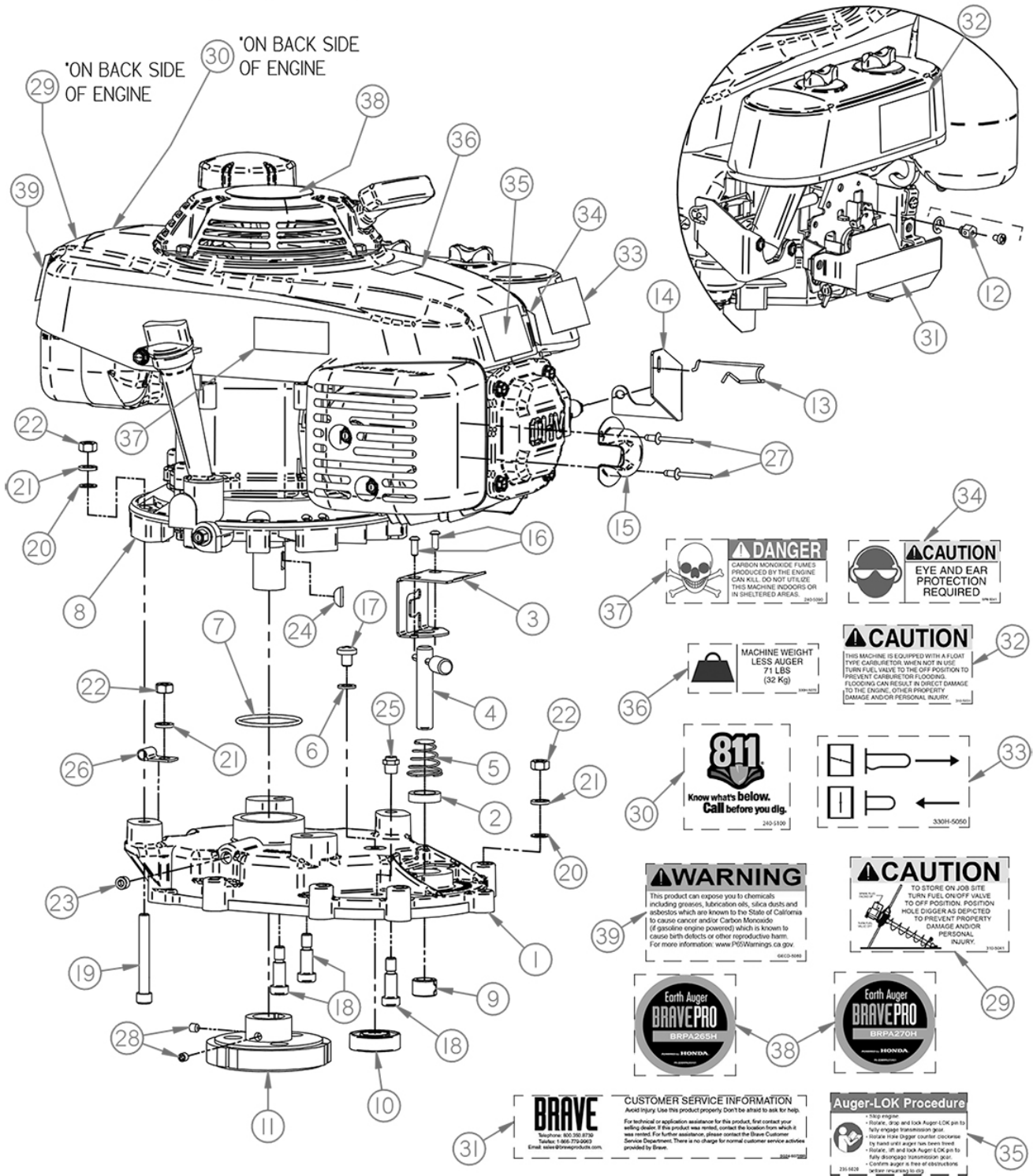

*Replacement Parts Diagram
Transmission Cover Assembly
BRPA265H & BRPA270H Auger
[Beginning with Serial Number 174809*

Reference Number	Part Number	Description	Quantity
1	332-0130A	Assembly, Cover, Transmission, (Includes Ref. 9 & 10)	1
2	471442	Seal, Oil	1
3	235-0230	Plate, Pin, Lock	1
4	235-0220	Assembly, Pin, Lock	1
5	235-0110	Spring, Pin, Lock	1
6	330H-0200	Washer, Nylon	1
7	330H-0020	Ring, O Type	1
8	GXV160UH2N5AH-BLK	Engine, Honda, GXV160	1
9	235-0140	Bushing, Spring-Type	1
10	6203-2RS-12	Bearing, Ball	1
11	330H-0175	Assembly, Rotor/Shoe, Clutch, (Includes Ref. 28)	1
12	330-0320	Assembly, Swivel	1
13	16611-ZG9-U80	Rod, Choke	1
14	17954-ZG9-U80	Bracket, Choke	1
15	330H-0040	Deflector, Exhaust, Gxv160	1
16	55030400	BHSCS, #10-24 X 1/2, ZY	2
17	37050300	PHMS, 5/16-18 X 3/8, ZY	1
18	62060601	Bolt, Shoulder, 3/8 X 3/4	3
19	60052000	SHCS, 5/16-18 X 2-1/2, ZY	1
20	AN-960-516L	Washer, Flat, 5/16, ZY	7
21	16050000	Washer, Lock, 5/16, ZY	8
22	18050000	Nut, Hex, 5/16-18, ZY	8
23	74020201	Plug, PTF, 1/8-27	1
24	6	Key, Woodruff, 5/32 X 5/8	1
25	5677	Valve, Relief	1
26	COV-0411	Clamp	1
27	46030100	Rivet, Pop, 3/16 X 1/8, SS	2
28	31040201	Screw, Set, 1/4-28 X 1/4, PF	2
29	310-5041	Decal, Storage	1
30	240-5100	Decal, 811	1
31	SG24-5072BR	Decal, Assistance	1
32	310-5031	Decal, Carb Off	1
33	330H-5050	Decal, Choke	1
34	SP8-5041	Decal, Caution, Eye/Ear	1
35	235-5020	Decal, Lock, Auger	1
36	330H-5070	Decal, Weight	1
37	240-5090	Decal, Danger	1
38	ZDBRPA265H01	Decal, BRPA265H, (Used on BRPA265H Only)	1
	ZDBRPA270H01	Decal, BRPA270H, (Used on BRPA270H Only)	1
39	GECD-5060	Decal, Warning, Prop 65	1

Replacement Parts Diagram Transmission Case Assembly BRPA265H & BRPA270H Auger [Beginning with Serial Number 174809

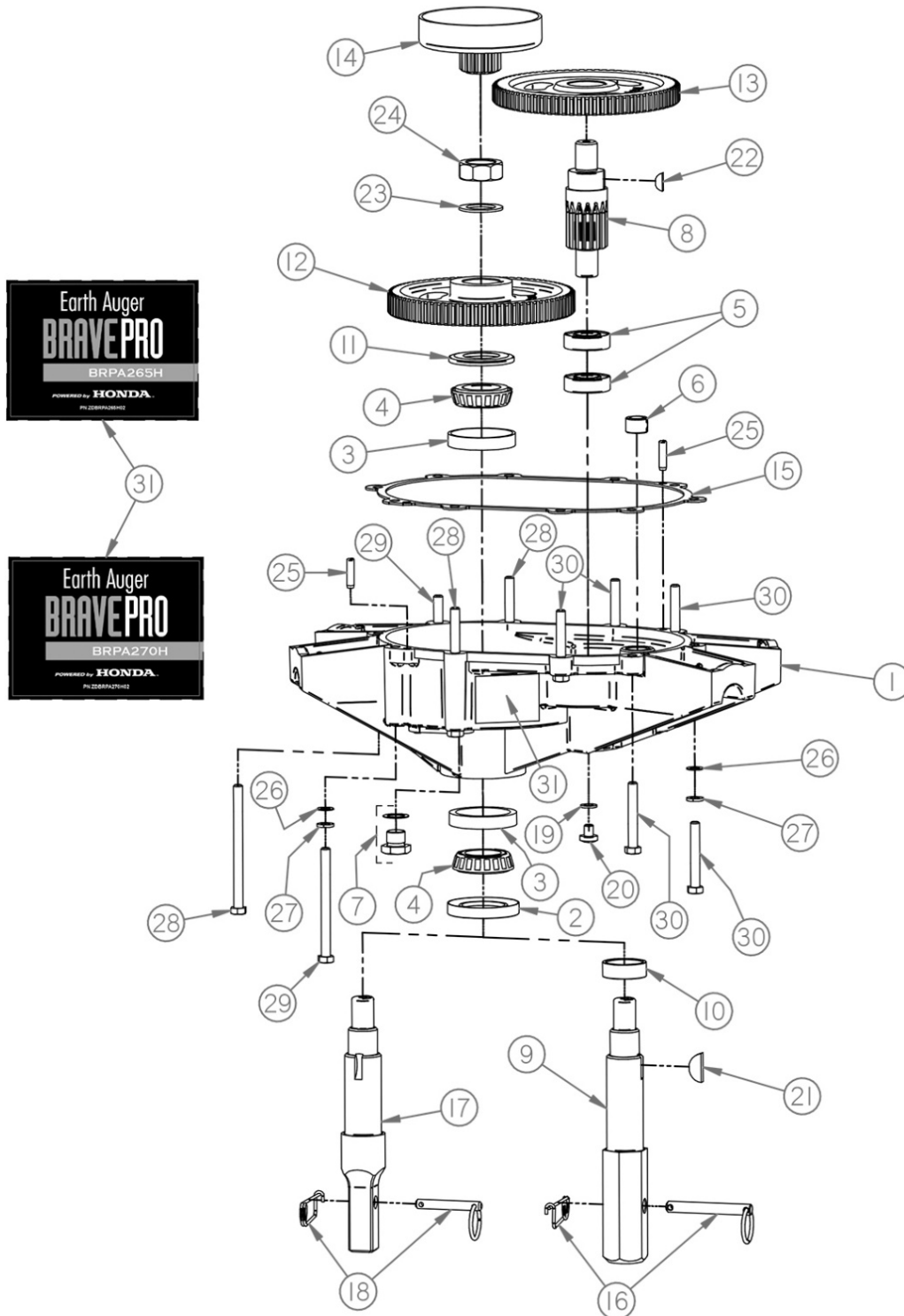

*Replacement Parts Diagram
Transmission Case Assembly
BRPA265H & BRPA270H Auger
[Beginning with Serial Number 174809*

Reference Number	Part Number	Description	Quantity
1	332-0120A	Assembly, Case, Transmission, (Includes Ref. 3, 5 & 6)	1
2	471820	Seal, Oil	1
3	08231	Cup, Bearing	2
4	08125G	Cone, Bearing	2
5	6203-2RS-12	Bearing, Ball	2
6	235-0140	Bushing, Spring-Type	1
7	50100800A	Plug, Drain, Oil, W/Gasket	1
8	332-0310	Gear, Pinion, Secondary	1
9	332-0330A	Shaft, Drive, 1.38HEX, (Used on BRPA265H, Includes Ref. 10)	1
10	332-0330-010	Bushing, Shaft, Drive	1
11	0812508231B-AV	Ring, Nilos	1
12	332-0350	Gear, Secondary	1
13	7034	Gear, Primary	1
14	3516	Drum, Clutch, W/Pinion	1
15	332-0100PAK2	Pak2, Gasket, Transmission	1
16	BR10628	Pak3, Pin, Auger, .375D	1
17	348-0330	Shaft, Drive, .88SQ, (Used on BRPA270H)	1
18	BR10627	Pak3, Pin, Auger, .312D	1
19	330H-0200	Washer, Nylon	1
20	37050300	PHMS, 5/16-18 X 3/8, ZY	1
21	15	Key, Woodruff, 1/4 X 1	1
22	6	Key, Woodruff, 5/32 X 5/8	1
23	85160000	Bushing, Machine, 1.0NR	1
24	40160001	Nut, Jam, Hex, 1-14, Z	1
25	51040800	Pin, Dowel, 1/4 X 1	2
26	AN-960-516L	Washer, Flat, 5/16, ZY	9
27	16050000	Washer, Lock, 5/16, ZY	10
28	15053400	HHCS, 5/16-18 X 4-1/4, ZY	3
29	15053000	HHCS, 5/16-18 X 3-3/4, ZY	2
30	15051800	HHCS, 5/16-18 X 2-1/4, ZY	5
31	ZDBRPA265H02	Decal, BRPA265H, (Used on BRPA265H Only)	1
	ZDBRPA270H02	Decal, BRPA270H, (Used on BRPA270H Only)	

*Replacement Parts Diagram
 Throttle Handle Assembly
 BRPA265H & BRPA270H Auger
 [Beginning with Serial Number 174809*

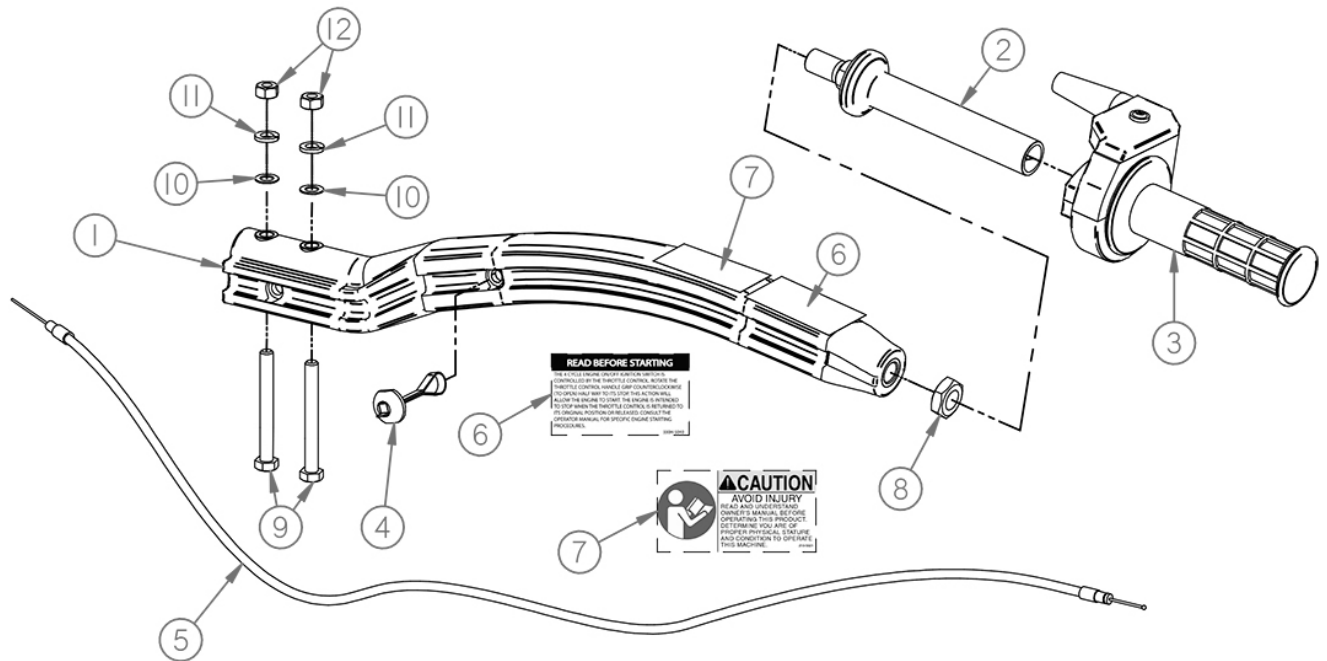

*Replacement Parts Diagram
 Operator Handle Assembly
 BRPA265H & BRPA270H Auger
 [Beginning with Serial Number 174809*

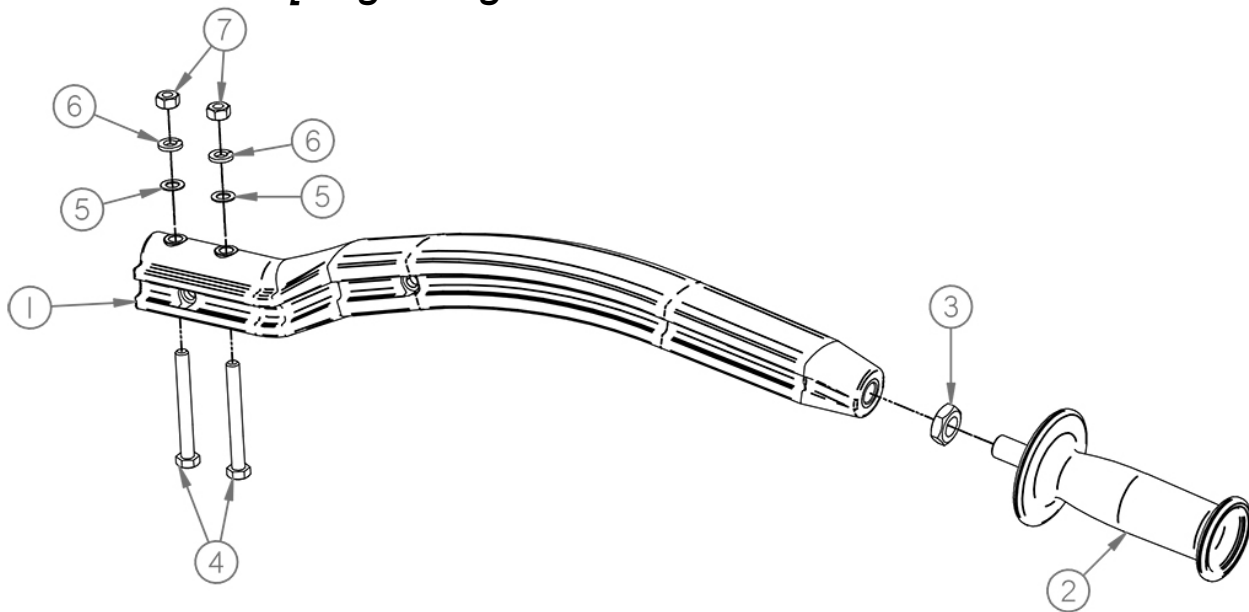

*Replacement Parts Diagram
Throttle Handle Assembly
BRPA265H & BRPA270H Auger
[Beginning with Serial Number 174809*

Reference Number	Part Number	Description	Quantity
1	235-0150	Handle, Throttle	1
2	235-0250	Grip, Handle, Throttle	1
3	310-0030	Assembly, Control, Throttle	1
4	235-0370	Tie, Cable, Throttle	1
5	310-0081PAK2	Pak2, Assy, Cable, Throttle	1
6	330H-5040	Decal, Ignition	1
7	210-5021	Decal, Caution, Avoid Injury	1
8	40090001	Nut, Jam, Hex, 9/16-18, ZY	1
9	15052200	HHCS, 5/16-18 X 2-3/4, ZY	2
10	AN-960-516L	Washer, Flat, 5/16, ZY	2
11	16050000	Washer, Lock, 5/16, ZY	2
12	18050000	Nut, Hex, 5/16-18, ZY	2

*Replacement Parts Diagram
Operator Handle Assembly
BRPA265H & BRPA270H Auger
[Beginning with Serial Number 174809*

Reference Number	Part Number	Description	Quantity
1	235-0090	Handle, Operator	1
2	235-0240	Grip, Handle, Operator	1
3	40090001	Nut, Jam, Hex, 9/16-18, ZY	1
4	15052200	HHCS, 5/16-18 X 2-3/4, ZY	2
5	AN-960-516L	Washer, Flat, 5/16, ZY	2
6	16050000	Washer, Lock, 5/16, ZY	2
7	18050000	Nut, Hex, 5/16-18, ZY	2

Replacement Parts Diagram
 PN: 310-0030Throttle Handle Assembly
 For Use With
 BRPA265H & BRPA270H Auger

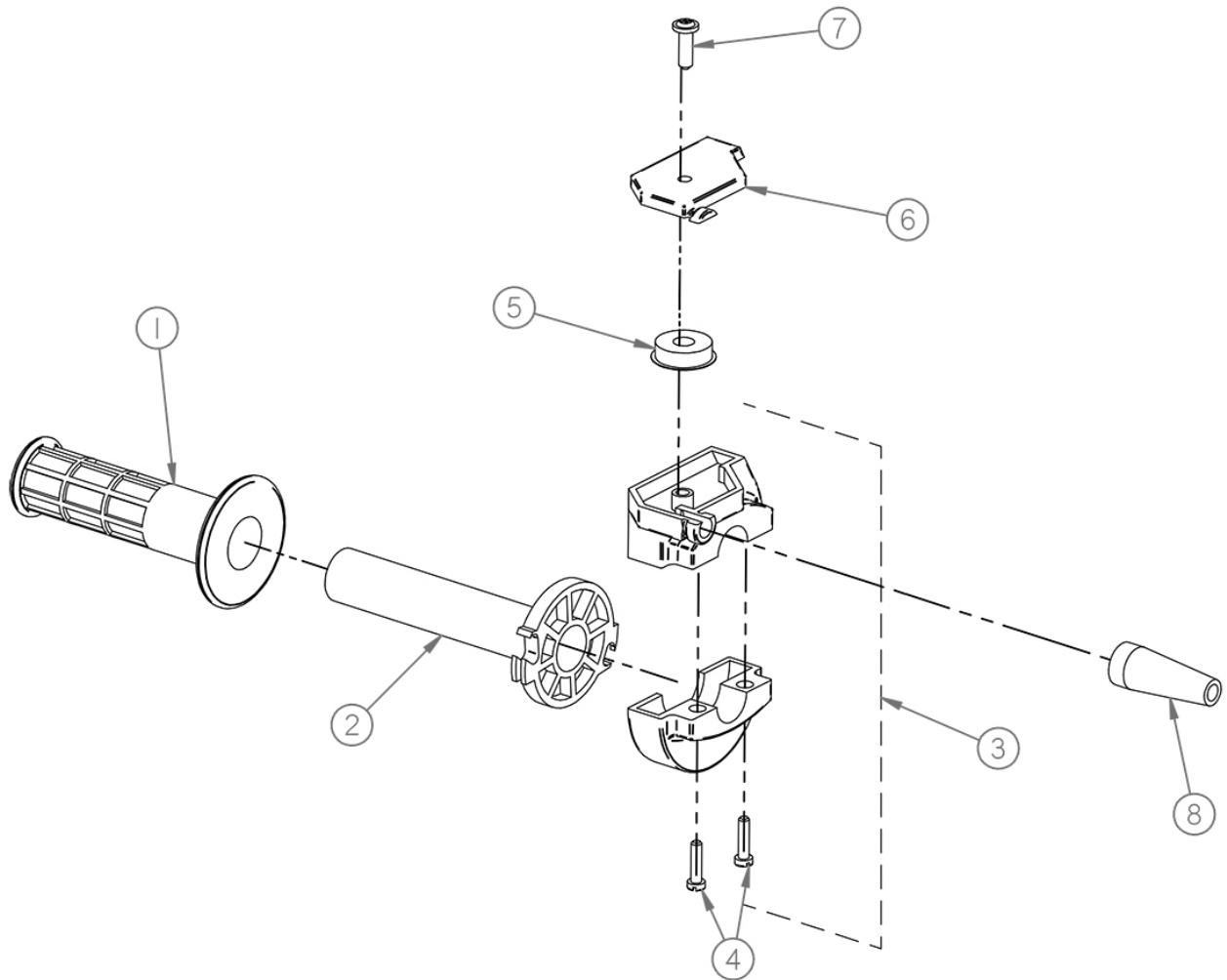

Reference Number	Part Number	Description	Quantity
1	310-0020-030	Grip, Throttle	1
2	310-0030-020-A	Tube, Throttle, W/Grip, (Includes Reference 1)	1
3	310-0030-010-A	Assembly, Body, W/Screws, (Includes Reference 4)	1
4	310-0030-040	Screw, Cheesehead, M5-.8 X 20	2
5	310-0030-070	Sheave, Roller	1
6	310-0030-060	Cover, Top	1
7	310-0030-050	Screw, Self-Tapping	1
8	310-0020-080	Boot, Rubber	1

*Replacement Parts Diagram
4 Inch Diameter Auger Bit
1-3/8 Inch Hexagon Drive Connection
For Use With BRPA265H Auger*

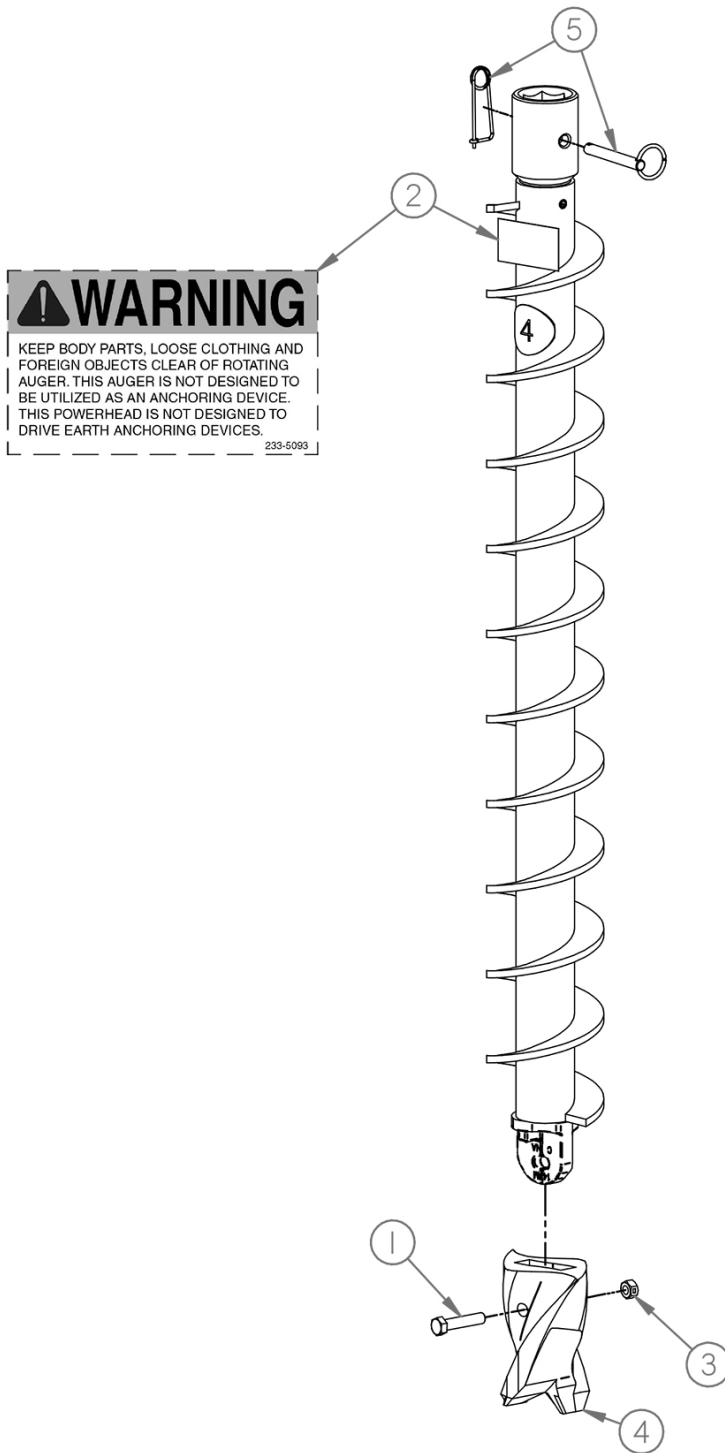

*Replacement Parts Diagram
4 Inch Diameter Auger Bit
1-3/8 Inch Hexagon Drive Connection
For Use With BRPA265H Auger*

Reference Number	Part Number	Description	Application	Quantity
1	15061400	HHCS, 3/8-16 X 1-3/4, ZY	BR10586	1
2	233-5093	Decal, Caution, Clear Rotating	All Augers	1
3	52060000	Nut, Lock, 2-Way, 3/8-16, ZY	BR10586	1
4	BR10625	Bit, Screw, Auger, (Includes Reference 1 & 3)	BR10586	1
5	BR10628	Pak3, Pin, Auger, .375D	BR10586	1

*Replacement Parts Diagram
 6 Thru 18 Inch Diameter Auger Bits
 1-3/8 Inch Hexagon Drive Connection
 For Use With BRPA265H Auger*

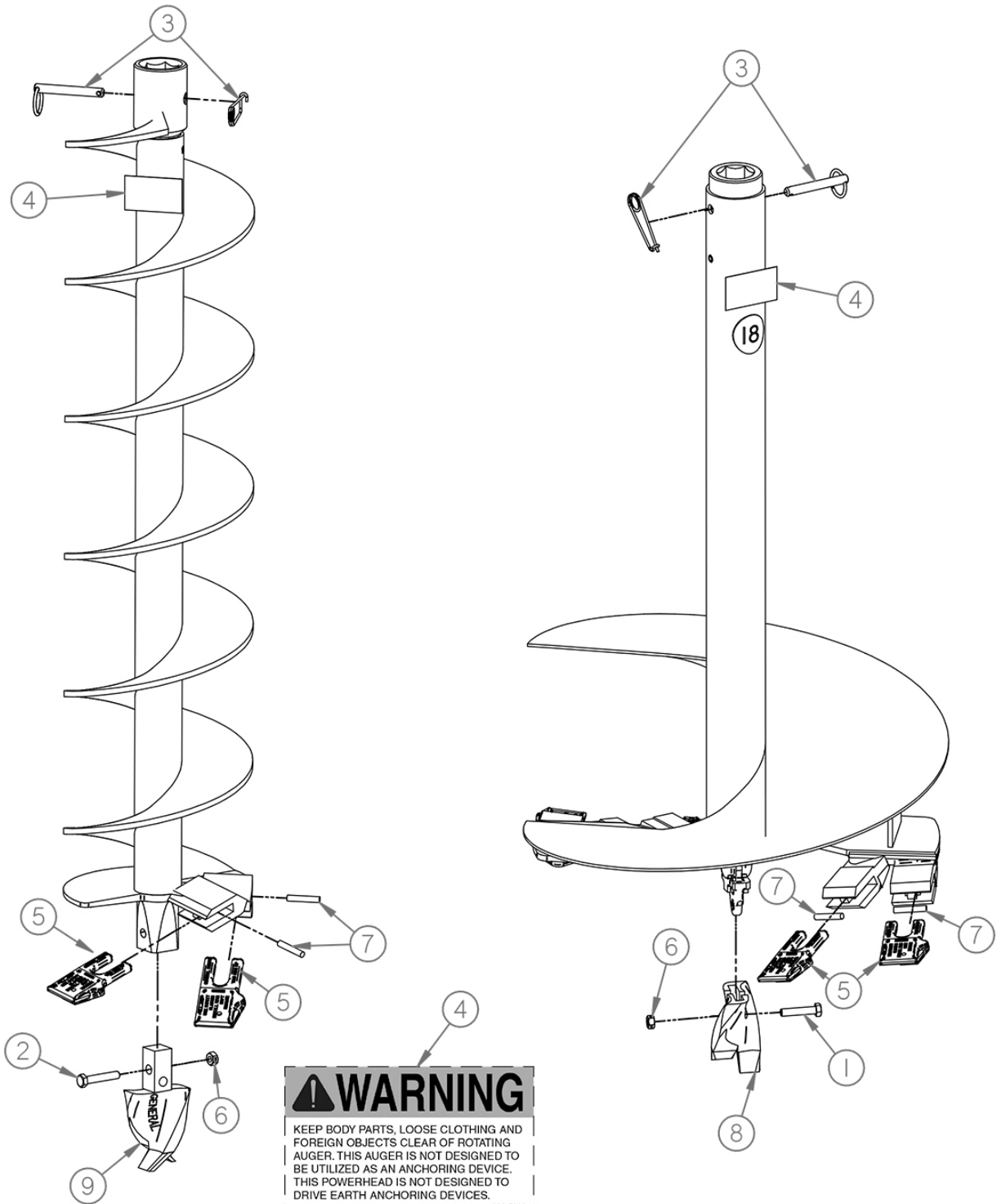

*Replacement Parts Diagram
 6 Thru 18 Inch Diameter Auger Bits
 1-3/8 Inch Hexagon Drive Connection
 For Use With BRPA265H Auger*

Reference Number	Part Number	Description	Application	Quantity
1	15051200	HHCS, 5/16-18 X 1-1/2, ZY	BR10591 Thru BR10593	1
2	15051400	HHCS, 5/16-18 X 1-3/4, ZY	BR10587 Thru BR10590	1
3	BR10628	Pak3, Pin, Auger, .375D	BR10587 Thru BR10590	1
4	233-5093	Decal, Caution, Clear Rotating	All Augers	1
5	BR10615	Pak7, Tooth, Dirt, Hardfaced, (Includes 7 Each PN: RL, Lock, Rubber)	BR10587 Thru BR10593	As Req.
6	52050000	Nut, Lock, 2-Way, 5/16-18, ZY	BR10587 Thru BR10593	1
7	RLPAK21	Pak21, Lock, Rubber	BR10587 Thru BR10593	As Req.
8	BR10619	Pak3, Bit, Screw, Auger, (Includes Ref. 1 & 6)	BR10591 Thru BR10593	1
9	BR10621	Pak3, Bit, Screw, Auger, (Includes Ref. 2 & 6)	BR10587 Thru BR10590	1

*Replacement Parts Diagram
4 Thru 12 Inch Diameter Auger Bits
7/8 Inch Square Drive Connection
For Use With BRPA270H Auger*

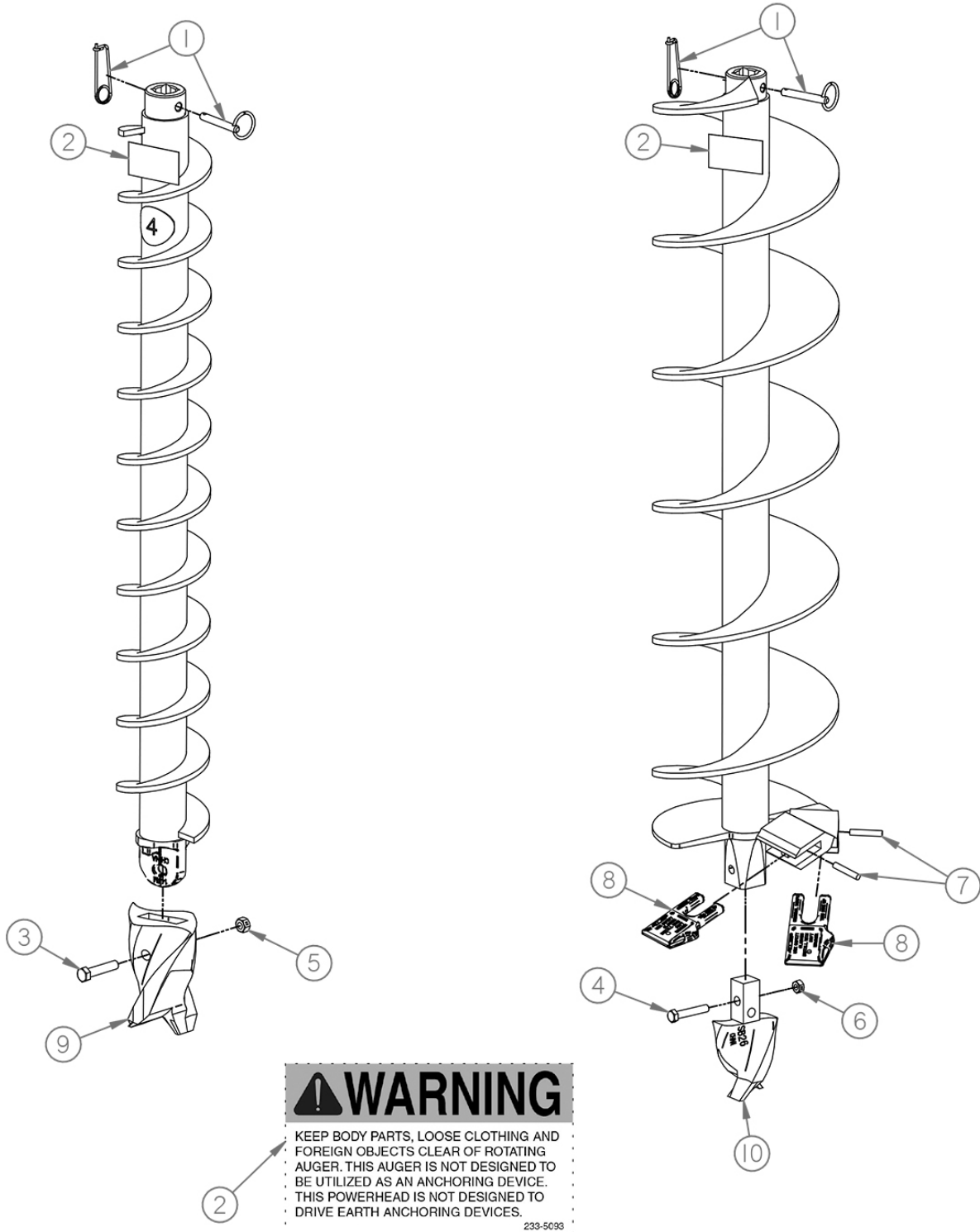

*Replacement Parts Diagram
 4 Thru 12 Inch Diameter Auger Bits
 7/8 Inch Square Drive Connection
 For Use With BRPA270H Auger*

Reference Number	Part Number	Description	Application	Quantity
1	BR10627	Pak3, Pin, Auger, .312D	BR10595 Thru BR10599	1
2	233-5093	Decal, Caution, Clear Rotating	All Augers	1
3	15061400	HHCS, 3/8-16 X 1-3/4, ZY	BR10595	1
4	15051400	HHCS, 5/16-18 X 1-3/4, ZY	BR10596 Thru BR10599	1
5	52060000	Nut, Lock, 2-Way, 3/8-16, ZY	BR10595	1
6	52050000	Nut, Lock, 2-Way, 5/16-18, ZY	BR10596 Thru BR10599	1
7	RLPAK21	Pak21, Lock, Rubber	BR10596 Thru BR10599	As Req.
8	BR10615	Pak7, Tooth, Dirt, Hardfaced, (Includes 7 Each PN: RL, Lock, Rubber)	BR10596 Thru BR10599	As Req.
9	BR10625	Bit, Screw, Auger, (Includes Ref. 3 & 5)	BR10595	1
10	BR10621	Pak3, Bit, Screw, Auger, (Includes Ref. 4 & 6)	BR10596 Thru BR10599	1

*Replacement Parts Diagram
14 Thru 18 Inch Diameter Auger Bits
7/8 Inch Square Drive Connection
For Use With BRPA270H Auger*

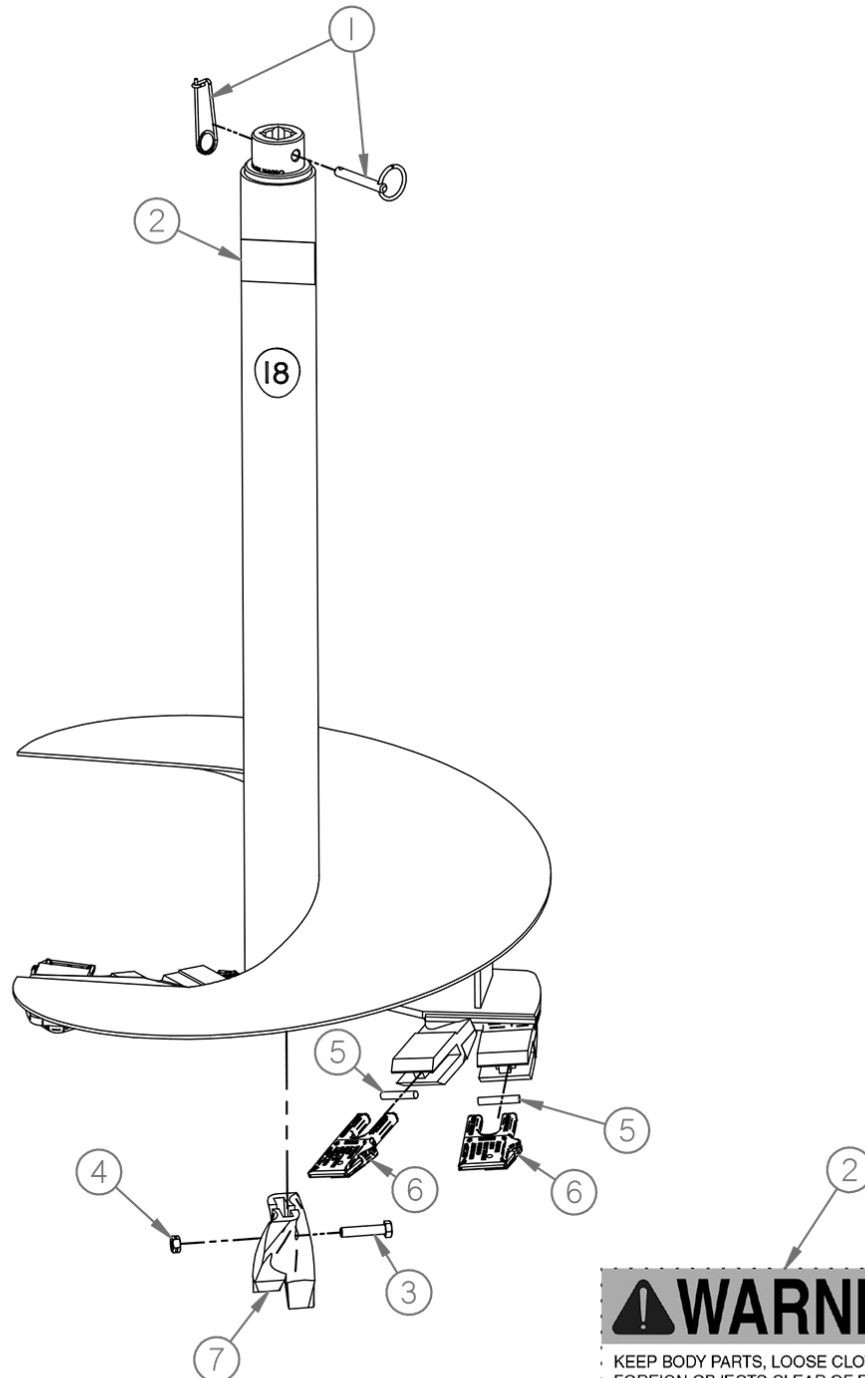

⚠ WARNING

KEEP BODY PARTS, LOOSE CLOTHING AND FOREIGN OBJECTS CLEAR OF ROTATING AUGER. THIS AUGER IS NOT DESIGNED TO BE UTILIZED AS AN ANCHORING DEVICE. THIS POWERHEAD IS NOT DESIGNED TO DRIVE EARTH ANCHORING DEVICES.

233-5093

*Replacement Parts Diagram
 14 Thru 18 Inch Diameter Auger Bits
 7/8 Inch Square Drive Connection
 For Use With BRPA270H Auger*

Reference Number	Part Number	Description	Application	Quantity
1	BR10627	Pak3, Pin, Auger, .312D	BR10600 Thru BR10602	1
2	233-5093	Decal, Caution, Clear Rotating	All Augers	1
3	15051200	HHCS, 5/16-18 X 1-1/2, ZY	BR10600 Thru BR10602	1
4	52050000	Nut, Lock, 2-Way, 5/16-18, ZY	BR10600 thru BR10602	1
5	RLPAK21	Pak21, Lock, Rubber	BR10600 Thru BR10602	As Req.
6	BR10615	Pak7, Tooth, Dirt, Hardfaced, (Includes 7 Each PN: RL, Lock, Rubber)	BR10600 Thru BR10602	As Req.
7	BR10619	Pak3, Bit, Screw, Auger, (Includes Ref. 3 & 4)	BR10600 Thru BR10602	1

*THIS PAGE INTENTIONALLY
LEFT BLANK*