



TRUCK AND VAN EQUIPMENT

REPLACEMENT PARTS

POWDER COATED STEEL RACK
UTILITY BODY TRUCK
MODEL 1225

WWW.WEATHERGUARD.COM

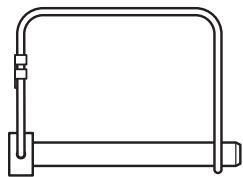

728
Rear Crossmember
Hitch Pin

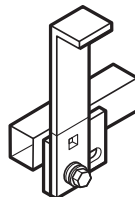

7586-5 (Black)
Ladder Stop

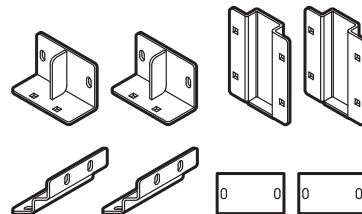

7724-5 (Black)
Mounting Bracket Kit

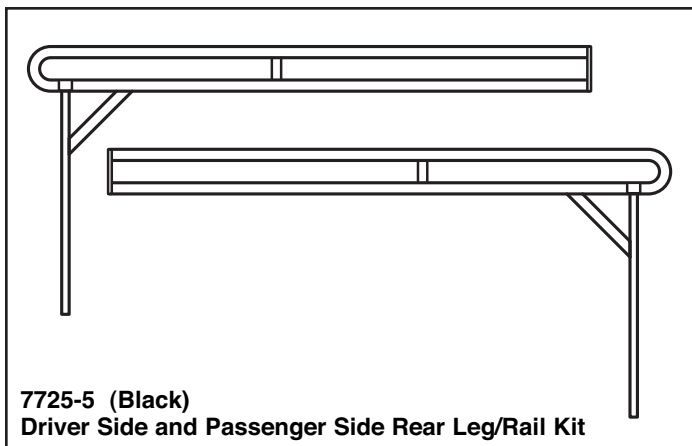

7725-5 (Black)
Driver Side and Passenger Side
Rear Leg/Rail Kit

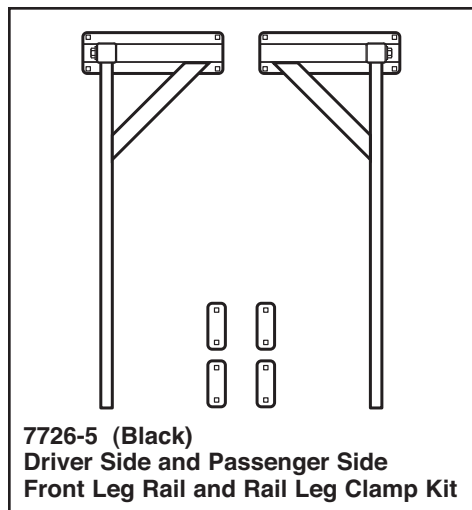

7726-5 (Black)
Driver Side and Passenger Side
Front Leg Rail and Rail Leg Clamp Kit

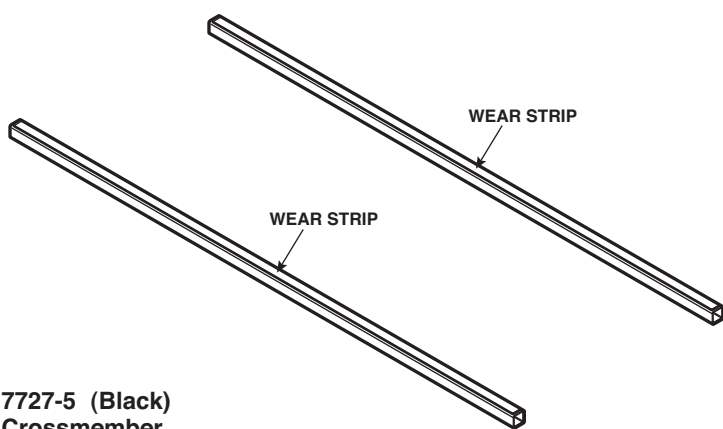

7727-5 (Black)
Crossmember

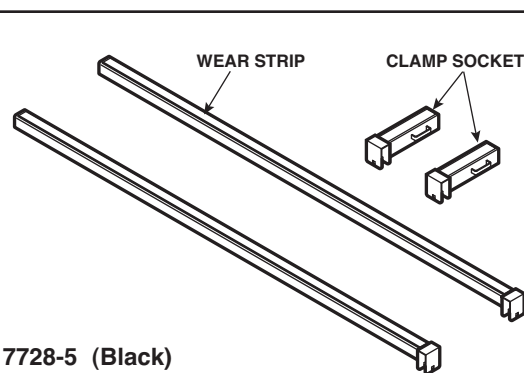

7728-5 (Black)
Crossmember

3/4"W x 48"L Roll



7843
Mounting Cushion

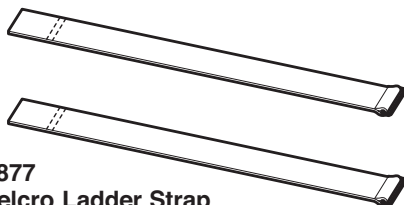





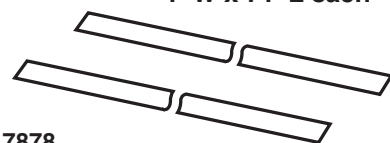





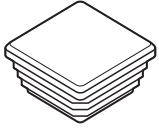

7877
Velcro Ladder Strap

1"W x 71"L each

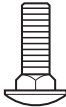
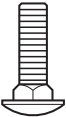

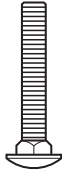
7878
Wear Strip

							
3/8-16 Nylon Lock Nut	5/16-18 Nylon Lock Nut	10-24 Nylon Lock Nut	3/8" Flat Washer	5/16" Flat Washer	Sealant	4-1/4" Rope Cleat	1-1/2" Square Cap Plug
(28)	(12)	(8)	(28)	(12)	(1)	(4)	(2)
							
3/8-16 x 3/4" Thread Cut Bolt	10-24 x 2-3/4" Slot Head Screw	3/8-16 x 1-1/4" Carriage Bolt	3/16-18 x 1-1/2" Carriage Bolt	5/16-18 x 1" Carriage Bolt	5/16-18 x 2" Carriage Bolt	5/16" x 2-3/4" Snapper Pin	
(4)	(8)	(4)	(24)	(8)	(4)	(2)	
							7729-5 (Black) Bolt Kit

MODEL	DESCRIPTION	QUANTITY	MODEL
728	Rear Crossmember Hitch Pin	1	728
7586-5	Ladder Stop (Black)	1	7586-5
7724-5	Mounting Bracket Kit (Black)	Kit	7724-5
7725-5	Rear Rail Kit (Black)	Kit	7725-5
7726-5	Front Leg Kit (Black)	Kit	7726-5
7727-5	Crossmember (Black)	2	7727-5
7728-5	Front Crossmember Kit (Black)	Kit	7728-5
7729-5	Bolt Kit (Black)	Kit	7729-5
7843	Mounting Cushion	Roll	7843
7877	Velcro Ladder Strap	2	7877
7878	Wear Strip	2	7878
24-0135	Instruction Manual	1	24-0135

Call Toll Free 1-800-456-7865, Fax Toll Free 1-800-334-2981



**KNAACK
MANUFACTURING CO.**
420 E. Terra Cotta Ave, Crystal Lake, IL 60014
815 459-6020, Fax 815 459-9097